

The Wireless World

THE PRACTICAL RADIO & TELEVISION JOURNAL

4^D



Friday, April 2nd, 1937.

**New receivers better than ever—
No increase in price!**

The new range of McCarthy all-wave receivers include several improved features, giving still better performance with no increase in prices!

There are also a number of new models (technical details ready shortly). Write for the McCarthy Catalogues, containing illustrations, full specifications, circuit diagrams, details of loud speakers, cabinets, etc., to:—



MCCARTHY
RADIO LTD.

44a, Westbourne Grove, London, W.2
Telephone: Bayswater 3201/2.

SEE ADVERTISEMENT INSIDE →

MOULDED MICA CONDENSERS



CAPACITY μF	PRICE EACH
.00005 - .0003	8d.
.0005	9d.
.001 and .002	1/-

350v. D.C. PEAK WORKING. 750v. A.C. TEST
You will find the wire terminals to these condensers a great help. They increase the speed and ease of assembly considerably.

DUBILIER

Dubilier Condenser Co. (1925) Ltd., Ducon Works, Victoria Rd., North Acton, London, W.3. C. H. Casson 10

HAYNES QUALITY RECEIVERS

Demonstration night—every Friday,
7.30—9.30 p.m.

Originators of the Quality Receiver.



Have you the Haynes Quality Booklet?
1936-37 Edition.

QUEENSWAY, ENFIELD, MIDDLESEX.
Enfield 2726

Central London area Agent, London Radio Supply Company, 11, Oat Lane, E.C.2.
Hire purchase arranged.

Sound Sales Limited

Manufacturers of

REALLY HIGH QUALITY AMPLIFIERS,
HIGH GRADE TRANSFORMERS OF ALL TYPES

and

LOUD-SPEAKERS WITHOUT A "DIALECT."



MARLBOROUGH ROAD,
UPPER HOLLOWAY,
LONDON, N.19.

LIMITED.

(Contractors to the
G.P.O., etc.)

Tel.: Archway 1661/2/3.



Sound dry—but they're interesting

Making a really efficient Dry Electrolytic Condenser is a more interesting job than you may think. So many things to be watched—so many things that need our years of experience. Our selection of special foil, our unique method of preparing and pre-forming it, the making and application of electrolyte, the assembly of the sections, the forming processes of the condensers, the careful electrical measurements and tests—all small things, but they mean so much.

In addition to multiple methods of sealing, we also use a resilient wax of great adhesion to seal our condenser sections, thus avoiding cracks in rough handling. Yes, another small point—but they all mount up into the reason why Dubilier Dry Electrolytic Condensers have low power factor, low leakage current and high safety factor.

DUBILIER

CONDENSERS

DUBILIER CONDENSER CO. (1925) LTD., DUÇON WORKS VICTORIA ROAD, NORTH ACTON, LONDON, W.3



C. R. Casson 123

Mention of "The Wireless World," when writing to advertisers, will ensure prompt attention.

The Wireless World

THE
PRACTICAL RADIO
JOURNAL
26th Year of Publication

No. 918

FRIDAY, APRIL 2ND, 1937.

VOL. XL. No. 14.

Proprietors : ILIFFE & SONS LTD.

Editor :
HUGH S. POCKOCK.

Editorial,
Advertising and Publishing Offices :
DORSET HOUSE, STAMFORD STREET,
LONDON, S.E.1.

Telephone : Waterloo 3333 (50 lines).
Telegrams : "Ethaworld, Sedist, London."

COVENTRY : Hertford Street.

Telegrams : "Autocar, Coventry." Telephone : 5210 Coventry.

BIRMINGHAM :

Guildhall Buildings, Navigation Street, 2.
Telegrams : "Autopress, Birmingham." Telephone : 2971 Midland (4 lines).

MANCHESTER : 260, Deansgate, 3.

Telegrams : "Iliffe, Manchester." Telephone : Blackfriars 4412 (4 lines).

GLASGOW : 26B, Renfield Street, C.2.

Telegrams : "Iliffe, Glasgow." Telephone : Central 4857.

PUBLISHED WEEKLY. ENTERED AS SECOND
CLASS MATTER AT NEW YORK, N.Y.

Subscription Rates :

Home, £1 1s. 8d. ; Canada, £1 1s. 8d. ; other
countries, £1 3s. 10d. per annum.

*As many of the circuits and apparatus described in these
pages are covered by patents, readers are advised, before
making use of them, to satisfy themselves that they would
not be infringing patents.*

CONTENTS

	Page
Editorial Comment	315
Hard Valve Time Bases	316
Current Topics	319
Magnetic Focusing	320
Random Radiations	322
Listeners' Guide for the Week ..	324
The Cathode-Ray Oscillograph ..	326
Electrostatic Focusing	328
New Apparatus Reviewed	330
Cathode-Ray Tube Characteristics	331
On the Short-Waves	335
Fluorescent Screens	336
Broadcast Brevities	338
Letters to the Editor	339
Recent Inventions	340

EDITORIAL COMMENT

Cathode - Ray

The Heart of Television

THE appearance of our present issue, devoted mainly to the subject of the cathode-ray tube, reminds us that the general public scarcely knew of the existence of such a device as the cathode-ray tube until, with the arrival of television, they constantly heard the name of "cathode-ray tube" coupled with every discussion on the new art. But the cathode-ray tube is not new in principle; it was well known before 1897, and it was in that year that Braun produced a useful laboratory instrument from what had been merely an interesting experiment in physics. The Braun tube, although it may be regarded as the first of its dynasty, had a limited appeal, even to scientists. At that time it was not a very reliable or permanent instrument nor had valuable applications for it yet been found.

It was not until about thirty years later that the cathode-ray tube came to be regarded as an every-day instrument in the laboratory, although as long ago as 1902 Cossors, the valve manufacturers, were producing their first examples.

Wehnelt introduced the heated cathode to the tube in 1905, and this was an outstanding development. Other pioneers were van der Bijl and Johnson, the latter having been the designer of the Western Electric oscillograph produced about 1920. Von Ardenne, in Germany, has been responsible for several of the most important refinements of the modern tube, and his work has contributed to a very large extent in making these tubes suitable tools for use in television reception.

Television has given impetus to tube development during the past few years, and in just the same way it may be said that every fresh improvement in the tube has contributed to hastening the arrival of efficient television. If it had not been for television, the tube would probably still have remained an undeveloped instrument for the reason that the demand for it commercially would have been insufficient to encourage extensive research on it, nor should we to-day be enjoying a television service if the cathode-ray tube had not been available to us.

Great strides have been made in cathode-ray tube development, but finality has by no means been reached and we may look for important progress to continue for some time to come. Records at the Patent Office are, in themselves, an indication of the inventive effort which is being put into this instrument at the present time.

Information in this Issue

Technically speaking, there are two rival cathode-ray tube systems available for television, and both are being used commercially at the present time. One employs electrostatic focusing and electrostatic deflection, and the other magnetic focusing and deflection. Articles in this issue discuss these systems and point out their merits. Other contributions deal with various problems associated with the practical use of these tubes, both for television and laboratory requirements. Details of the various types of tube available to-day, with a key to their base connections, provides, in a convenient form, a great deal of information which has not, we believe, been available hitherto.

Hard-valve Time-bases

A TIME-BASE or, to give it its full title, a time-base oscillation generator, consists essentially of a condenser connected via a controlling resistance across a direct current source of supply. Across the condenser is connected a discharging device.

The simplest form of discharging device is an ordinary neon glow lamp. Such a simple form of time-base is inefficient because there is only a small potential difference between the striking and extinction potentials of the neon lamp and also because the charging curve is exponential and not linear.

The introduction of a grid into the neon lamp by Dr. Hull introduced a useful tool known as a Thyatron, which very greatly increased the difference between the striking and extinction potentials and thus increased the efficiency of the time-base. Dr. Hull also replaced the neon gas by mercury vapour.

The linearity of the charging curve was slightly improved by replacing the resistance by a diode having a plain metal filament operated with the filament current reduced so that the space current is saturated, i.e., independent of the anode voltage. A further great improvement was effected by Bedford, whose substitution of the diode by a pentode operating on the flat part of its anode-volts—*anode-current* characteristic increased the linearity enormously.

The characteristic curve mentioned above is shown in Fig. 1, from which it will be obvious that, provided the anode volts are not permitted to fall below about 50 volts, the anode current is substantially, though not completely, independent of the anode voltage.

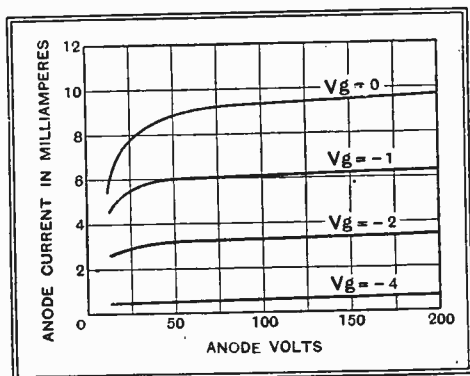

Fig. 1.—Typical anode-volts—*anode-current* curves for an RF pentode are shown here.

Bedford's later development¹ of applying a small potential, proportional to the anode current, to the grid-cathode circuit of the pentode provides almost perfect

¹ British Patent Specification No. 451117, A. C. Cossor and L. H. Bedford.

HOW ORDINARY VALVES CAN BE USED AND THEIR ADVANTAGES

By O. S. PUCKLE, A.M.I.E.E.

(Cossor Research Laboratory)

linearity of the condenser charging curve.

All these improvements, however, though of inestimable value, do not prevent the soft-valve time-base from lying open to the charges of erratic behaviour and of an inability to function at all except at relatively low frequencies. Furthermore, the soft-valve time-base refuses to function at rapidly varying frequencies, a condition which is sometimes necessary, e.g., for velocity modulation television.

ALTHOUGH gas-filled triodes are widely used in time-bases, ordinary hard valves can be employed and offer certain advantages at high frequencies. In this article, circuits of several types are given and their mode of operation explained

The reason for the above mentioned failures of the soft-valve time-base is that before the gas or vapour can conduct a current it must become ionised. Ionisation takes place when the potential across the electrodes immersed in the gas is raised to a certain critical value. This critical potential depends upon a number of factors:—

- The actual gas or vapour used and its purity.
- The pressure of the gas.
- The temperature.
- The rate of rise of potential.
- The time which has elapsed since the gas was last ionised.

It will be obvious that the temperature of the valve will rise after the circuit is switched on and hence the pressure of the gas will vary. In the same way a draught of air will tend to upset the operation of the time-base. Since the ionisation potential varies with the rate of rise of potential a soft-valve time-base does not function satisfactorily in a velocity modulation television system where the time taken to charge the condenser, and hence the rate of rise of potential, is constantly varying.

As the time between successive discharges is reduced a limiting condition is reached in which the gas has not sufficient

Fig. 2.—A time-base in which a saturated diode is used to maintain linearity.

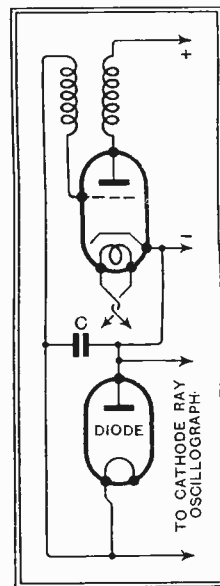

time to become de-ionised, so that the discharge valve continues to carry current and the condenser cannot charge. There is thus a limiting frequency at which the time-base can function with a given pressure and temperature of the gas or vapour in the discharge tube. This limiting frequency is normally about 30,000 discharges per second.

It is believed that the first hard-valve time-base was that due to Watson-Watt and Herd of the Radio Research Board.

The Watson-Watt Herd time-base (Fig. 2) consists of a RF oscillator which is made to oscillate very violently. A grid blocking-condenser C is shunted by a diode, the former becoming charged when the grid of the oscillator is driven towards zero grid volts. The condenser acquires sufficient potential to stop the oscillations and these do not recommence until the charge on the condenser is greatly reduced by leakage through the diode. The rate of leakage is controlled by varying the temperature of the diode and the resultant potential variations across the condenser are normally fed to the horizontal deflecting plates of a cathode-ray tube in order to produce a motion of the spot which is proportional to time.

Time-base Circuits

The diode shown in Fig. 2 may, of course, be replaced by a pentode in order to improve the linearity, as described above.

Notice that in the case of the Watson-Watt Herd time base the condenser is discharged by the diode or pentode. This arrangement is the opposite to that normally used, but it should be borne in mind that a time-base potential may be obtained by a slow charge of the condenser followed by a rapid discharge or alternatively by a rapid charge followed by a slow discharge. The effective portion of the charge-discharge curve is normally the slow portion.

Other time-bases using hard valves have

Hard-valve Time-bases

been developed, notably by Knoll, Freundlich and Turner. Several of these consist of a condenser charged from a DC source of supply, the condenser being discharged by the application of a potential between the grid and cathode of a valve connected across the condenser. The grid of the valve is normally biased beyond anode-current cut-off so that no current flows through the valve during the charging period and the condenser is discharged when required by making the grid positive. Such a time-base is known as a "single stroke" time-base and is of great value for examining transients and other phenomena which occur at rare intervals. It is, of course, usual to make the transient apply the positive bias and so trigger the time-base.

In order to make such a time-base self-acting it is necessary to make it provide a potential which is suitable for application to the grid of the discharge valve. This has been done in the Cossor time-base.²

The fundamental circuit of the Cossor time-base is shown in Fig. 3, in which V1 is a pentode valve arranged to charge the condenser C, and V2 is the discharging valve. The valve V3 functions chiefly as a phase-reverser and may be replaced by a transformer, although this considerably reduces the flexibility of the time-base.

Assuming that the condenser C is in the discharged condition there is then no potential across the valve V2 and hence no anode current flows. For this reason the valve V3 will be at zero grid potential and will pass a heavy current so that the voltage on its anode will be low. The resistance R2 in the anode of V3 is a high

a negative potential to the grid of V3 and causes the potential on the grid of V2 to rise with a consequent increase of anode current through the resistance R1. The effect is thus a cumulative one and brings about an extremely abrupt change from the charging to the discharging condition. When the potential across the condenser has fallen to a low value the anode current through V2 and R1 falls, since the potential has become insufficient to maintain it, and a positive pulse is fed to the grid of V3. As a result of this action the potential on the anode of V3 and hence on the grid of V2 falls, thus biasing V2 beyond

Furthermore, this time-base is considerably more stable and flexible in operation than is a gas-filled time-base. A more detailed account of the circuit will be found in the Journal of the Television Society, Vol. 2, Part V, June, 1936.

When a time-base is used in conjunction with a high-vacuum cathode-ray tube

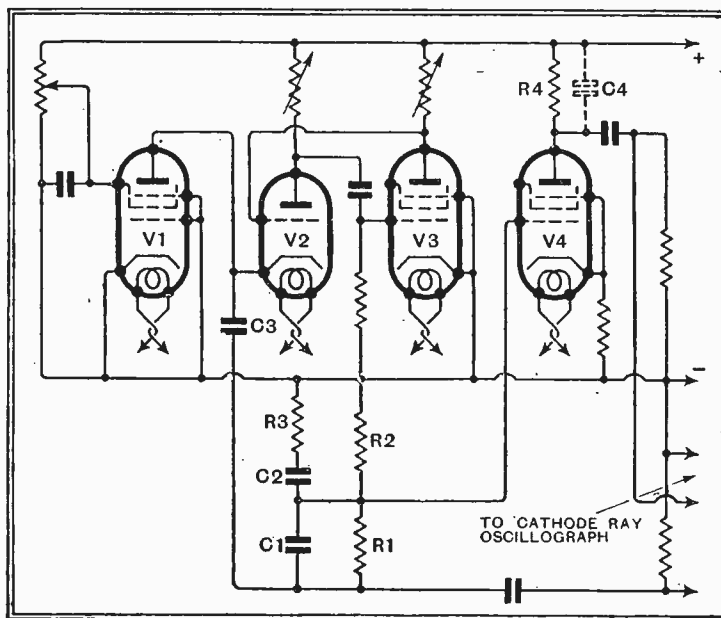

Fig. 4.—A hard-valve time-base with push-pull output is shown here. Again the RF pentode V1 ensures a linear change of voltage across the condensers C1 and C2.

cut-off and allowing the condenser C to become charged once more.

The resistance R1 controls the rapidity of change-over from the charging to the discharging condition and vice-versa, and at the same time it controls the rate of discharge since it tends to limit the anode current of V2.

The resistance R2 controls the potential of the grid of V2 during the charging period and hence determines the potential to which the condenser shall charge.

The application of a negative pulse to the suppressor grid of V3 (in which case V4 may be omitted) or of a positive pulse to the grid of V4 will

Fig. 3.—In this time-base circuit, V1 is the charging valve, while V2 and V3 form the discharging device; V4 is for synchronising.

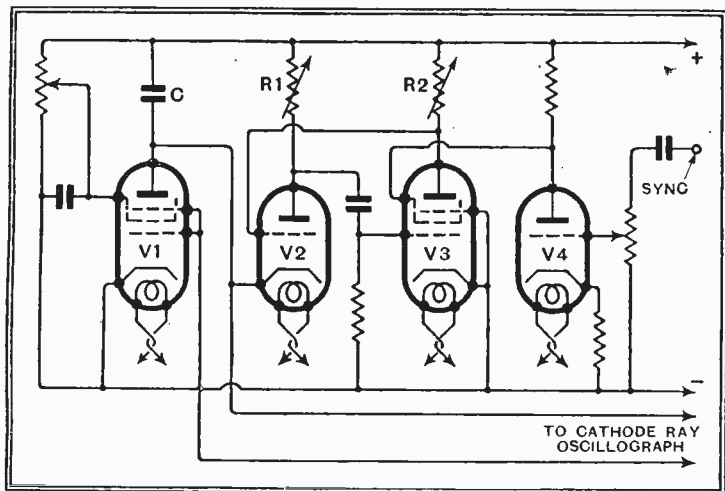

one and when the grid of V3 is at zero potential its anode voltage will be about 100 volts when the high tension supply is 400 volts. There is thus a voltage drop of, say, 300 volts across R2 and this is applied directly to the grid of V2.

As the condenser C commences to charge, the voltage across V2 increases until the charge rises to nearly 300 volts, when the valve V2 commences to pass anode current. The passage of anode current through the resistance R1 applies

initiate the discharge of the condenser C. Hence, if the wave form being examined, or the synchronising portion of a television signal, be applied to either of these points the time-base can be synchronised.

This time-base has a frequency range extending from several seconds or more per cycle to 250,000 cycles per second. This high frequency compares very favourably with the 30,000 cycles per second obtainable with a gas-filled valve time-base, and permits of the examination of individual waves having a frequency as high as 5 or 10 megacycles per second.

it is necessary to resort to push-pull operation of the time-base. This may be carried out in several ways. A condenser may be charged in a linear manner to a small potential which may be amplified by means of a paraphase amplifier to provide a push-pull output.³ Alternatively, the condenser may be charged in a linear manner to a high potential and a single stage amplifier having unity gain may be added to function as a phase-reverser. Such a scheme is depicted in Fig. 4.

The condenser C is replaced by a potentiometer consisting of two condensers which are charged by V2 and discharged by V1, and these are shunted by resistances so that no frequency distortion is introduced. This condition exists when $\frac{C_1}{C_2} = \frac{R_2}{R_1}$. The condenser C2 includes the stray grid capacity of the valve V4 and the wiring thereto. C3 is a blocking condenser and is intended to keep DC from the grid of V4. The ratio $\frac{C_2}{C_1}$ is made

equal to the gain of the valve V4 in order that the voltage swing on the anode of V4 shall equal that on the anode of V1. The resistance R4 has necessarily a stray capacity C4 across it and this tends to reduce the gain of V4 at the higher frequencies. This effect is almost completely compensated by the insertion of the resistance R3. The latter resistance is adjusted so that the time-constant R3C2 is equal to that of R4C4. Alternatively, the stray capacity C4 may be compensated by an inductance in series with it.

A further method of obtaining a push-pull output is to charge the condenser in a non-linear manner, thus saving expense,

² British Patent Specification No. 419398, A. C. Cossor and O. S. Puckle.

³ Television Reception, Manfred von Ardenne. Chapman and Hall, London.

Hard-valve Time-bases

since the condenser may be charged through a resistance instead of a pentode, and to straighten the characteristic curve by amplifying in a non-linear manner as shown in Fig. 5.

Assume that the condenser charging curve is as shown in Fig. 5. If the difference between this curve and a straight line is plotted the resultant amplifier output curve will be found to be similar to a valve curve, and it is, therefore, possible to make a valve having a characteristic which is suitable for linearity correction.

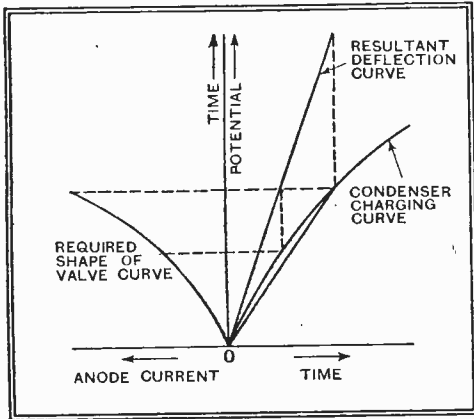

Fig. 5.—Instead of using a charging valve to obtain a linear output, the subsequent amplifier can correct for non-linearity if its characteristic is suitable.

Another form of hard-valve time-base, due to Kobayashi,⁴ is shown in Fig. 6. A valve oscillator discharges the condenser in this instance, a reversal of the procedure adopted by Watson-Watt and Herd. The condenser C is charged through the high resistance R and when the potential across it is sufficiently high the valve, which is normally biased beyond cut-off, commences to pass anode current so that the transformer applies a positive potential to the grid and so brings about a rapid increase of anode current. This circuit when

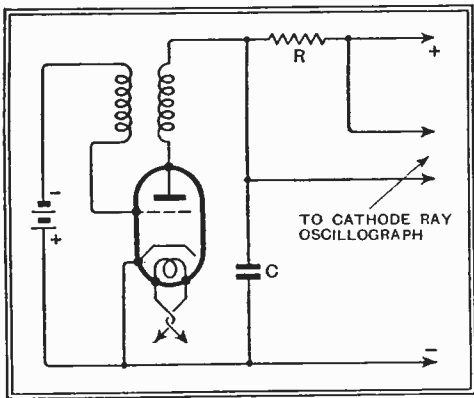

Fig. 6.—One of the simplest of hard-valve time-bases is shown here. It employs only a single valve.

arranged to give a push-pull output is useful for television reception, but it tends to be limited in frequency range and flexibility and is not particularly suitable for general oscillographic work.

⁴ U.S.A. Patent Specification No. 1913449, Kobayashi.

In Next Week's Issue

AC Short-Wave Converter

FOR THE CONSTRUCTOR

Waverange
12.5
to
62.5
Metres

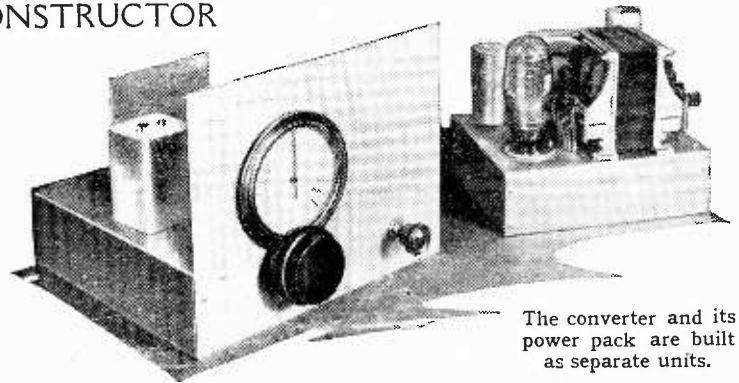

The converter and its power pack are built as separate units.

THIS is a superheterodyne short-wave converter, designed for AC mains operation, and it can be used with any type of broadcast set, though in the case of straight sets at least one RF stage must be included.

It covers a waveband of 12.5 to 62.5 metres in three ranges, and the coils and switches are contained in a separate unit, though this unit actually forms a part of the main chassis.

A triode-hexode frequency-changer is

used with the signal circuit tuned, and its condenser is ganged with that of the oscillator. Fixed series tracking condensers are employed, and only the parallel padding condensers require adjusting to give the correct coverage on each range.

A separate power supply unit is provided in order to render the converter independent of other supply sources, and this also ensures that the correct voltages are applied to the various electrodes in the valve.

LIST OF PARTS.

- Certain components of other makes but of similar characteristics may be used as alternatives to those given in the following list.*
- 2 Variable condensers, 100 mmfds. Eddystone 900
 - 2 Flexible couplers Eddystone 1009
 - 1 Condenser drive, two-ratio Eddystone 1070
 - 2 Stand-off insulators Eddystone 1019
 - 1 Valve holder, 7-pin, without terminals Clix Chassis Mounting S.W. Type V5
 - 1 Group board, 5-way Bulgin C31
 - Condensers:
 - 3 0.1 mfd., tubular T.C.C. 250
 - 2 0.01 mfd., mica T.C.C. "M"
 - 1 0.0001 mfd., mica T.C.C. "M"
 - 2 0.001 mfd., mica, tolerance ± 5 per cent. T.C.C. "M"
 - Resistances:
 - 1 50 ohms, $\frac{1}{2}$ watt Erie
 - 1 25,000 ohms, $\frac{1}{2}$ watt Claude Lyons
 - 1 30,000 ohms, $\frac{1}{2}$ watt Claude Lyons
 - 1 50,000 ohms, $\frac{1}{2}$ watt Claude Lyons
 - 1 400 ohms, 1 watt Claude Lyons
 - 1 10,000 ohms, 1 watt Claude Lyons
 - 1 70,000 ohms, 1 watt Claude Lyons
 - 1 10,000 ohms, 2 watts Claude Lyons
 - 1 15,000 ohms, 3 watts Claude Lyons
 - 1 Trimming condenser, single type, 500 mmfds. max. Hunts 3276TD
 - 1 Connector, four-way Bryce Light Pattern
 - 1 Plug-top valve connector Belling-Lee 1175
 - 2 Switches, 2-pole 3-way with earthing plate and tag B.T.S.-B123FET
 - 1 Switch rod and locator, 7in. long B.T.S.
 - 2 Multiple strip condensers, 3-way, 30 mmfds. Bulgin SW101
 - 2 Coil formers, $\frac{1}{2}$ in. dia. \times 2 $\frac{1}{2}$ in. long, threaded 12 tpi. B.T.S.
 - 2 Coil formers, $\frac{3}{4}$ in. dia. \times 2 $\frac{1}{2}$ in. long, threaded 14 tpi B.T.S.
 - 2 Coil formers, $\frac{3}{4}$ in. dia. \times 2 $\frac{1}{2}$ in. long, plain B.T.S.

- 1 Coil former, 1in. dia. \times 2in. long, plain B.T.S.
- 2 Terminals, ebonite shrouded Belling-Lee "B"
- 1 Aluminium coil screen, 2 \times 2 \times 3in. Goltone R9/238
- 1 Battery cable, 4-way Bulgin BC2
- 1 Plug, 4-pin Bulgin P9
- 1 Length screened sleeving, 2 mm. Goltone R39/281
- Miscellaneous: Peto-Scott
 - 3 lengths systoflex; small quantity Nos. 18 and 20 enamel wire, Nos. 20 and 34 D.S.C. wire, Nos. 16 and 18 tinned copper wire, Aluminium for coil unit, chassis, partitions, valve bracket, condenser support and panel. Small ebonite bracket for condenser, 6BA studding, etc. Screws: 24 $\frac{1}{4}$ in. No. 6 R/hd., 12 $\frac{1}{2}$ in. No. 6 R/hd., 8 in. No. 6 R/hd., all with nuts and washers; 2 6BA with 8 nuts and washers.
- Valve: Mazda
 - 1 AC/TH.1

POWER PACK.

- 1 Mains transformer: 250-0-250 volts, 60 mA., 4 volts, 2.5 amps., centre tapped, 4 volts, 2/3 amps. All Power PT/AP
- 1 Smoothing Choke, 15 henries, 25 mA Bulgin LF17S
- 1 Condenser, dry electrolytic, 8 mfd., 500 volts peak Polar-N.S.F.
- 1 Condenser, dry electrolytic, 4 mfd., 500 volts peak Polar-N.S.F.
- 2 Valve holders, 5-pin, chassis type Bulgin VH13
- Miscellaneous: Peto-Scott
 - 3 lengths systoflex; small quantity Nos. 16 and 20 tinned copper wire, aluminium for chassis, etc. Screws: 22 $\frac{1}{4}$ in. No. 6 R/hd., 6 $\frac{1}{2}$ in. No. 4 R/hd., all with nuts and washers.
- Valve: Mazda
 - 1 UU4

Warning to Pirates

THE fact that several portable trans-receivers have appeared on the market both in this country and abroad has apparently led many people to believe that they can be purchased and used with no more formality than an ordinary receiver. The G.P.O. is anxious to emphasise the fact that not only are transmitting licences necessary before such apparatus can be used, but that these licences are only granted for bona fide experimental purposes.

Japanese Wireless Merger

THE two great radio communication concerns in Japan, namely, the Japanese Wireless Telegraph Co. and the Japan International Telephone Co., are to join forces. This amalgamation is taking place at the express wish of the Government, which desires to unify the control of Japan's international communications.

Denmark Reorganises

ON April 1st Danish broadcasting passed under the control of a new director-general assisted by three other directors. The new director-general, Mr. F. E. Jensen, is an ex-Government official and his attention will be mainly directed to the business side of broadcasting. Although Mr. Jensen is practically unknown to the man-in-the-street he has long been a popular figure at Danish broadcasting headquarters.

Air Force Amateurs

THOSE overseas members of the R.A.F. who indulge in radio transmitting as a hobby will shortly be able to keep in touch with the Home Country through the new amateur experimental station at Cranwell. This station has been erected by members of the Air Force who belong to the Cranwell Amateur Radio Transmitting Society. Its call sign is G8FC.

R.S.G.B. Activities

A DEAD-HEAT occurred in the 1.75 Mc. competition held by the Radio Society of Great Britain in January. The operators of G5ZT (Preston) and G6BQ (Gravesend) both scored 70 points and will each hold the Society's Challenge Trophy for six months.

The Society's fifth national field-day, an annual event to make amateurs familiar with the use of portable apparatus under conditions of emergency, will be held during the first week-end in June. In addition, a new event will be held this year, namely, a five-metre national field-day. This will be held on July 4th.

Current

The P.M.G. Recognises Scotland

MANY years ago Scottish amateurs used to employ the letter "C" (Caledonia) following the official British prefix "G," but this was entirely unofficial. The P.M.G. has now recognised the separate existence of Scotland by issuing call-letters with the letter "M" following the "G." Amateurs in Northern Ireland use "GI," but Wales still has no distinguishing letter, being compelled to share the plain "G" with England.

Fire Engine Radio

THE latest use to which wireless has been put is to enable fire engines to keep in direct touch with headquarters so that they can report the extent of fires which they are attending and so enable the powers-that-be to determine whether engines from other depots should be sent to help. Cape Town is the city responsible for this innovation. The apparatus is operated from a motor-generator, driven from a storage battery.

Automatic Alarm Device

FOLLOWING the example set by this country many years ago America is now to bring her marine radio up to date by installing an automatic alarm device on ships carrying one

Topics

distress signal be picked up during the operator's watch below. Actually it is set to take account of a series of dashes, each of four seconds' duration, separated by an interval of one second. The great disadvantage of this type of apparatus when first introduced on board British ships was that it was prone to sound the alarm at times when no distress signal was coming in. This naturally tended to discredit it, and after the operator had been needlessly roused from his bunk several times during the night he was sorely tempted to disconnect it.

Cup Final Commentary in Swedish

SO great is the interest taken in British football in Sweden that a special commentator is to be sent over to Wembley on May 1st to give a running commentary in Swedish. The microphone will, of course, be connected by a wire with the Swedish broadcasting headquarters. Similar arrangements have been made in connection with the commentary on the Coronation, although in this case, of course, the Swedish broadcaster will be

NEWS OF THE WEEK IN BRIEF REVIEW

No Free Wireless for the Bedridden

REPLYING to a question in the House of Commons the P.M.G. stated that it had not been found possible to extend the issue of free wireless licences to the bedridden and other classes of the community deserving of sympathy. The whole question was, he added, reviewed by the Broadcasting Committee of 1935 which advised against the issue of free licences to persons other than the blind.

More Dishonest Servicing

IT was reported recently that several dishonest servicemen had been prosecuted in Denmark as a result of the attention drawn to the matter by reports appearing in *The Wireless World* concerning dishonest servicing practices in New York. Further investigations in Denmark have revealed the fact that Danish listeners are being robbed of at least £5,000 sterling every year by these radio rogues.

Television Programmes

FROM the commencement of the regular public television transmissions on November 2nd to the middle of March the B.B.C. radiated some 900 programme items covering a period of 240 hours. Forty-three per cent. of this time was taken up by variety, drama, ballet and other stage entertainments. Twenty-five per cent. was devoted to "illustrated" talks on general, topical and special subjects. Film items accounted for 22 per cent. of the time, women's interests occupying 6 per cent. Art topics accounted for the remaining time.

It is reported by the G.E.C. that over 65,000 persons have attended the demonstrations given by the Company and its dealers. At Magnet House, Kingsway, where free shows are given daily, there have been 5,000 visitors, over 90 per cent. of them being men.

I.E.E. Lectures

NEXT Wednesday (April 7th) at 6 p.m. a lecture on some aspect of a wireless subject not yet announced will be given by Dr. B. van der Pol. On Thursday evening at 6 p.m. Mr. D. Robertson, M.A., B.M., M.R.C.P., will give a lecture on the "Examination and Recording of the Human Electrocardiogram by Means of the Cathode-ray Oscillograph."

THE EAR AND THE EYE of N.B.C. Television. The R.C.A. Iconoscope may look simple but it is the link between the real and the radio picture in America.

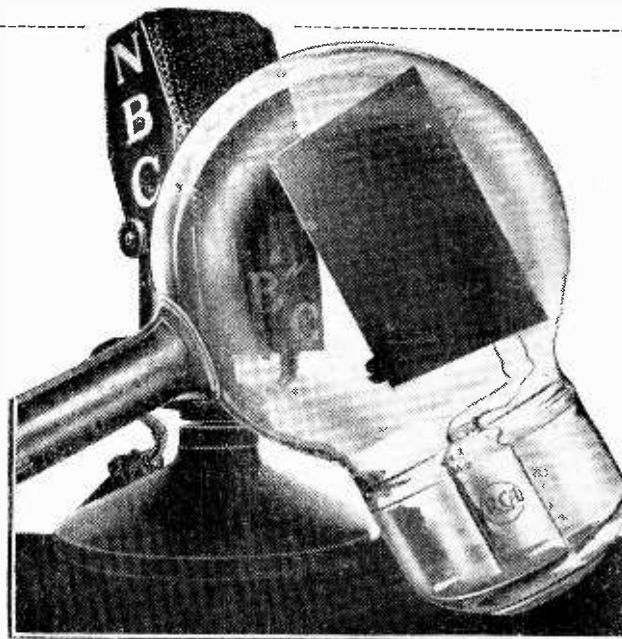

operator. This arrangement sounds an alarm bell on the bridge and elsewhere should a

only one among many others describing the Coronation in their own language.

Magnetic Focusing

ONE OF THE TWO METHODS OF CATHODE-RAY CONTROL USED IN TELEVISION RECEIVERS

By H. WOOD (Television Research, Ferranti, Ltd.)

BEFORE giving an explanation of the method used, and the theory of the action of the magnetic focusing coil, it might be useful to consider the construction of a television type CR tube. In Fig. 1 K is the emitting cathode, W the Wehnelt cylinder or control electrode, and A the single anode of a tube suitable for magnetic focusing and scanning. This is the whole of the simple

OF the two methods of focusing which are applicable to television-type tubes, electro-magnetic is the less widely known. The principle upon which it depends and its practical advantages are discussed in this article.

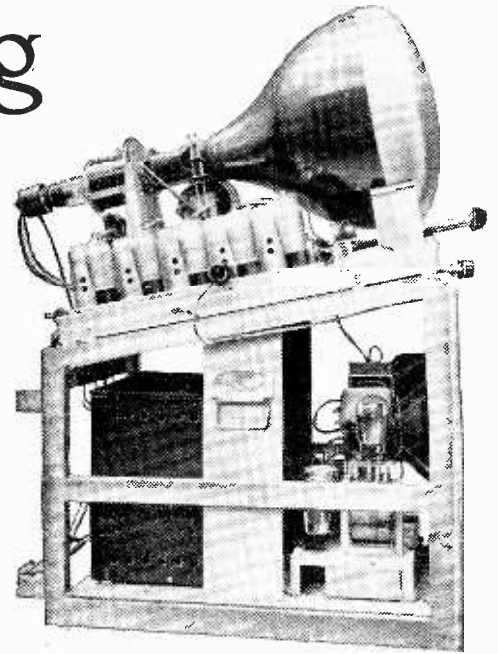

One of the Ferranti experimental television receivers.

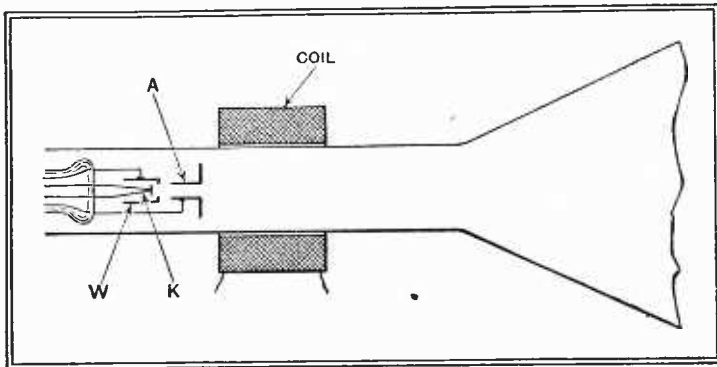

Fig. 1.—The relative positions of the electrodes and focusing coil are shown in this drawing.

at a point, thereby producing an intense light-spot. The desired field is produced by surrounding the neck of the tube immediately in front of the anode with a solenoidal coil of about 200-300 ampere turns. In a quite suitable design the coil is 3 inches long.

The coil may be energised by connecting it in series with a variable resistance across the HT supply of the receiver.

electrode system. But although the electrodes are few in number considerable thought has been given to their design. The Wehnelt cylinder which is used to control the intensity of the electron beam has to be designed so that the tube has a good linear characteristic for light intensity against Wehnelt potential with a sharp cut-off at each end.

Fig. 2 gives the characteristic of a Ferranti tube. The curve is nearly straight over the working range and the voltage base is short, only 25 volts from white to black, thus giving good sensitivity. At the

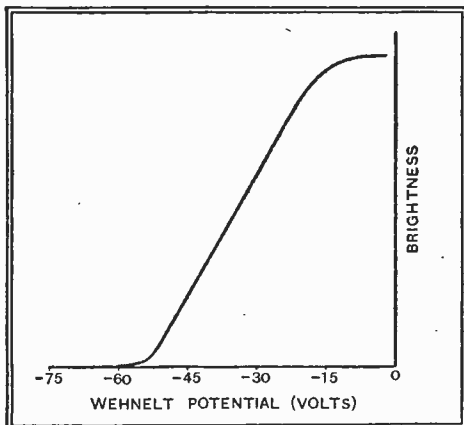
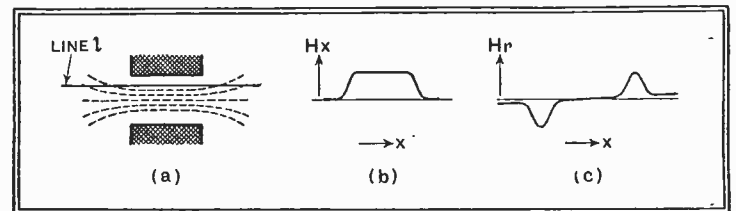

Fig. 2.—This curve shows the relation between the brightness of the spot and the grid voltage.

Fig. 3.—In these drawings the shape of the field produced by the focusing coil is shown.



same time, the cut-off at -50 volts is very sharp, ensuring really good blacks on the picture.

With regard to anode design, it is essential that the electron beam, which is accelerated by the anode and emitted from it as a conical divergent beam, shall be of the greatest possible intensity as this gives the brightest screen illumination. At the same time, the angle of divergence of the extreme edges of the beam must not be too great, otherwise the focusing cannot be good. The actual beam emitted in the Ferranti tube is such that, when unfocused, it produces a disc of light about 3 inches in diameter on the screen at full brilliance.

Method of Focusing

Focusing involves producing a magnetic field which will cause the electron beam, initially diverging symmetrically from the anode, to become convergent in such a way that the whole beam meets the screen

It is quite easy to see how the field of this solenoid causes the beam to become convergent. Fig. 3 (a) and (b) and (c) show the characteristics of the field of the coil. Fig. 3 (b) is a curve showing the field strength along the axis at all points.

Fig. 3 (c) shows field strength radially outward from the axis for points at a given small distance from the axis, i.e., pts. on line 1 in Fig. 3 (a).

Bearing in mind these curves, we now consider the behaviour of an individual electron which leaves the anode travelling

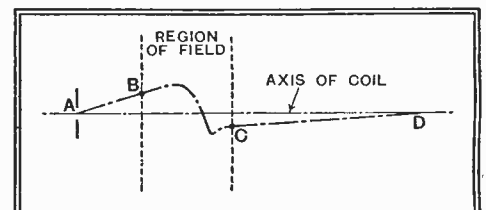

Fig. 4.—The path of an electron passing through the field is shown here.

Magnetic Focusing—

slightly away from the axis (see Fig. 4), and at a small distance from the axis enters the field.

We must first enunciate the law giving the force acting on a charge moving in a magnetic field. In its simplest form it relates to the case where the velocity of the charge and the field direction are perpendicular. In this case the force acting on the charge is $F = Hev$ where H is field, v velocity and e the charge. The direction of the force is perpendicular to both H and v , and its positive direction is given by Fig. 5.

Now in our particular case the velocity of the electron may be split into two components, a large velocity V_x along the axis and a small one V_r away from the axis.

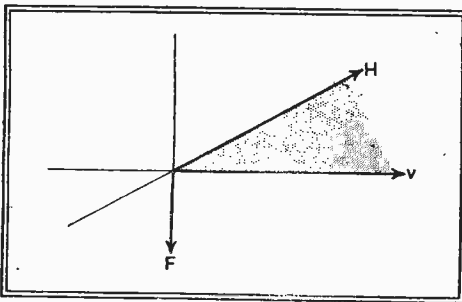

Fig. 5.—The force acting on a charge has two components acting in different directions.

Similarly, the field at any point may be split into two components H_x along the axis and H_r away from it, the values being given by Fig. 3 (b) and (c).

The components V_x and H_r are responsible for a force acting on the charge in the direction shown in Fig. 6 (a). Also, the components V_r and H_x are responsible for another force acting in the same or opposite direction (Fig. 6 (b)), depending upon the signs of V_r and H_r (i.e., $+vc$ or $-vc$). Under the action of these forces the electron rotates about the axis, and Fig. 7 shows the path as seen along the axis. The point X corresponds to where

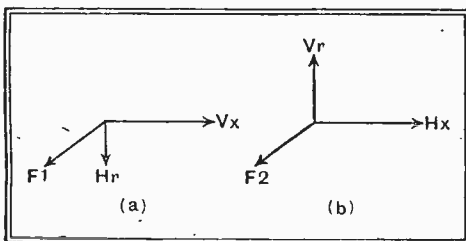

Fig. 6.—The forces which produce a rotational movement of the electron are shown here.

the charge leaves the field, after which it travels in a straight line. A complete investigation of the equations of motion of the electron shows that on emerging from the field it is going either directly towards or directly away from the axis. i.e., it cannot be going along any straight line which does not meet the axis. The same investigation shows that if the field is strong enough the electron is going to-

wards the axis and meets it at a point which is the same for all electrons leaving a common anode with the same velocity, provided that all these electrons are

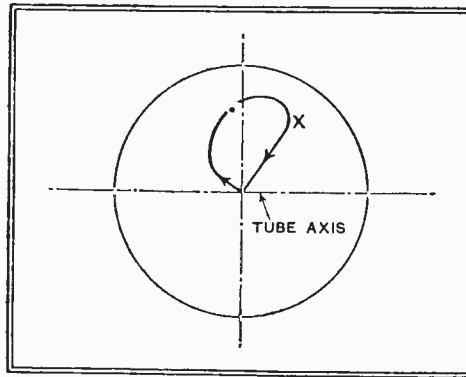

Fig. 7.—The path of the electron has a rotational movement as shown in this drawing.

initially only diverging at small angles from the axis.

In practice it is found desirable to put the coil in such a position that the anode is just within the fringes of the field. This probably has the effect of confining the beam to a rather smaller dimension,

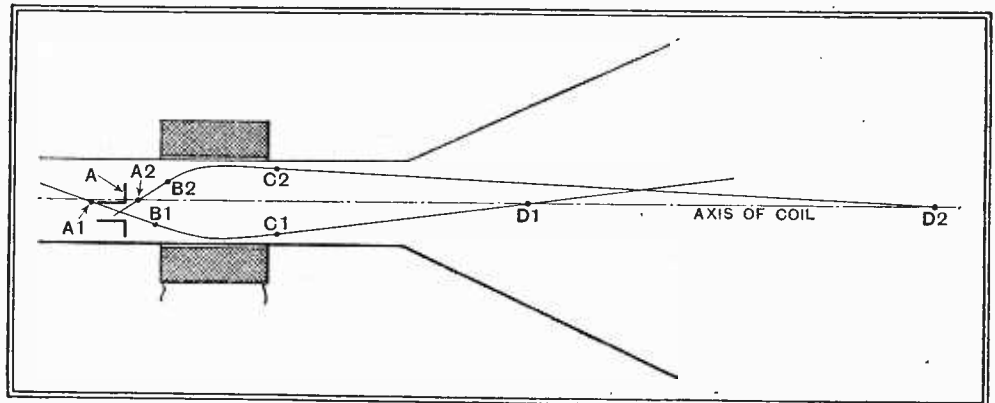

Fig. 8.—When the anode of the tube does not lie on the axis of the coil it is possible to secure neither a circular spot nor proper focusing.

although theoretically it should not give perfect focusing. As we shall see later, the actual diameter of the beam at various points is of considerable interest and importance.

There is a distortion which may occur in practice. If the anode of the tube does not lie on the axis of the coil then the spot on the screen is not circular and cannot be focused properly. Fig. 8 shows the reason for this.

An electron on path $AB_1C_1D_1$ focuses as though it had come from an anode A_1 , whilst one on path $AA_2B_2C_2D_2$ focuses as though it had come from an anode A_2 , i.e., the two electrons focus at different points, D_1, D_2 . The effect on the screen as the focusing current is varied is that the "spot" changes continuously from a small straight

line in one direction to a similar line in a perpendicular direction. This, of course, spoils definition in the picture.

Influence of Magnetic Deflection

This type of deflection is particularly suitable for use with magnetically focused tubes. It is, of course, effected by surrounding the neck of the tube in front of the focusing coil by a pair of coils carrying a saw-tooth current and arranged to have a uniform field across the section of the tube. This causes the linear deflection of the spot on the screen which is required for the "scanning" of the tube in either direction. In connection with this, the beam diameter is important. To take a practical instance, suppose the beam diameter is $\frac{1}{8}$ in. as it passes through the deflecting coils. Then, unless the field of the coils is uniform over the whole cross-sectional area of the beam, different parts of the beam will receive different deflections and the spot will be drawn out into a line. This is one reason why the coils must have a uniform field.

A serious defocusing occurs if the coils are definitely unsymmetrically positioned in such a way that their field has a component along the axis.

There are several other small effects of the deflecting fields which may show as astigmatism, or defocusing, but with suitable deflecting coils the results appear to be superior to those obtained with electrostatic deflection.

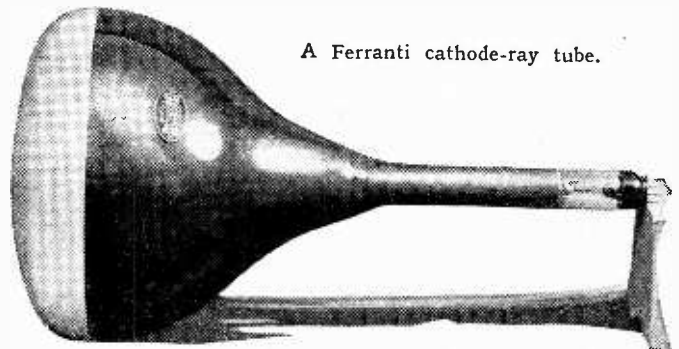

A Ferranti cathode-ray tube.

We have mentioned the beam diameter and intensity in one or two places. This is specially important because it is not easy to obtain a large beam intensity (or beam current as it is called) with a beam of very

Magnetic Focusing— narrow cross-section. This accounts for the relatively poor light intensity of some electrostatic tubes. In magnetic tubes no difficulty is experienced in focusing a beam of more than sufficient intensity

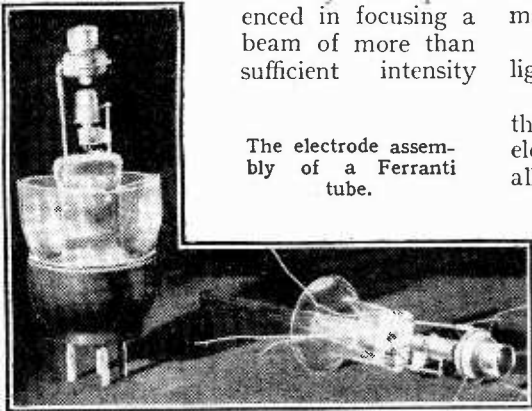

The electrode assembly of a Ferranti tube.

because this intensity can be obtained by using a comparatively wide-angled beam. But magnetic deflection is necessary for

such a beam, as its diameter is too large to allow of sensitive electrostatic deflection in the usual manner by a pair of plates within the tube neck.

To sum up, the chief advantages of magnetic focusing are:—

1. It is easy to combine very great light intensity with good focusing.

2. The electrode system is very simple; there is only one anode, whereas in the electrostatic tube there are three anodes, all at different high potentials. Furthermore, there is the difficulty of ensuring that all these anodes are in perfect alignment. The focusing coil, however, is adjustable for alignment as it is outside the tube.

And finally, the advantages of magnetic deflection are:—

Reduced cost of the scanning oscillators, simplified tube supplies, ability to scan a beam of high cross-sectional area, and external components making for easy adjustment.

RANDOM RADIATIONS

By "DIALLIST"

Playing Up

ONE of the most annoying things that can happen to the wireless set is the development of an intermittent fault. If you've a full equipment of testing instruments, some skill in tracking down defects, and the leisure and the energy to tackle the trouble just when it occurs it isn't so bad. What usually happens is that the owner of a set which sometimes goes all crackly, or puts up a display of "self-generated fading" every now and then, calls in a service man, who arrives ready and willing to do his best. The set is switched on. It functions perfectly. It continues to do so, no matter how the expert bangs it or shakes it or prods its innards. No test discloses anything wrong. The service man packs up and goes. Hardly has the door closed behind him when the set begins to play up. In one case that I came across a set was taken away for observations and kept for a week without doing anything that it shouldn't. But within a few hours of its being returned it was up to its old tricks again.

What Will the P.M.G. Say?

IT is expected that the Postmaster-General will have something interesting to say about anti-interference measures next Thursday, when he is down to reply to a Member's enquiry whether he has yet decided to introduce legislation compelling the "silencing" of electrical machinery that radiates interference. Something of the kind will have to be done eventually, and surely the best time to do it is now. Every day sees the installation of fresh domestic or commercial electrical appliances which are actual or potential radiators of the nasty noises that mar radio reception. Hence every day that is lost makes the problem a bigger one. One thing that most certainly should be done without any delay at all is to make it an

offence to manufacture, sell and install new appliances which are not fitted with effective suppressors. As regards existing machinery, the authorities now have ample data to work upon. They must know that in many localities interference is growing steadily worse and that, generally speaking, it can be cured by simple and comparatively inexpensive methods. But there won't be a complete cure until compulsion is introduced.

And About Licences

HEAPS of people are rather hazy about the scope of the wireless receiving licence. Everyone knows that if you have a set in your home you must have a licence; but what happens if you take a seaside or country bungalow for a holiday and hire a wireless set while you're in it? The P.M.G. has ruled that, though normally each tenant

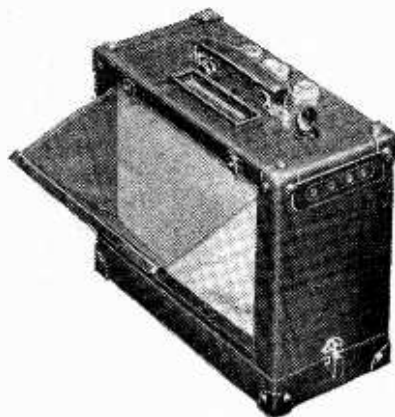

PICNIC PORTABLE: A LEIPZIG FAIR NOVELTY. The receiver is a 5-valve all-wave superheterodyne; a hinged plate in front of the loud speaker acts as a sound deflector.

of the said bungalow should take out a licence, a temporary tenant is covered by his home licence provided that he "dismantles" his own set before setting out for his holiday. Dismantling presumably means no more than disconnecting the set from mains (or batteries) and aerial and earthing the latter. Here are one or two other points that may be of interest. Your licence covers the use of a portable. Hence you can take one of these out with you in your car. But if you have a built-in car radio set a separate licence is necessary, the "address" of the receiving station being the number of the car. Your family and your servants can operate sets of their own in your home under your licence; but if you have a lodger his rooms are regarded as a separate establishment and he needs a licence to work a set in them.

Up She Went

MOST of us have been given to understand that it isn't wise to bring naked lights too near to accumulators owing to the hydrogen that they give off, but until the other day I'd never come across an instance of an accumulator going up in the proverbial blue flames. This one did its stuff pretty thoroughly. Here's what happened: Its bitumen top covering had become cracked and the owner thought he'd make a neat repair with Chatterton's compound. Thoughtlessly he removed it from the charging bench, and was proceeding to heat up a sticky mess over the flame of a spirit lamp when all of a sudden there was a report like the detonation of a six-inch shell. The glass case was blown to smithereens (there wasn't a fragment bigger than a broad bean) and he found himself the recipient of an acid shower-bath. Luckily help was at hand. Still more luckily his eyes weren't touched and he wasn't cut by the flying glass splinters. But it was a narrowish squeak. In future I shall treat gassing accumulators with considerable respect!

B.B.C. Hard Up?

SO the B.B.C. isn't too happy about the next ten years. It fears that receipts from its share of the licence fees and the profits on publications are approaching the saturation point, and it knows that a huge expenditure on new plant, renewals and developments of all kinds has to be faced. Television certainly is going to cost a mint of money unless the erection of the network of transmitters necessary to cover the country is to be held up—and held up it must not be. The only solution so far as television is concerned is probably to be found in a bigger Government grant from the 25 per cent. of the licence revenue which it now retains.

The time may be coming when our broadcasting organisation will have to be pretty radically overhauled. I'm not saying that the B.B.C. doesn't tackle a big job well. It does. But I'm not sure that it couldn't obtain equal efficiency for a considerably smaller expenditure.

Checking Piracy

Meanwhile it seems rather important to ensure that all those who make use of the broadcast programmes pay their whack, and that certainly is not now the case.

Just how many "pirates" there are no man can say, but to judge by the G.P.O.'s successful prosecutions of the unlicensed there must be a tidy few. Tracking them down by means of sleuths, detector vans and so forth is good enough up to a point, but

Random Radiations—

only up to a point. I've often wondered why the production of a receiving licence should not be made compulsory when sets, kits, or even accessories such as loud speakers, headphones, valves and batteries are purchased. This wouldn't entail any hardship on the man who already pays his way, but it would very soon put an end to radio piracy, particularly if dealers were made liable to a fine for supplying this or that without having seen the licence. This suggestion is only, after all, an adaptation of the firearms scheme, which works quite well. You can't buy a rifle or a revolver without producing a firearms permit. And every time you want a fresh supply of cartridges for them it must be handed to the dealer.

Other Ideas

It would probably be well worth while to rope in the pirates, for some people estimate their number at 500,000 or more, and their payments would make a useful addition to the funds available for broadcasting. Several ideas for dealing with them have been put forward, some of which undoubtedly have their points. One of these is that all receiving licences should run to the end of the year or to the end of a quarter, as motor car road fund licences now do. On the receiving set there would be a small licence holder like that which cars display. It would thus be obvious at a glance whether any set had or had not been licensed. Attractive though it is at first sight, there are difficulties about this scheme. Many people have more than one set. A few, like myself, have a constant stream of sets flowing in for test purposes and flowing out when tested. Still, these objections aren't insuperable. There's another aspect. I've always believed that the majority of pirates are those who simply can't afford to put down ten shillings all at once. They probably use little home-made crystal sets or the simplest of valve apparatus. Couldn't they be allowed, as motorists now are, to pay the licence fees quarterly?

They Don't Like Fiddling

WHAT a pleasure it is to turn from an "all-wave" set with only one short waverange to one which has two. The dial is so much easier to read and tuning becomes less of a feat of hair's-breadth juggling. I'm using just now one which goes from 15 to 39 metres on its shortest range and from 37.5 to 90 on the next. I'm sure that manufacturers would be well advised to give this season's models two short wavebands at the old price (or a little more, if need be) rather than stick to one band and bring the prices down. For the beginner at short-wave reception it must be very difficult with a single-range set to pull in anything but the most strongly received stations; with two clearly marked ranges on the dial he'd find both himself and the set far better performers. How often one finds that those who have bought "all-wave" receivers and are disappointed with them owe their lack of success to a natural inability to fiddle with the very fine adjustments that may be needed when a set covers from about 16 to 60 or 70 metres in one sweep!

Service Problems

FROM time to time I have criticised the doings of the bad radio service man; I've also had more than one good word to say about the man who really knows his job. The position is very complicated. As matters stand, there are not a few wireless

shops which offer so many months' free service with the sets that they sell, and try to cut costs by taking on service men at low wages. That's probably as good (or as bad!) an instance as you could find of false economy. There's an old saying which is to-day as true as ever it was: You get what you pay for. Offer a small wage, and you can't expect a man who is thoroughly efficient. Now, the inefficient service man probably costs his employer indirectly a good deal more than is "saved" directly on his wages. People who find that every breakdown means sending the set back to the makers soon lose faith in the man who should be their mentor and guide. That is why those who live in villages or small towns are apt to leave the local wireless dealer and to transfer their custom to the bigger shop in the bigger town.

Experts Wanted

Here's a true example of the kind of thing I have in mind: a set of well-known make had for some time been giving poorer and poorer results. The service man came in several times, but made no improvement. On his last visit he removed the set, kept it for a fortnight and returned it as bad as ever. It had to go to the makers before the trouble (faulty alignment of the IF circuits) could be diagnosed.

I believe that a capable and well-trained man could make a good living in many districts by setting up on his own as a curer of radio troubles. He might, perhaps, be best advised to begin in a small way by doing odd jobs in the evenings or in other spare time. Once he had established a bit of a reputation for good work and fair charges he should be able to make wireless servicing a whole-time occupation.

Skip Distance for Atmospherics?

SOME time ago I mentioned in these notes that more than once I had found very little atmospheric interference when a

thunderstorm was in progress quite close, and suggested tentatively that there might be a skip area for atmospherics. An Australian reader writes: "I have noticed the same thing here. The most striking instance was during a very violent thunderstorm accompanied by rain, hail, and wind of almost hurricane force—together a specimen of atmospheric disturbance of the first magnitude. As there was a broadcast item that I particularly wanted to hear I decided to leave the set on till atmospherics should make reception impossible. To my surprise, atmospheric interference was very mild, only a sharp crack from the loud speaker coinciding with each lightning flash, many of which were very close, the thunder occurring within one second." Subsequent observations have gone to show that far worse interference may be produced by a fairly distant storm than by one which is almost overhead.

Chain Listening

NOT long ago I was staying with some friends who are veritable chain listeners. The cigarette chain smoker uses each stub to light a fresh one, and is hardly conscious that he is smoking; the chain listener keeps his set switched on hour after hour, and often hasn't the least idea of what is coming from the loud speaker. When I pulled my friends' legs on the subject they indignantly denied that they did anything of the kind. A little later on I asked whether they could tell me what the broadcast talk that had just ended had been about. They were surprised when I informed them that it had been on a highly technical agricultural subject! I believe that chain listening is pretty common. Many people seem to like a slight background of noise—it doesn't matter whether it's speech or music—as an accompaniment to whatever they may be doing. I wonder what our great grandfathers would think of life in the modern home if they could see and hear it!

Portable Oscillograph

ONE of the most useful tools developed in recent years is the cathode-ray tube, especially when it has associated with it a linear time-base so that it forms a complete

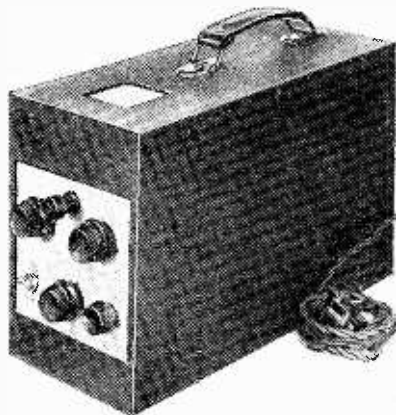

The viewing window in the oscillograph can clearly be seen in this illustration.

oscillograph. The apparatus under review contains a high-vacuum tube, mains equipment and time-base in a case which measures only 5½ in. by 7½ in. by 11¾ in.

The tube is viewed through an opening 1½ in. square in the top of the case, and the front panel carries the controls, of which there are five. One is for focusing and another for varying the intensity of the image; a third is the on-off switch, and the remaining two control the frequency of the time-base. The frequency is continuously variable by means of a resistance which is used in conjunction with a range-selector switch which varies the circuit capacity in steps.

The time-base is of the gas-filled triode type, and an amplifier is used so that the deflecting plates are fed in push-pull. The input voltage is fed to the other pair of plates, and a portion of it also to the time-base, so that synchronising is obtained.

The apparatus is extremely compact and easy to handle, and on test proved capable of a satisfactory performance. Focusing is easy to carry out and quite definite, and the sensitivity is adequate for most purposes. About 35 volts is needed for full deflection, so that a good picture is obtained with 5 volts or so input only.

The oscillograph is made by Furzehill Laboratories, Boreham Wood, and is priced at 14 gns.

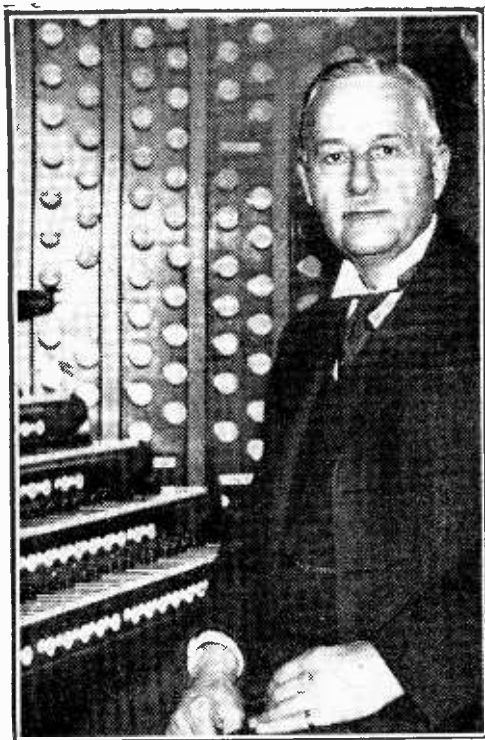

CORONATION ORGANIST. Sir Walter Alcock, who played the Abbey organ at the last two coronations and has been invited to play at that of King George VI, will give a recital in Colston Hall, Bristol, which will be heard by Regional listeners on Tuesday at 8.30.

gional listeners an account of the fights for the Amateur Boxing Association's Championships.

A VARIETY of sporting events comes into the current week's programmes. Certainly Mr. S. J. de Lotbinière, the Director of Outside Broadcasts, is exploring every avenue of sport in an endeavour to provide new material for O.B.s.

On Saturday three venues will be visited for National listeners. The first, at 2.55, will be the Worcestershire Hunt's Point-to-point meeting at Crowle, where the principal event, the race for Lady Dudley's Cup, will provide a running commentary. Immediately following this, at 3.20, H. M. Abrahams will describe for ten minutes the final stages in the A.A.A. Seven Mile Walk which will be in progress at the White City. Then at the close of this, at approximately 3.30, the switch will be put over to Belfast, where, at Ravenhill Park, the second half of the International Rigger match between Ireland and Wales will provide the third commentary.

On Monday and Tuesday, at 2.30 and 3 respectively, Tommy Woodroffe will be at the Queen's Club, West Kensington, to give National listeners a running commentary on the progress of the games in the Amateur Squash Racquets Singles Championship.

Then on Wednesday evening John Snagge and Tommy Woodroffe will be present at the Albert Hall to give Re-

SPRING SONG

ALTHOUGH of a different category to sporting events, an O.B. on Sunday further demonstrates the resourcefulness of Mr. de Lotbinière and his satellites. Headed, "The Approach of Spring," a fifteen-minute broadcast from a wood near Horley, Surrey, will, it is hoped, bring to Regional listeners at 5.15 the songs of the birds.

"IN TOWN TO-NIGHT"

ON Saturday, for the last time until Coronation Week, London's traffic will "stop" to bring to the microphone personalities who are in town to-night. It may be of interest to record that, during the 122 half-hour broadcasts, some 3,000 characters have come to the microphone. A. W. (Bill) Hanson will be busy in the coming weeks making arrangements for the Coronation Week's programmes, when "In Town To-night" will be broadcast each weekday evening except on Coronation Day. It is, of course, difficult to make final arrangements, in what is essentially a surprise item, until the last minute, but it is proposed that five continents will be represented by interesting and picturesque personalities visiting the metropolis.

Details of the week's Television programmes will be found on p. 337.

Listeners' Guide

Outstanding Broadcasts at Home and Abroad

NATIONAL HEALTH

THE nation-wide movement for improving the physique of adults and children should gain impetus from an important series of talks, "Towards National Health," which are to be broadcast during the next three months. Eminent authorities will discuss problems of food and fitness from two standpoints, nutrition and physical culture. The first speaker will be Lord Horder, Physician-in-Ordinary to H.M. the King, whose subject on Monday at 8 (Nat.) will be "All this talk about health."

"WHAT A WORD"

FEW subjects would seem more inherently suitable for discussion at the microphone than that of words. Since the development of broadcasting, the speech of the average man is affecting the language even more quickly than did Cax-

grammes have been tapped to provide entertainment for listeners. The artistes who will be heard include Frances Day and Irene Prador.

SUNDAY TALKS

THREE new series of talks commence in Sunday's National programme. At 4.0, Howard Marshall opens the series of investigative talks headed "What is the Church Doing?" by relating an interview he has had with the Rev. Leslie Weatherhead, Minister of the City Temple. An hour later the Rev. Canon H. Anson gives the first of the series, "Fifty Years of Religious Experience." Then, at 6.15, J. A. Spencer will talk about Gladstone in "I Knew a Man."

"MONDAY AT SEVEN"

A NEW style of entertainment cocktail with the above title comes into the National programme on Monday and each succeeding Monday at 7. Leslie Henson will be heard with Norah Howard in a series of sketches. Carroll Gibbons will be at the piano for ten minutes,

MORE ADVENTURES of Mr. Penny will be related by Richard Goolden during the series "Monday at Seven."



ton's invention, which brought the printed word. The first speaker in a new series of talks, "Words Fail Me," will be Professor A. Lloyd James, Chairman of the B.B.C.'s Spoken English Committee. He will be heard at 8.40 (Nat.) on Thursday.

HEARING TELEVISION

THE sound transmission of the television programmes will be enjoyed by Regional listeners on Tuesday at 9. This will be the first occasion on which the television pro-

and the Variety Orchestra will give a novelty interlude.

MUSIC

THE Russian tenor Alexander Smirnoff, who has not hitherto broadcast in this country, will be heard by National listeners on Saturday at 8.10. He will sing the famous arias from Tchaikowsky's "Queen of Spades" and "Eugen Oniegin," and will be joined by his wife in a duo from Massenet's "Manon" and the Fountain Scene from "Boris Godounov." Once a captain of Lancers in Tsarist Russia, he began his professional career as a singer after the Revolution.

or the Week



BARBARA BURNHAM, the talented B.B.C. producer, who this week handles the production of "The Cherry Orchard," a Russian play featuring Jeanne de Casalis, and "I Made you Possible" a modern play by Ivor Brown.

A programme of English part-songs sung by the Fleet Street Choir will be broadcast Regionally on Monday at 9. On the same day, at 8.20, Clifford Curzon, one of the best-known English pianists, who already has a great reputation abroad, will play the Brahms F Minor pianoforte sonata. Another English pianist and composer, Dora Bright, will be on the air on Thursday at 6.40 (Nat.), when she will give the first performance of her own Theme and Variations for pianoforte and orchestra, with Clarence Raybould conducting. Dora Bright was the first woman to receive the Lucas Medal for composition at the Royal Academy of Music.

OPERA

Home: Two relays from foreign opera houses grace the Regional programme this week. The first, to-night (Friday) at 8, when Act I of Kurt Atterberg's "Fanal" comes from the Royal Opera House, Stockholm. The second on Thursday, when Act II of Wagner's "Die Meistersinger" will be relayed from the Berlin State Opera House at 7.35.

Abroad: The week's opera programmes from abroad commence with de Falla's "La vida breve," the work which was the foundation of the composer's world fame. It will be heard from Brussels I at 8 to-night (Friday), relayed from the Théâtre Royal de la

Monnaie. Manuel de Falla is justly considered the foremost figure in the modern Spanish school. Königsberg's Friday opera transmission at 8.10 brings a new German work, "Licht," by Mirsch-Riccus.

The ultra-modern German opera, "Aennchen von Thaurau," given by Breslau at 7.10, is the outstanding opera programme for Saturday.

Sunday brings a gala performance of "Madame Butterfly" from the Théâtre de la Monnaie, relayed by Brussels I at 7. The Berlin opera programme for the same hour brings the work of a graceful and pleasing composer of the last century, "Tsar and Carpenter," by Lortzing. It was produced at the Gaiety Theatre, London, as "Peter the Shipwright" in 1871. Needless to say, it deals with the life of that amazing person Peter the Great, Tsar of Russia, who worked for a time as a common shipwright in Amsterdam and Deptford to amass knowledge for the good of his country.

FOR C.B.S.

A CONCERT of Danish folk-songs, arranged for relaying by the C.B.S. of America, will be heard in the Copenhagen-Kalundborg programme on Thursday at 7.45. This should give listeners an opportunity of hearing a representative programme of Danish folk music with English commentaries.

NORWEGIAN

FOUR leading lights of swing-music in Norway with Jules de Vries, the international saxophone player, will give a programme of swing music from 6.50 to 7.40 on Monday, from Oslo.

ANKER SKJOLDBORG and his band who will be heard in the Danish programme at 10.10 to-night (Friday) playing from The Prater, a popular Copenhagen restaurant.

HIGHLIGHTS OF THE WEEK

FRIDAY, APRIL 2nd.

Nat., 5.15, Yascha Krein and his gypsy orchestra. 8, The Air-do-Wells.

Reg., 6, B.B.C. Orchestra (E) and Leslie England (piano). 8, Act II of "Fanal," from the Royal Opera House, Stockholm. 9.20, Songs You Might Never have Heard—VI.

Abroad.

Radio-Paris, 8.45, "France in Song": gala programme with Maurice Chevalier and Jean Sorbier.

SATURDAY, APRIL 3rd.

Nat., 5.15, The B.B.C. Dance Orchestra. 8, Music Hall, including Vic Oliver, the Two Leslies and Flanagan and Allen.

Reg., 4, The Air-do-Wells. 9.20, Discussion: Wages and Conditions in Retail Trade.

Abroad.

Sottens, 7.30, Symphony Concert from the Salle de Conférences.

SUNDAY, APRIL 4th

Nat., 7, Victorian Melodies—13. 9.5, "The Cherry Orchard" (Tchekov).

Reg., 5.15, Leslie Jefferies and the Grand Hotel, Eastbourne, Orchestra. ¶Albert Sammons in the Sunday Orchestral Concert.

Abroad.

Frankfurt, 8, Paul Lincke's operetta music.

MONDAY, APRIL 5th.

Nat., 7, "Monday at Seven." 8, Talk: "Towards National Health." ¶"I Made You Possible" (Ivor Brown).

Monday, April 5th (*continued*)

Reg., 7.30, Mozart musical biography: Midland Orchestra. 9, The Fleet Street Choir.

Abroad.

Beromünster, 7.15, Tonhalle Orchestra of Zürich with Erna Sack (soprano).

TUESDAY, APRIL 6th.

Nat., 5.15, Frank Biffo's Brass Quintet. ¶Musical Comedy, "The Girl Behind the Counter." 9.40, Gaby Valle and the New London Trio.

Reg., 6, Reginald King and his orchestra. 8.30, Organ Recital: Sir Walter Alcock. 9, From the television programme.

Abroad.

Brussels II, 7, Die Fledermaus (Johann Strauss).

WEDNESDAY APRIL 7th.

Nat., 6.40, Music from the Movies. 8.15, Queen's Hall Symphony Concert.

Reg., 8.15, "Palace of Varieties." 9, Recital, Peter Dawson.

Abroad.

Leipzig, 8, "A Night on the Lido" —orchestra and soloists.

THURSDAY, APRIL 8th.

Nat., 7.40, The Fol-de-rols. 8.40, Talk: Professor A. Lloyd James, "Words Fail Me." ¶Orchestre Raymonde.

Reg., 6, Musical Comedy, "The Girl Behind the Counter." 7.35, "Die Meistersinger" from the Berlin State Opera House.

Abroad.

Brussels II, 7, Symphony Concert: orchestra, male voice choir and carillon.

Some of Bela Bartok's pianoforte works will be played by a relative, Ilonka Bartok Kopsland, from the Norwegian network at 8.25 on Thursday.

SPRING

THE annual spring concert by the famous Swedish Students' choir, Stockholms Studentsangerforbund, will be heard from the Swedish stations at 7.5 on Saturday. The concert, which is to be held in the Koncerthaus, Stockholm, will include a number of Swed-

ish songs which, according to my Scandinavian Correspondent, should not be missed.

HAMS

ALTHOUGH at a time when few readers will be able to listen-in, an O.B. in the Finnish programme on Thursday at 4.0 is noteworthy. Headed "Grasshoppers of the World," it will consist of microphone visits to Finnish short-wave amateur transmitters. This will be radiated by Helsinki.

THE AUDITOR.



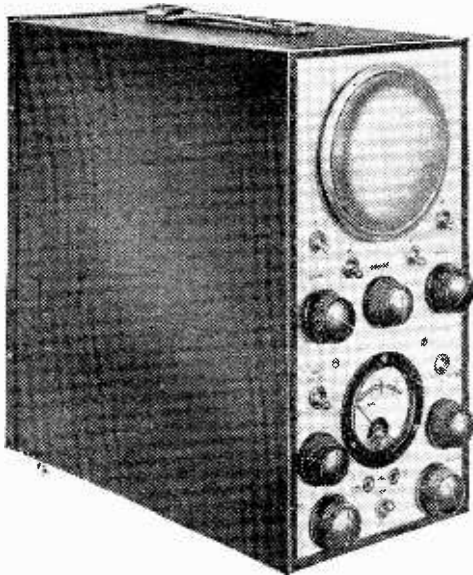

Fig. 1. The Standard Telephones cathode-ray oscillograph.

THE cathode-ray oscillograph is a comparatively new tool, but it is already as indispensable to a radio or communication laboratory as a voltmeter or a pair of headphones, and incomparably more powerful than either. When it is considered that an alternating current or voltage is characterised by four variables, viz., magnitude, frequency, wave-form and phase, and that while a meter will only deal with the first of these an oscillograph will deal with all of them at once, we wonder how our predecessors managed before the days of oscillographs. For a long time, of course, we have had the mechanical oscillograph, but it never became the popular and almost commonplace instrument that the cathode-ray oscillograph is becoming. This was due partly to the limitations of the older instrument, but even more, perhaps, to its weight and cost. Few laboratories could have more than one, and it was only used deliberately and for special investigations. Now that a laboratory may have half a dozen portable oscillographs, an engineer will use them with the same freedom as he uses a voltmeter.

An oscillograph may be used in two ways. As an oscilloscope it gives a pictorial view of phenomena, and helps an investigator to an insight into what is happening. As a measuring instrument it can be looked on as a kind of two-dimensional voltmeter or ammeter. Probably the former application is the more generally useful, for the reason that understanding a phenomena qualitatively generally comes before a quantitative study. Qualitative studies, however, are easily made quantitative by calibrating the deflections from an external source.

The photograph in Fig. 1 shows a suitable oscillograph manufactured by Standard Telephones and Cables, Ltd. It contains a $4\frac{1}{2}$ in. gas-focused tube, a linear time-base, and a single stage low-distortion amplifier, and all necessary mains supply apparatus.

This instrument will deal with frequencies from 30 c/s to about 500,000 c/s,

The Cathode-Ray

ITS APPLICATION AND USE AS AN INSTRUMENT FOR LABORATORY MEASUREMENT

and has a maximum sensitivity, when using the amplifier, of about 7 mm. per volt.

It is not possible to deal exhaustively with the applications of such an instrument. New applications, and adaptations of old ones, will occur constantly to the user. Indeed, almost any electrical phenomenon which can be represented in a two-dimensional graph can be drawn on the screen, i.e., wave forms, resonance curves, modulation envelopes, frequency characteristics, B-H curves, etc. A few of the more usual applications will be briefly touched on here.

ONE of the most noteworthy events of recent years has been the development of the cathode-ray oscillograph from an expensive and highly specialised piece of apparatus into a relatively cheap and easily handled laboratory tool. So flexible has the apparatus become that there are few operations in design and research which are not made easier by its assistance. A few of the more important applications are described in this article

One of the commonest uses is the examination of wave forms, using the linear time-base. Thus, if a modulated input is applied to a radio receiver, the audio wave form may be traced as it passes through the radio-frequency portion of the set (as a modulated envelope) and as a simple audio wave in the low-frequency part of the set.

Receiver Measurements

If the LF input to the modulator be connected to one pair of plates and the actual signal be applied to the other pair, a series of interesting pictures results. In the audio part of the set a straight line is produced if the signal and the input are in phase and an ellipse if they are out of phase, so that the changes in phase through the amplifier can readily be studied. In the RF portion the same connection produces a trapezium diagram from which the depth of modulation and its linearity may be read off at once as well as the phase changes of the envelope.

For many purposes it is useful to convert the linear time-base into a frequency base. Fig. 2 shows in principle how this may be done. A valve such as the AC/SP1 is bridged across the LC circuit of an oscillator. The valve is easily seen

to be equivalent to an inductance of RC/g henries where g is the mutual conductance of the valve, which can be varied by altering the suppressor potential. If the suppressor is supplied with voltage taken from the linear time-base it will be seen that to each position of the spot in its horizontal traverse of the screen, there will correspond a particular inductance of the AC/SP1 and a particular oscillating frequency. The circuit shown is suitable only for a fairly narrow frequency range, the Q of the valve circuit becoming bad if the range is pushed too far. However, by using the principles of a heterodyne oscillator, the range may be extended.

The commonest application of the frequency base is to trace a resonance curve, by applying the frequency base to the horizontal plates and the voltage across the tuned circuit to the vertical plates. A radio receiver may be lined up more accurately and quickly by this method than by any other, and the effects on the shape of the curve of any proposed modifications to the circuit can be seen instantly.

The frequency base can also be used for analysing distorted waves into their component harmonics. Suppose the LC circuit of Fig. 2 included in the triode portion of a frequency-changer valve to whose signal grid a distorted wave of fundamental frequency f_0 is applied, and suppose a resonant circuit is included in the plate circuit which selects a particular side-band frequency f_s . When the oscillator is generating a frequency

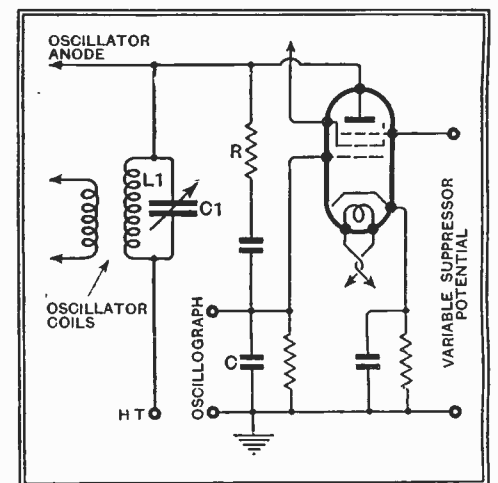

Fig. 2. A circuit is shown here which enables the frequency of an oscillator to be suitably varied for depicting resonance curves on a cathode-ray tube.

$f_s + f_0$, it will beat with the fundamental f_0 to produce side-bands of $f_s + f_0$ and f_s . The latter will be selected

Oscillograph

By S. HILL

Standard Telephones and Cables Ltd.

and applied to the cathode-ray oscillograph where it will draw a line proportional in length to the amplitude of the fundamental f_0 . At some different oscillator frequency, i.e., at some other definite part of the screen, a line will be drawn representing the magnitude of the second harmonic and similarly for other harmonics. A similar principle might be used to analyse a noise spectrum into its component frequencies or even to draw a complete frequency characteristic of an amplifier.

The linear time-base incorporated in the oscillograph forms the most generally useful means of viewing phenomena, but for some purposes an elliptical base is preferable. This can very easily be arranged if a sinusoidal voltage is divided into two

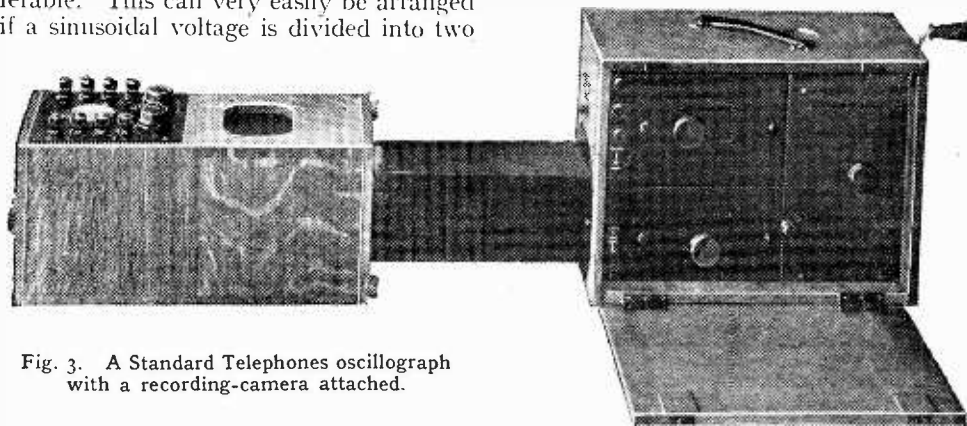

Fig. 3. A Standard Telephones oscillograph with a recording-camera attached.

quadrature components by means of a resistance and a condenser, and these two voltages applied to the two pairs of plates. A second frequency injected into the circuit feeding one of the plate-pairs produces a closed figure the pattern of which is a very accurate indication of the ratio of the two frequencies. An application of this principle is very useful for calibrating laboratory oscillators over a wide frequency range from one frequency standard.

The usefulness of an oscillograph is greatly extended by photography. Not only can permanent records be made of such phenomena as are discussed above, but switching and fusing surges which are too rapid to be studied as they appear on the screen can be recorded and measured. For such purposes a film camera such as the one illustrated in Fig. 3 can be used.

Special Oscillographs

The above applications need only a general purpose oscillograph such as that illustrated in Fig. 1. It is not possible, however, to make the instrument universal, and many special applications present themselves which require special oscillographs, or special auxiliaries. Some of the more usual of these applications are catered for by commercial instruments. Thus Standard Telephones and Cables

manufacture a transportable high-speed transient-recorder for photographically recording such phenomena as lightning surges which may last from three or four microseconds up to about 1,000 microseconds. Again, a triple unit is made for photographing three phenomena at once and a dual-wave unit for throwing two phenomena in succession on to one tube so quickly that the eye perceives them as if they were present together. The engineer, however, frequently has to build his own auxiliaries for his own special purposes. In building special oscillograph

circuits he often has to decide whether he will use a high-vacuum tube or a gas-focused tube. It is often supposed, because of the universal use of the former in television sets that the gas-focused tube is an older and obsolete form of the high-vacuum tube. Both forms, however, have their uses.

The Choice of Tube

In general, the high-vacuum tube has wider possibilities than the gas-focused tube, but more circuit elaboration is needed to realise these advantages. Where, for example, a linear time-base is used which limits the frequency range to about half a megacycle, the extended range of the hard tube is of no value, as a gas-focused tube will handle this range and offers, in addition, the advantages of lower voltage, greater sensitivity and a finer trace. The gas-focused tube has also the advantage that it can be applied without defocusing to unbalanced circuits, i.e., to circuits which have one "earthy" terminal. It is for reasons such as these that the gas-focused tube was used in the general purpose oscillograph described.

The applications dealt with above show how powerful a tool a cathode-ray oscillograph has become in a laboratory. Its high impedance, the direct appeal of its

pictorial information, and above all, its absence of inertia make it particularly adaptable to the study of wave phenomena, which is one of the principal occupations of communication engineers. The inventive effort which television has brought to bear in the cathode-ray tube will certainly continue to react on the tube as a laboratory instrument and will lead to a freer use and to further applications.

Television—A Guide for the Amateur.—By Sydney A. Moseley and Herbert McKay. 144 pages. 31 photographic plates and 50 other illustrations. Oxford University Press, Amen House, London, E.C.4. Price 5s.

ANYBODY who, picking up this book and glancing through the introduction and the first chapter or so, rejects it on the ground of being too elementary and "popular," is advised not to form his judgment in this way, but to go farther.

With Chapter III it plunges right into the most modern and highly technical devices, and, so far from shying at the particularly sticky patches such as electron optics and the supersonic light-relay, it deals with them in considerable detail.

It is unfortunate, therefore, that one comes across considerable inequalities both of clarity and accuracy. There is a brilliantly lucid explanation of the usually rather difficult phenomenon of polarisation of light, but the treatment of electron optics is confused almost beyond intelligibility by a serious error in Fig. 32. Explanations of the Iconoscope and the electron multiplier also are not everywhere too happy.

The error, which one has come to expect almost as a matter of course, of stating that a Kerr cell *rotates* the plane of polarisation of the light ray duly appears and is reiterated. The explanation of the working of time bases by means of a *diode* (the now accepted use of the pentode is not mentioned) is muddled and quite wrong.

The following are some typical extracts:—

"In broadcasting sound we are dealing with waves of comparatively low frequency; the maximum for sound is about 10,000 vibrations per second. In television we are dealing with frequencies ten thousand times as great."

"For television we have to use rapid waves, almost as short and rapid as light waves." (To be precise, ten to twenty million times as long.)

"Light waves are so short that modulations due to them would be lost on the long waves used in ordinary wireless transmission."

A reader who already knows something of the subject may be conscious of much repetition, but, of course, the novice may grasp the second time what he missed the first. The only danger is that he may fail to realise that the two matters are identical.

An excellent feature of the book is that no single system is given undue prominence and that mechanical systems receive their rightful place. Not only are recent devices of the Scopphony system—including the Jeffree relay—explained, but also the Mihaly-Traub system; and large-screen pictures are given a whole chapter. It is therefore obviously up to date.

The photographic illustrations demand a special word of praise, being numerous and well-reproduced, and (as is so seldom the case) relevant to the text. M. G. S.

Electrostatic Focusing

THE PRINCIPLES OF ELECTRON OPTICS AS APPLIED TO THE CATHODE-RAY TUBE

By G. PARR

(Radio Division, The Edison Swan Co.)

THE electron beam in a cathode-ray tube must be focused on the screen if satisfactory results are to be secured. There are several ways of doing this, and one widely adopted is to pass the beam through suitable electrostatic fields which affect it in a manner analogous to the way in which light is modified by lenses

OF the three methods of focusing the electron beam — magnetic fields, traces of gas in the bulb, and electrostatic fields, the latter is the most recent discovery, and yet within a few years it has acquired an extensive bibliography and the dignity of a separate classification. Under the title of "Electron Optics."

Fig. 1.—In this view of the electrode assembly of an Ediswan tube the anodes and plates for electrostatic focusing and deflection are clearly shown.

It is curious that in view of the original theory that light consisted of corpuscles emitted from a luminous body the analogy between electrons (which are most definitely particles emitted from a luminous body!) and light rays should not have been apparent at an earlier date. The first complete investigation, however, appears to be that of Knoll and Ruska*, who constructed electrical equivalents of glass lenses in 1932 and succeeded in focusing a stream of electrons to a point, the whole system imitating almost exactly the action of a convex lens.

Further development showed that it was not necessary to imitate the glass lens in physical construction and that the beam could be focused with equally good results by passing it through a series of perforated discs or cylinders to which a suitable potential was applied. From this has arisen the complicated-looking structure of the modern electrostatically-focused cathode-ray tube (Fig. 1) in which the focusing electrodes are mounted rigidly one above the other on the glass pinch, extra care being taken in the insulation of each anode. The terms anode and grid have been adopted from

standard valve practice to denote the equivalent electrodes in the cathode-ray tube, and in the electrostatic tube there are usually three anodes numbered outwards from the cathode.

How the Beam is Refracted.

To understand the focusing action of a positive potential applied to an electrode in the path of the beam it is convenient to consider the simple case of Fig. 2, in which an electron is travelling at an angle a to the axis and enters an electrostatic field at PP' .

The initial velocity of the electron as it enters the field can be resolved into the two components parallel with the axis and at right angles to the axis, $v \cos a$ and $v \sin a$, where v is the velocity. As soon as the electron enters the field its axial velocity is increased since this is proportional to the accelerating potential (or more correctly, to the square root of the potential). The component $v \cos a$ will thus be increased while the vertical component $v \sin a$ remains as before. As a result the path of the electron on leaving the field will be at a lesser angle a' , the amount of refraction of the electron path being governed by the applied potential. The optical equivalent of this change of

direction of the electron is given in Fig. 2 (b), giving us the familiar equation for the refractive index of the medium through which the ray passes as:

$$\mu = \frac{\sin a}{\sin a'}$$

If the initial velocity of the electron beam is due to a potential V_0 , and the potential of the field through which it passes is V , we can calculate the electron path "index of refraction" which works out to

$$\mu = \sqrt{1 + \frac{V}{V_0}}$$

It will be seen that by giving suitable high values to V the index of refraction

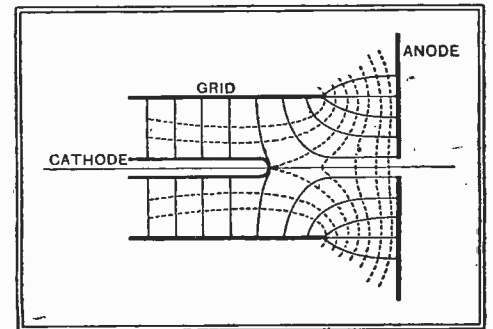

Fig. 3.—This drawing shows the field between the cathode, grid, and first anode.

can be made much higher than is the case in ordinary optics, and, in fact, lens systems with a refractive index of 100 have been constructed.

The Practical Base

The simple theory outlined above is not sufficient to cover the practical focusing of electron beams for a number of reasons, the principal ones being that the field due to a charged disc or cylinder does not have a sharply defined boundary line but is graded off. The refraction of the beam therefore takes place in several stages. Secondly, the beam is of definite cross-section instead of a point source as we have assumed. This gives rise to complications where the electron is travelling from some point not on the axis of the lens system. Finally, there is the mutual electron repulsion which exists at all points on the path of the beam which limits the smallness of the focused spot.

As might be expected, the electron beam suffers from similar focusing defects to those met in optics, such as spherical aberration and astigmatism. To minimise spherical aberration the electron optical

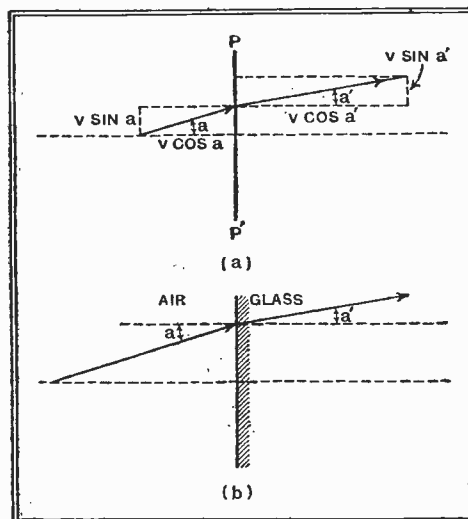

Fig. 2.—The analogy between electrostatic focusing and the refraction of light is clearly brought out in these diagrams.

* See Bibliography at end.

Electrostatic Focusing—

lens system must be limited in curvature in a similar manner to glass lenses, and the divergence of the entering beam must not be too great. It is preferable, therefore, to refract the beam gradually by more than one potential surface rather than attempt to do it by a single large diameter lens. For this reason the majority of large television tubes employ three anodes in succession for the focusing of the beam, although with smaller tubes two are usually adequate.

The Lens System

A further advantage in the use of three anodes will be seen on examining the action of the Wehnelt cylinder, the electrode surrounding the cathode. This is an essential part in all tubes, whether magnetically or electrostatically focused, and in addition to controlling the electron current it acts as a pre-concentrator on the lines of the condenser lens of an arc lamp. The diagram of Fig. 3 shows the field between the grid (as the cylinder is usually called) and the cathode. The lines of equipotential, i.e., lines joining points at the same potential with respect to the cathode, are shown dotted, intersecting the field lines. The electron can be considered as tending to travel normal to the equipotential lines, and the beam emerging from the cathode will be constricted to pass through the hole in the anode as a compact jet. The field between the grid and the first anode, a disc or cylinder placed immediately above the grid, thus constitutes the first lens of the electron-optical system. A second lens is formed by a field between the first anode and the second, placed above it on the axis of the tube. In this simple lens system the grid not only acts as a modulator of the source of the beam but also as a lens electrode. It follows that extremes of modulation caused by large potential changes on the grid will be accompanied

the main lens system to the regions between the first and second and second and third anodes respectively, leaving the grid with the main function of controlling the beam intensity.

The diagram of Fig. 4 shows a complete electron-lens system (that of the R.C.A. tube type 903) and the path of the beam is shown by the outlined section. The actual potentials are marked against the equipotential lines. Note that the first anode here is called "grid No. 2," and has a fixed potential of 100 v. Corresponding British tubes have a first anode potential of 250-400 v., the second anode being at 900-1,200, and the third at 4,000-6,000. True focusing is accomplished by variation of the second anode potential, the first and third anodes being fixed. For a given first anode potential the intensity and sharpness of the spot are increased by increasing the potential of the final anode, and it is seldom desirable to reduce this below 3,500 volts for clear pictures.

The Potential Gradient

The potential of the first anode has an important bearing on the life of the tube, as, no matter how carefully exhausted, there are a certain number of positive ions in the region of the cathode. These will travel towards the cathode at a velocity proportional to the first anode potential, and since their kinetic energy is proportional to the square of the potential their impact will tend to destroy the emissive surface. Reduction in the first anode potential by reducing their velocity will thus considerably prolong the life of the cathode, and it is false economy to attempt to brighten the spot by increasing this anode voltage.

In designing electron-optical lens systems ingenious use is made of a large-scale model of the electrodes, which is immersed in a tank containing a conducting liquid. The appropriate potentials are then ap-

B.T.H. Co., at the recent Physical Society's Exhibition, in which the paths of the electrons could be plotted directly on to a chart by means of a pantograph. The importance of such an instrument to the designer of cathode-ray tubes will be appreciated.

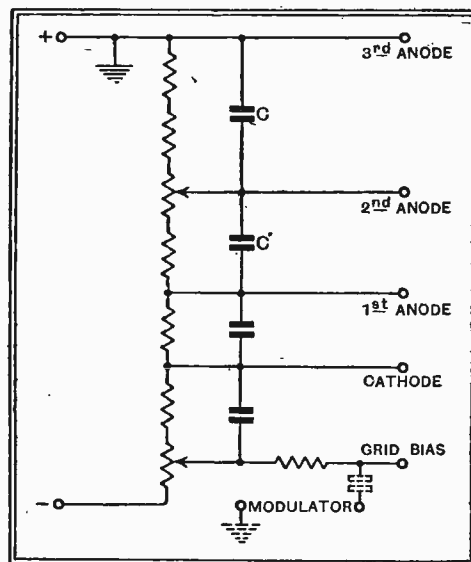

Fig. 5.—The voltage-divider used in providing the necessary potentials for electrostatic focusing is shown here.

Fig. 5 shows a typical circuit for the potential supply of a three-anode high-vacuum tube. The current taken by the tube, i.e., the beam current, can be regarded as negligible, and the calculation of the resistances is a simple application of Ohm's law, due regard being paid to the degree of variation in potential required. The by-pass condensers shown are not all essential and C and C' can be omitted in most cases.

BIBLIOGRAPHY

- Knoll and Ruska: "Annalen der Phys.," Vol. 12, p. 583, 1932.
- Johannson and Scherzer: "Zeit. f. Phys.," 80, p. 464, 1933.
- Taylor, Headrick and Orth: "Electronics," Dec., 1933.
- Maloff and Epstein: "Proc. I.R.E.," Vol. 22, p. 1386, 1934.
- McArthur: "Electronics," June, 1932, p. 192.

The Radio Industry

REFERRING to a recently published letter from a reader, in which it was urged that radio dealers should provide a valve-testing service at a small fixed charge, the makers of Radiometers equipment tell us that they have always encouraged their dealers to conduct such a service. Practical assistance is given by supplying report forms, etc.

The annual report of McMichael Radio, Ltd., discloses that the past year's activities have been extremely successful. A profit of £29,731 is announced.

To avoid confusion with a firm of similar name, the S.P. Fidelity Sound System has changed its title to The Acoustical Manufacturing Company. Larger works have been obtained at 33, Sutton Road, London, N.W.10, where all communications should now be addressed.

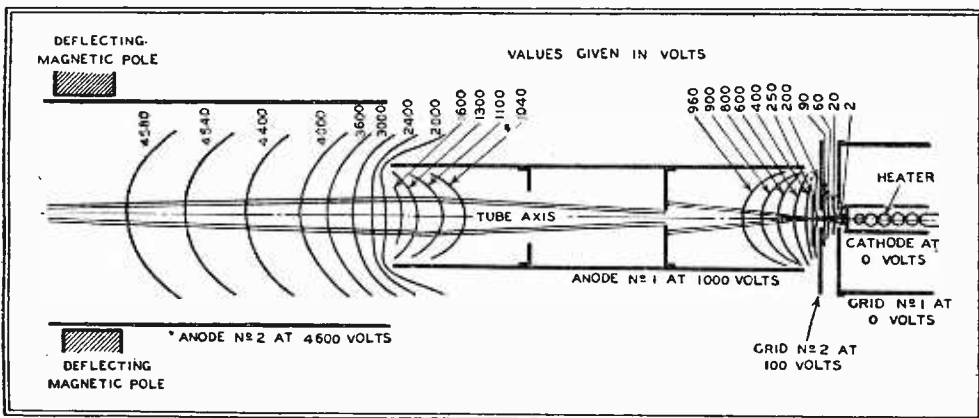

Fig. 4.—The potential gradient along a cathode-ray tube is well illustrated by this diagram, which also shows the path of the electron beam.

by loss of focus as the field between grid and first anode is altered. For this reason two-anode tubes are not desirable for television reproduction in which the focus of the spot must be constant, irrespective of its intensity. The addition of a further anode to the system, besides improving the gradual focusing of the beam, shifts

plied to the electrodes, and the fall of potential due to the passage of current between them is measured by a probe electrode connected to a bridge. By this means the equipotential lines can be plotted and the approximate path of the electrons predicted. An improved form of tank was shown by Dr. Gabor, of the

New Apparatus Reviewed

Recent Products of the Manufacturers

GNOME BATTERY CHARGER

THIS unit undoubtedly derives its description from the very compact form in which it has been found possible to compress it. Though it consists of a double-wound mains transformer and a metal rectifier, the overall size is only $3\frac{1}{2}$ in. \times $2\frac{3}{4}$ in. \times $2\frac{3}{4}$ in. Its particular function is that of charging two-volt radio batteries from the AC mains, and it is rated to give a charging rate of 0.5 amp.

Tests were made on a 220-volt 50 c/s AC supply, and the charging rate, with a partially run-down accumulator, was 0.45 amp.



Gnome AC charger for two-volt radio batteries

A very slight hum was audible during operation, but the temperature rise was not above the normal for apparatus of this kind, as the case is well ventilated.

Finished in bright blue enamel this useful device costs 13s. 6d.

The makers are Gordon Equipments, Ltd., 25, Milton Street, London, E.C.2.

VELODYNE SUPREME MICROPHONE EQUIPMENT

SHAFTESBURY MICROPHONES, LTD., 24, Aldersgate Street, London, E.C.1, have introduced a new and improved model of the Vex velocity ribbon microphone, which is now described as the Shaftesbury Velodyne Supreme Microphone.

A considerably larger output than is usually obtainable from ribbon microphones is provided by this model, as in place of a single ribbon, which is customarily used, the Velodyne type is fitted with several ribbons arranged in series but with a common magnet system.

The output is such that a good three-stage amplifier suffices to give adequate volume for most purposes.

The equipment sent in for test comprised a table model Velodyne microphone and an AC/DC three-stage amplifier designed for use with it. This amplifier embodies two top-grid triode valves feeding a pair of Tungram PP36 valves. Included in the full equipment are two loud speakers, but as these did not accompany our apparatus the test was made with a loud speaker of known characteristics and of about 15 ohms impedance.

The equipment is so arranged that it can be assembled in a few minutes, since the several parts are interconnected by cables with plugs.

Though only aural tests were made, these sufficed to show that the quality of reproduction is exceptionally good; speech is clear and entirely free from sibilant accentuation, while the sound of keys shaken and similar tests for fidelity left no doubt in the mind of the listener as to the nature of the items employed.

Shaftesbury new Velodyne ribbon microphone and universal AC/DC amplifier.

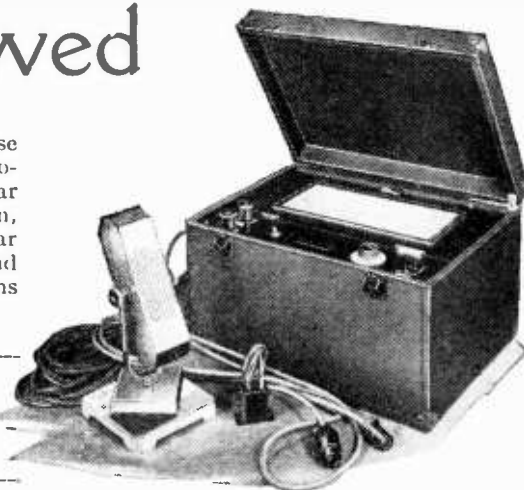

Characteristic sounds are faithfully reproduced, which is possibly one of the best tests for fidelity in any sound-amplifying equipment.

Despite the fact that the amplifier gives a high gain, the hum level is very low, and so also is the background of the microphone.

A final test, using the output from an AF beat oscillator, failed to reveal any resonances either in the microphone or in the amplifier from zero to 10,000 c/s.

Judging from the tests carried out, it can be said that the microphone is free from resonance and has an ostensibly flat characteristic up to at least 9,000 c/s, while even above this upper limit an appreciable output is evident.

The new Velodyne Supreme Microphone finished in chromium plate costs £12 12s., including a transformer, while the complete equipment, comprising the microphone mounted in a floor stand, a 10-watt universal amplifier, twin loud speakers, and all necessary cables, is available at £50.

GOODMAN'S ELLIPTICAL LOUD SPEAKER

SEVERAL advantages are offered by the elliptical cone over the normal circular diaphragm. Of these the wider angle of diffusion of high frequencies is, perhaps, the most important, but the shape is also very convenient to the designer when the layout of the cabinet has to be considered. The type is becoming increasingly popular with set manufacturers, and with the introduc-

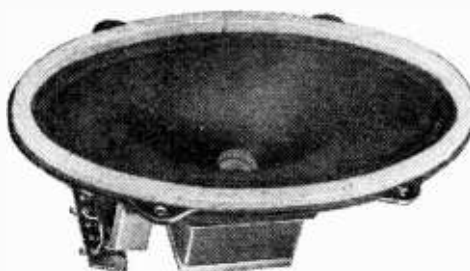

Goodman's elliptical cone PM loud speaker.

tion of the Goodman's elliptical cone loud speaker the amateur constructor can also avail himself of its advantages.

A rigid cast aluminium frame supports the cone, which measures $10\frac{3}{4}$ in. on the major axis and $5\frac{1}{2}$ in. on the minor axis. The sides of the cone are curved with a very steep rise on the minor axis which gives good efficiency at high frequencies.

An axial response curve was not taken in this instance, but the performance as judged by ear showed that the balance of output between high and low frequencies remained substantially constant through an angle of at least 150 degrees in the horizontal plane.

The sensitivity is good, and the useful frequency range is from 60 to 9,000 cycles with a well-controlled fundamental resonance at about 75 cycles and a slight increase of output round about 2,500-3,000 cycles. Sounds rich in high frequencies are faithfully reproduced, and there is a remarkably good bass output for so small a diaphragm. The suspension is free, and the unit accepts powers up to at least 4 watts quite happily.

There are two models, one for mains excitation with the usual range of field resistances at 38s., and a PM type at 46s.; both types include a multi-ratio transformer.

Electrical Inventions, by Professor A. M. Low, pp. 124, 8 plates, published by Thomas Nelson and Sons, Ltd., 35-36, Paternoster Row, London, E.C.4. Price 2s. 6d.

MANY people who are constantly making use of electricity for various domestic purposes, such as lighting and heating, must often wonder "how it works." Text-books, even of the elementary kind, are usually far too technical and go into too much detail. This book is, however, the very thing for such people. Practically all uses of electricity are dealt with, including, of course, wireless and television.

Einführung in die physikalischen Grundlagen der Rundfunktechnik. By Dr. Otto Franke, Vienna. Pp. 272+viii. 167 figs. Julius Springer, Schottengasse, 4, Vienna. RM.9.60.

THIS introduction to the physical foundations of broadcasting is based on courses of lectures given to physicists and electrical engineers. It is a very thorough mathematical course, suitable for university students specialising in this subject. It is divided into four chapters under the headings: Electric oscillations, valves, electric waves, and radio telegraphy and telephony. It does not attempt to describe practical constructions, but is confined to the underlying principles. It uses the methods of vector analysis, and the treatment reminds one of Abraham and Föppl's "Einführung in die Maxwell'sche Theorie." The diagrams are good, and it is a book that one can confidently recommend. G. W. O. H.

Cathode-Ray Tube Characteristics

Operating Data on Tubes for Television and Laboratory Equipment

OF recent years the use of cathode-ray tubes has been rapidly increasing in most fields of electrical research, and there are now few laboratories which do not include among their equipment some form of CR apparatus. For the visual examination of wave forms, the automatic plotting of resonance curves, and for phase measurements, the cathode-ray tube has few rivals; it is now even finding its way into service equipment.

Although it has long been known and used, it is only since the introduction of a high-definition television service that it has become widely known among those who are not professionally engaged in the wireless industry. Television has, in fact, been directly responsible for much development in CR tubes, especially in the production of large tubes.

Basically the tube consists of an electron-emitting cathode, which may be directly or indirectly heated, an accelerating electrode, and a fluorescent screen on the end of the tube. A high positive potential is applied to the accelerator, or anode as it is now more often called, and this accelerates the speed of the electrons so that they strike the screen with sufficient velocity to make it fluoresce.

In practice, a shield, grid, or modulating electrode is fitted around the cathode, and maintained at a suitable negative potential. There are also in many tubes several anodes, in addition to deflecting plates.

With the three electrodes mentioned a stream of electrons from the cathode to the screen can be obtained, but for satisfactory results more than this is necessary. The electrons cannot be allowed to travel at random through the tube, but must be constrained into the form of a beam of small cross-section and focused on the screen so that a very small, bright spot is obtained.

The focusing of an electron beam is exactly analogous to the focusing of a beam of light, and the means adopted to this end is consequently often called an electron lens. Such lenses can reproduce in their own sphere most of the characteristics, and can have most of the defects, of optical lenses.

There are three distinct methods of focusing—by gas, magnetically, and electrostatically. With the last two systems the tubes are evacuated as much as possible and are known as high-vacuum types, but with the first a suitable amount of an inert gas is introduced during manufacture. Gas-focused tubes generally require lower voltages than high-vacuum types and are consequently widely used in oscillographs; the focus is critically dependent on the grid voltage, and this must be capable of variation by the operator. Partly because of this factor and partly

because there is a definite upper limit to writing speed, or operating frequency, such tubes are unsuitable for television purposes and also for high-frequency wave form examination.

The majority of modern tubes are of the high-vacuum type, and of these the majority are focused electrostatically. Such tubes have two or three accelerating anodes, and focusing is carried out by varying the potential of anode 1 in a two-anode tube, or anode 2 in a three-anode tube. The brilliancy can be varied by changing the negative grid voltage, and quite a large variation is possible without any effect upon the sharpness of focus. The grid can thus be used to

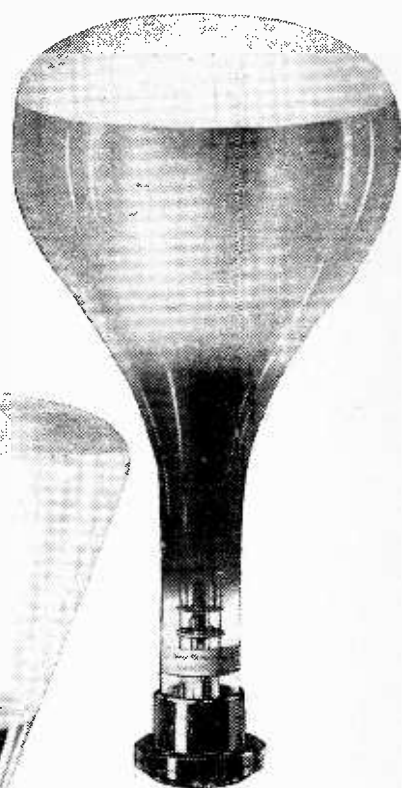

The Ediswan 12H (left) and the Cossor 3272 (above) television cathode-ray tubes are shown here.

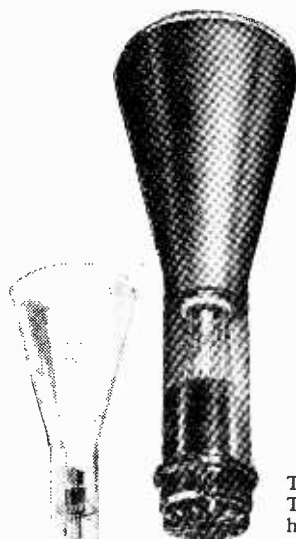
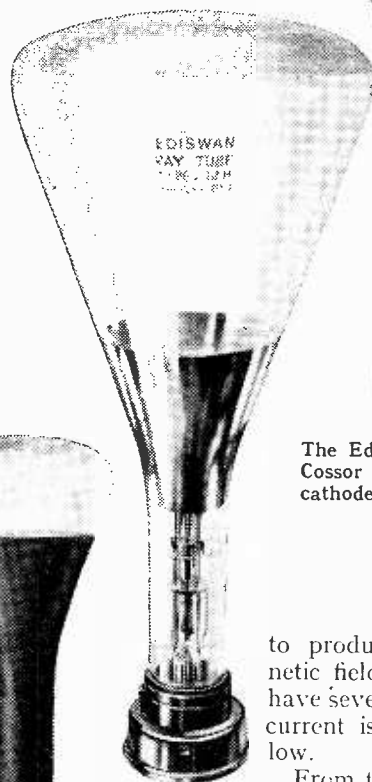

The Standard Telephones 4063A high-vacuum tube is shown above and the 4050A gas-focused tube on the extreme left. The centre tube is the Mullard high-vacuum type E42-G6.

introduce a modulating voltage, and in television the vision signal is applied to it.

Magnetically focused tubes are not common at the present time, but several examples are to be found among the types suitable for television. Such tubes have only one anode, and focusing is accomplished by varying the strength of an electromagnet which consists of a coil around the neck of the tube. In practice, a variable resistance in series with the coil enables the current through it to be varied so that the proper focus is obtained. Several hundred ampere-turns are needed

to produce the necessary magnetic field, so that the coil must have several thousand turns if the current is to be kept reasonably low.

From the point of view of the user, electrostatic focusing is undoubtedly the simpler, for he has to do nothing but apply suitable voltages to the electrodes, whereas with magnetic focusing he has to provide an electromagnet correctly positioned round the tube. From the point of view of tube construction, however, the latter system is the simpler, and better focusing is sometimes claimed. With either arrangement it is important that the electron beam should pass through the centre of the lens, otherwise astigmatism will be produced. With electrostatic focusing this is controlled by the manufacturer, and depends upon the accuracy of alignment of the electrodes, but with magnetic focusing it is dependent upon the position of the external coil and is readily controllable by the user.

In practically all applications of the cathode-ray tube it is necessary to deflect the beam in two directions at right angles to one another. Again, this may be done electrostatically or electromagnetically. The former is practically universal in tubes intended for general purpose use, but among television types the two methods are nearly equally divided. A tube which is intended for double electrostatic deflection includes two pairs of deflecting plates at right angles; one pair is usually called

(Continued on page 334)

CATHODE-RAY TUBE CHARACTERISTICS

		BAIRD	COSSOR									EDISWAN			
Type		15 WMI	3232	3234	3236	3237	3272	3273††	3274	3276¶	3277‡‡	5 H	7 H	10 H	12H
Heater	Volts	1.7	0.6*	0.6*	0.6*	0.6*	0.6*	0.6*	0.6*	0.6*	0.6*	2.0	2.0	2.0	2.0
	Amps.	2.4	1.25	1.25	1.25	1.25	1.2/1.4	1.2/1.4	1.2/1.4	1.2/1.4	1.2/1.4	1.5	1.5	1.5	1.5
Normal Operating Volts	Anode 3	—	—	—	—	—	4,000	6,000	4,000	3,000	3,000	—	2,500	4,000	4,000
	Anode 2	—	—	—	—	—	700	1,000	700	500	500	2,500	800	1,200	1,200
	Anode 1	6,500	1,500	750	1,500	750	250	250	250	250	250	800	400	400	400
	Grid Bias	-110	-150	-75	-150	-75	-250	-250	-250	-250	-250	-200	-200	-100/200	-100/250
	Modulation†	70	—	—	—	—	60	60	60	60	60	—	—	20	20
Maximum Anode Volts‡		—	3,000	1,500	3,000	1,500	5,000	10,000	4,000	3,000	3,000	3,500	3,500	6,000	6,000
Amp.-turns for Magnetic focusing		¶¶	—	—	—	—	—	—	—	—	—	—	—	—	—
Type of Tube		HV	G	G	G	G	HV	HV	HV	HV	HV	HV	HV	HV	HV
Deflection Sensitivity	X-plates (mm. per volt)	—	370/V.	—	370/V.**	350/V.**	750/V.	750/V.	580/V.	340/V.	340/V.	450/V.	700/V.	800/V.	950/V.
	Y-plates (mm. per volt)	—	375/V.	350/V.**	375/V.**	350/V.**	820/V.	—	650/V.	400/V.	400/V.	450/V.	700/V.	800/V.	950/V.
	Magnetic (mm. per amp.-turn)	2.0	—	—	—	—	—	—	—	—	—	—	—	—	—
Capacities (μF.)	X ₁ - X ₂	—	1.5	—	1.5	1.5	1.0	0.5	1.0	1.0	1.0	—	—	4.0	4.0
	X ₁ or X ₂ - E	—	5.0	—	5.0	5.0	11.0	0.7	11.0	11.0	11.0	—	—	15.0	15.0
	Y ₁ - Y ₂	—	1.5	1.5	1.5	1.5	1.0	—	1.0	1.0	1.0	—	—	4.0	4.0
	Y ₁ or Y ₂ - E	—	5.0	5.0	5.0	5.0	11.0	—	11.0	11.0	11.0	—	—	15.0	15.0
	G - E	2.0	9.0	9.0	9.0	9.0	10.0	4.5	10.0	10.0	10.0	—	—	15.0	15.0
Dimensions (cm.)	Diam. of Screen	38.0	12.4	11.2	12.4	11.2	30.5	12.4	25.6	15.2	5.2	10.5	15.5	23.0	29.0
	Max. Diam.	—	13.5	11.4	13.5	11.4	34.2	13.5	28.0	16.0	5.2	12.5	17.5	25.0	31.2
	Max. Length	83.0	40.9	34.5	40.9	34.5	65.5	41.7	55.5	46.7	46.7	45.0	51.0	56.0	66.0
Screen Colour		White	Blue	Blue	Blue	Blue	White	Blue	White	White	Blue	White, Blue, Green	White, Blue, Green	White	White
Base		A	B	D	E	F	H	C	H	H	G	I	J	K	K
Price		—	£7 10s.	£4 15s.	£7 10s.	£5 10s.	£15 15s.	£12 12s.	£12 12s.	£8 8s.	£8 8s.	£8 8s.	£10 10s.	£12	£15 15s.

* Directly-heated cathode. † Peak-to-peak volts between black and defocusing. ‡ Maximum voltage for A1, A2, or A3 in 1, 2, or 3-anode tubes HV, High-vacuum tube. G, Gas-focused tube. ¶¶ Mag

CATHODE-RAY TUBE BASE CONNECTIONS

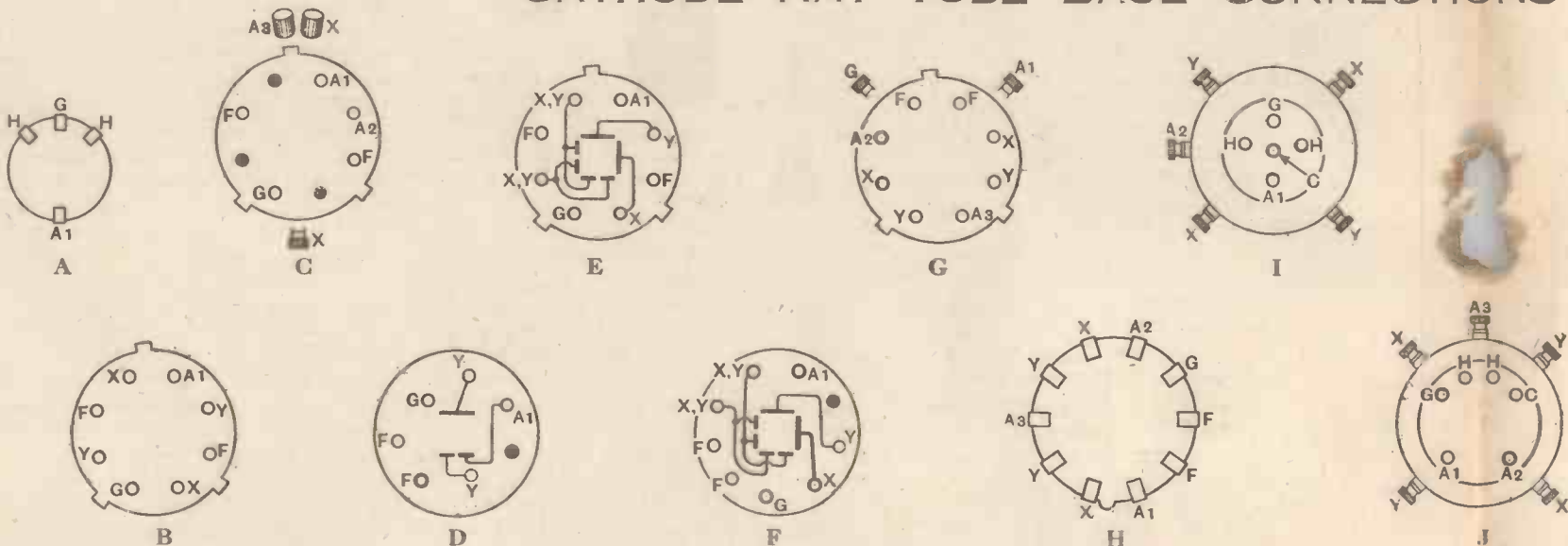

CHARACTERISTICS

WORKING DATA ON TYPES FOR TELEVISION AND LABORATORY EQUIPMENT

FERRANTI			H.M.V. and MARCONI		MULLARD								STANDARD TELEPHONES & CABLES		
T10	T12	T15	9"	12"	E40-G3	4002/4002A	4001/4001A	E42-G6 E42-B6	E46-G10 E46-B10	E46-12	EM46-12	E46-15	4050AG, 4050AB, 4050AD	4050BG, 4050BB	4063AW 4063AB
2.0 1.5	2.0 1.5	2.0 1.5	4.0 1.3	4.0 1.3	4.0 1.0	4.0 1.0	4.0 1.0	4.0 1.0	4.0 1.0	4.0 1.0	4.0 1.0	4.0 1.0	0.75* 0.85/1.0	0.75* 0.85/1.0	2.0 2.0
—	—	—	3,000 1,000	3,000 1,000	—	—	—	—	4,000 800	4,000 800	4,000 800	4,000 800	—	—	5,000 1,200
4,000 -50 30	4,000 -50 30	4,000 -50 30	300 -24 8	300 -24 8	500 140 -0/25	1,000 200 -0/45	2,000 400 -0/35	2,000 400 -0/35	800 250 -0/60	800 250 -0/60	800 250 -0/60	800 250 -0/60	—	—	—
5,000	5,000	5,000	6,000	6,000	800	1,000	2,000	2,000	6,000	6,000	6,000	6,000	750	750	5,000
¶¶	¶¶	200/300	—	—	—	—	—	—	—	—	—	—	—	—	—
HV	HV	HV	HV	HV	HV	HV	HV	HV	HV	HV	HV	HV	G	G	HV
—	—	—	—	—	150/V. 120/V.	440/V. 360/V.	640/V. 520/V.	640/V. 520/V.	550/V. 400/V.	550/V. 400/V.	1,500/V. —	550/V. 400/V.	275/V. 275/V.	275/V. 275/V.	650/V. 650/V.
§§	§§	2.54	§§	§§	—	—	—	—	—	—	—	—	—	—	—
—	—	—	—	—	3.7	2.0	3.0	7.0	5.0	5.0	—	5.0	0.75	0.75	1.5
—	—	—	—	—	—	—	—	—	—	—	—	—	6.5	6.5	12.0
—	—	—	—	—	2.9	2.0	2.0	6.0	4.0	4.0	—	4.0	0.75	0.75	1.2
—	—	—	—	—	—	—	—	—	—	—	—	—	6.5	6.5	10.0
—	—	—	—	—	6.7	7.0	10.0	12.0	15.0	15.0	—	15.0	—	—	15.0
22.8 25.4 61.0	27.9 30.5 61.0	35.6 38.1 71.0	21.6 22.8 57.0	28.0 30.5 70.0	7.0 7.5 16.5	9.5 9.8 35.0	16.0 16.7 45.0	16.0 16.7 45.0	25.0 27.0 55.0	30.0 32.0 66.0	—	38.0 40.0 68.0	10.0 11.5 33.0	16.5 18.0 46.0	14.0 15.6 53.5
White	White	White	White	White	Green	Green, Blue	Green, Blue	Green, Blue	Green, Blue	White	—	White	Green, Blue, Delay	Green, Blue,	White, Blue
S	S	S	L	L	M	N	O	P	Q	Q	Q	Q	R	R	K
—	—	—	£11 11s.	£15 15s.	£4 15s.	£6 15s.	£8 8s.	£8 8s.	£12 12s.	£15 15s.	—	£21	£5 5s.	£6 10s.	£8 10s.

s respectively. ** Split-plates. †† Transmitting tube. ‡‡ Recording tube. ¶ Monitoring tube. § Shield focusing voltage. §§ Magnetic deflection.

Abbreviations: A1=1st Anode; A2=2nd Anode; A3=3rd Anode; C=Cathode; F=Filament; G=Grid; H=Heater; X=X-Plates; Y=Y-Plates.

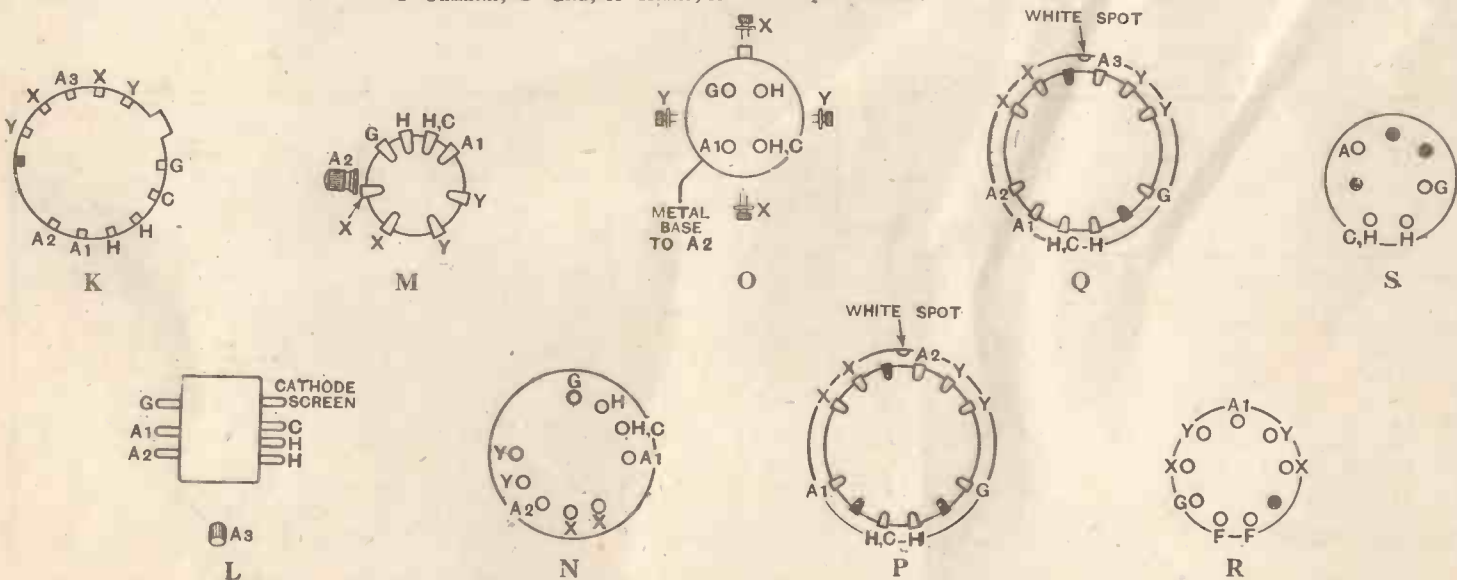

Cathode-Ray Tube Characteristics—

(Concluded from page 331)

the X-plates and the other the Y-plates.

The displacement of the spot on the screen measured in millimetres for one volt applied between the deflecting plates is called the deflection sensitivity. The sensitivity is inversely proportional to the voltage applied to the outermost anode (the second or third) so that in the tables it is expressed as, say, 600/V mms. per volt, where V is the anode voltage. If the tube is worked at 3,000 volts the sensitivity is 600/3,000=0.2 mm. per volt. With a large tube a deflection of 25 cms. may be needed and the voltage required is 250/0.2=1,250 volts. Were 6,000 volts to be applied to the anode, the sensitivity would be halved.

With magnetic deflection there are no plates in the tube and deflection is obtained by passing suitable currents through coils mounted alongside the neck of the tube. The beam is deflected parallel to the plane of the coil and it is usual to mount two coils with their planes vertical, one on each side of the neck, for the vertical deflection, while two more coils with their planes horizontal provide the horizontal deflection.

The sensitivity to magnetic deflection is less readily expressed than the sensitivity to electrostatic deflection, for it depends on the design of the external coils. As a guide, however, an approximate figure for ampere-turns is given in the tables.

In some cases, a combination of electrostatic and electromagnetic deflection is adopted. The tube then contains only one pair of deflecting plates and only one pair of external coils is necessary. For television, electromagnetic deflection is then invariably used for the frame scanning.

When a tube is required for television purposes the size of the screen is important, for as in most cases the size of the spot cannot be reduced below a certain limit, the screen must be large enough to accommodate the full number of lines without overlapping. In general, a screen of about 20 cms. diameter is the minimum for present-day television. This does not apply to transmitting tubes, however, which are generally operated with higher

voltages and so have a smaller spot size.

The dimensions of the rectangular picture which can be accommodated on a screen of given diameter are readily calculated. If we denote the picture height and width by H and W respectively, the picture ratio W/H by r, and the screen diameter by D, it is a matter of simple geometry to show that $H = D / \sqrt{1 + r^2}$ and $W = D / \sqrt{1 + 1/r^2}$. For the present transmissions the picture ratio $r = 5/4 = 1.25$ and with one of the large tubes the screen diameter may be 30 cms., so that the picture size works out at 18.7 cm. x 23.4 cm. (7.4in. x 9.25in.). In practice a somewhat larger picture can be accommodated, for the corners are often allowed to overlap the edge of the screen.

Screen Colours

The screen colour is a matter of considerable importance and the best colour depends upon the use to which the tube will be put. Television tubes invariably have a white screen which gives a black and white picture. In general, however, the white is not pure but has a marked bluish tinge so that a plain raster appears in very pale blue. This is by no means noticeable in actual picture reception, however, and the pictures really do appear black and white. Tubes intended for oscillograph use generally have either a blue or a green screen and certain types of the former are especially suited for photographic work.

The base connections of cathode-ray tubes are by no means standardised as yet. Some attempt at standardisation has been made with the newer tubes, but even then it is not complete.

The reference letters in the columns for base connections thus refer to the drawings of tube bases which appear below the tables.

Turning now to gas-filled triodes, the data given refers chiefly to operating conditions in time-bases. The maximum peak anode voltage rating places the upper limit to which the time-base condenser must be charged, while the column headed "Gas Voltage Drop" gives the minimum voltage to which the condenser can be discharged. The difference between these two voltages is the theoretical maximum peak-to-peak voltage of saw-tooth waveform obtainable. In practice, one should be content with an appreciably lower voltage.

The current through the valve is at its greatest in normal circumstances at the instant of discharge of the condenser. The condenser should consequently not be allowed to charge to such a high voltage that the discharge current exceeds the maximum rating.

The "Grid Control Ratio" is similar to the amplification factor of a hard valve. Briefly, if an increase of V volts in anode potential will cause the valve to strike, then a change of grid voltage in a positive direction of V/μ volts will have the same effect where μ is the grid control ratio.

The column headed "Maximum Operating Frequency" refers exclusively to time-base use, and for television purposes it is necessary to use a type suitable for operating at 10,000 c/s or more for the line-scanning circuit. For the frame time-base, however, the operating frequency is only 50 c/s and a greater latitude of choice is permissible.

In the operation of CR tubes it is, of course, necessary to guard against stray fields, especially from mains transformers, since these can cause serious deformation of the raster. To guard against this effect the tube is often enclosed in a metal screen which also serves to protect it against damage. For the same reason it is advisable to cover the screen with a sheet of plate glass. It must be remembered that the external air pressure on a large tube amounts to several tons and it is wise to guard against the danger of implosion.

GAS-FILLED TRIODES

Base Connections

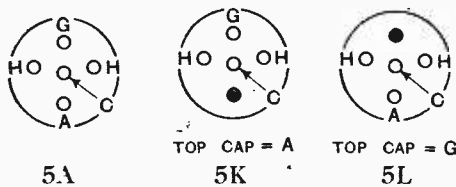

Type	Heater		Max. Anode Volts (Peak)	Max. Anode Current (mA. Peak)	Grid Control Ratio	Gas Voltage Drop	Gas	Max. Operating Frequency (c/s)	Base	Price
	Volts	Amps								
Cossor. GDT4	4.0	1.5	500	500	25-30	15	Neon	15,000	5 K	50/-
Marconi and Osram.										
GT1	4.0	1.3	1,000	1,000	20-25	12-18	Mercury	—	5 A	40/-
GT1A	4.0	1.3	300	600	20	15	Argon	—	5 A	60/-
Mazda.										
T11	4.0	1.2	700	300	20	15	Mercury	5,000	5 K	35/-
T21	4.0	1.2	200	300	20	17	Argon	15,000	5 K	60/-
T31	4.0	1.5	400	300	20	45	Helium	15,000	5 K	35/-
Mullard. GT4H	4.0	1.3	750	1,000	42.5	42	Helium	10,000	5 L	30/-
Standard Telephones & Cables. 4039A	4.0	1.0	500	200	30-50	10-20	Mercury	10,000	5 A	40/-

On The Short Waves

TWO B.B.C. engineers, E. J. Alway and C. G. Philips, pointed out in 1934 for the first time that the effect of visible sunspot was apparently greatly to increase the ionisation levels of the F, or Appleton, layer without materially increasing the levels of the E, or Kennelly-Heaviside, layer. This result was deduced from many observations made on short-wave stations transmitting on frequencies ranging from some 30 to 40 Mc/s (10-75 metres) and from information based on the performance of the Empire station at Daventry.

It was not possible at the time, however, to support this contention with definite measurements of E and F layer ionisation levels, but recently it is interesting to record that Prof. Appleton is credited with saying that during this year the ionisation level of the F layer has increased some 300 per cent. above its sunspot minimum value, whereas the percentage increase in the case of the E layer has been very much lower.

By the way, how many readers listened to Prof. Appleton's very interesting talk on "Sunspots and Radio" in the National programme on Sunday, March 21st?

Sunspot activity remained fairly high during the first week of the period under review, that is, from March 11th, declining to a minimum on Monday, March 22nd, only suddenly to jump into activity again on Tuesday, March 23rd, evidently the beginning of a new 27-day cycle.

The sunspots visible during the end of February reappeared again in March, but in a rather attenuated form, most of the activity being in the form of flocculi or the debris of the active spots.

To review conditions, however, we find that U/SW signals were quite good in the evening of Thursday, March 11th, a new police transmitter on 31.6 Mc/s, W2XIJ, being heard at R9+ at about 7.30 p.m. At this time, too, W9XAZ, on 26.4 Mc/s, was exceptionally good, equal, if not superior, to W3XAL and W2XAD at times, although not consistently so.

The quality of W9XAZ is really good, except that speech at times shows the typically boomy quality associated with ribbon (velocity) microphones not operated under ideal conditions.

A little later, at 7.50 p.m., a terrific heterodyne was noticed in the 11 Mc/s band, which was traced to DJO and JZJ both working on 11.80 Mc/s.

NOTES FROM A LISTENER'S LOG

At 8 p.m. DJO ceased working point-to-point with New York, and after this JZJ was a very good signal with a programme of native Japanese music; W2XAD was really excellent about this time, too.

Conditions were again good on Friday, but reception was poor on 28 Mc/s.

Although some signals were audible on the ultra-high frequencies on Saturday, March 13th, signals were much poorer later in the evening.

Conditions were similar on Sunday, when the two best 28 Mc/s signals were probably W4FT and W9BRZ; W2XE was also strong on 21.52 Mc/s, but apparently over-modulating.

Fair results were obtained from W3XAL on 17.78 Mc/s at 7.15 p.m., but W2XAD was very good, so also was Lisbon CSW on 11.04 Mc/s.

Conditions were moderately good on Monday, March 15th, and better still on Tuesday.

An interesting signal in the 28 Mc/s amateur band at 8 p.m. on Wednesday was intercepted from a portable transmitter W3BSY working in the 4th District, and conditions in this band, although good at 8 p.m., failed shortly afterwards; W9XAZ was poor by comparison with the amateurs.

Excellent results were once more obtained from W2XAD who is now working on an extended schedule to 11 p.m.

Conditions continued to remain good throughout the period under review, W2XAD being the best signal and generally of local station quality.

An interesting newcomer during the past fortnight was the German "Communist Party's" station on 10.07 Mc/s, which was particularly a strong signal on March 17th at 9.24 p.m.

Variable signals have been experienced from the remaining U.S. stations, though W1XK on 9.57 Mc/s and W8XK on 15.21 Mc/s have been good at times.

During the coming weeks we shall probably see the last of the bursts of 28 Mc/s activity before their return in the autumn, but it will be instructive to see this year whether the greatly increased sunspot activity will outweigh the fall in ionisation of the F layer due to its summertime expansion with the rising temperature.
ETHACOMBER.



SILENCING THE RECEIVER—This device, which serves as a stand for the domestic telephone, is wired to the receiver in such a way that the loud speaker is silenced by removing the instrument; a call can then be made or answered without disturbance.



MCCARTHY

Important! The prices at which McCarthy Chassis are advertised include Marconi Royalties. "Wireless World" readers should, for their own protection, make sure before purchasing any receiver that the quoted price includes the Royalty payment.

MCCARTHY ALL-WAVE SIX

with radio frequency stage

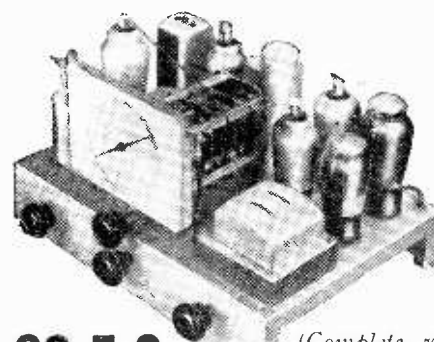

£8.5.0

(Complete with B.V.A. Valves.)

"De luxe" 6 valve receiver with 8 valve performance (specially recommended for tropical and foreign reception conditions). Built on special cadmium-plated 16 gauge steel chassis. Varley iron-cored I.F. coils. 14/2-wound tuning coils. 3 wave-ranges—16.5-2,000 metres. Illuminated "Airplane" dial with principal station names. Micro-vernier 2-speed drive. Circuit comprises: Pre-selector radio frequency amplifier (operative on all wavebands), triode-hexode frequency changer, double band-pass coupled I.F. amplifier, double diode detector. D.A.V.C. applied to 3 preceding valves. L.F. amplifier and pentode output. Variable tone control and volume control operate on radio and gramophone.

BATTERY ALL-WAVE SIX

£7

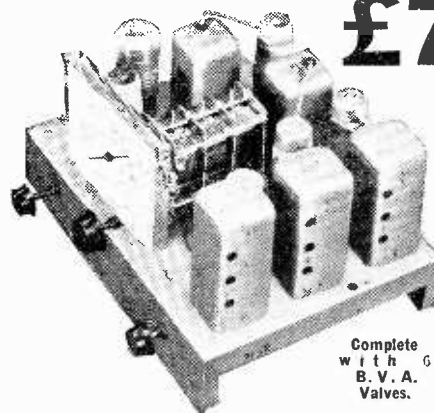

Complete with G B.V.A. Valves.

The only receiver of its type now on the British market. Results on all 3 wavebands equal to mains operation. Latest technical developments incorporated in circuit. Latest types valves, transformers, tuning coils, switches, etc. Specification in brief: radio frequency amplifier, first detector with separate triode oscillator, I.F. amplifier, double diode detector, L.F. amplifier, low consumption pentode output. D.A.V.C. volume control and tone control both operative on gramophone. Illuminated dial with station names. Wave-ranges: 16-52, 200-550, 900-2,000 metres.

All McCarthy receivers supplied complete with valves, knobs, pilot lamps, leads, mains cable and plug. 12 months' guarantee.

Deferred terms on application, or through London Radio Supply Co., 11, Oat Lane, E.C.2.

Cash with order on 7 days' approval. Also write for illustrated catalogue of complete range of all McCarthy receivers.

MCCARTHY RADIO LTD.
44a, Westbourne Grove, London, W.2

Telephone: Bayswater 3201/2.

Fluorescent Screens—DIFFERENT TYPES AND THEIR APPLICATIONS

DURING the past 30 years fluorescent screens have been made for use in connection with X-ray tubes. They are used in X-ray photographic practice for two purposes. The screens are placed between the subject and the photographic plate so that the plate is affected not only by the X-rays themselves but also by the visible luminescence of the screen. When a fluorescent screen is used in this way it is known as an intensifier. The other method of using the screen is to place it between an observer and the subject to render the X-ray shadow of the subject visible to the human eye.

When the cathode-ray oscillograph was brought to a form in which it could conveniently be used for measuring purposes by J. B. Johnson in 1925, the fluorescent screen was of Willemite. Willemite, which is zinc silicate, gives a green luminescence of relatively low efficiency, but it has the property of emitting light under the impact of low-speed electrons (300 to 500 volts). It should be noted, in passing, that the velocity of electrons is proportional to the square root of the accelerating potential.

Johnson's development of the hot-cathode, low-voltage cathode-ray tube led to an increase in the number of uses to which the instrument could be put, and therefore led to a great increase in the number of people who were familiar with its peculiarities. As a result of this, the development of the tube and of fluorescent screen materials proceeded rapidly.

Fluorescent screens consist generally of fine crystals having a diameter of 0.1 mm. or less, which are spread on the large end of the cathode-ray tube and held in position by means of an adhesive. There are now available some 30 different materials and mixtures having various properties and colours.

When electrons strike a fluorescent material some of the electrons forming the atoms of which the material is composed are ejected from the orbits in which they move into other orbits having a higher energy level. When these electrons return to their usual orbits they return to a lower energy level with a resultant loss of energy. The law of the conservation of energy tells us that energy cannot be lost, but that it may be changed from one form to another, and, in the case under discussion, some of the energy lost by the electrons is changed into luminous energy. For this reason,

the point of impact of the electrons on the fluorescent screen becomes visible to the eye.

Although the time required to eject an electron from its orbit and for it to return again is extremely short, it is, nevertheless, not zero, and, in certain cases, the time required for the process is of great importance. Furthermore, certain fluorescent materials having complicated atomic or crystal structures behave in a more complicated manner than that already described.

It is also of interest to note that the luminescence rises and decays in an exponential manner, and may therefore be expressed in the form of a time constant. In the case of materials having complicated atomic structures there may be a number of time constants involved, and

the luminous energy may not be all of the same colour. Levy and West¹ have discovered that the longer time constant components of the luminescence may be suppressed by the addition of minute quantities of nickel to the fluorescent material. For many purposes the long

time-constant components of illumination (known as afterglow) are a distinct disadvantage, since they tend to blur the image obtained. There are, however, certain instances in which the long time-constant component is of great value, e.g., in cases where the rate of travel of the cathode-ray spot is either so fast that the approximately instantaneous response cannot be seen, or so slow that persistence of vision is unable to aid the eye to see the image as a whole. A method of measuring these time constants has already been described, and will

¹ "Fluorescent Screens for Cathode-Ray Tubes for Television and Other Purposes," Leonard Levy, M.A., D.Sc., and Donald W. West, Journal I.E.E., Vol. 79, No. 475, July, 1936.

Contributed by the Cossor Research Laboratory

not further be discussed in this article.² Fluorescent screens can be made to emit light of practically all colours, some of which are extremely actinic, and are consequently in general use for photography. Other screens give a white light, which is of great value for television reception. The peculiar qualities of several screen materials are discussed later.

The list, which is given below, of fluorescent materials in general use for cathode-ray tube screens will be of interest.

It will be noted that the zinc sulphide and zinc-cadmium sulphide screens are of extreme interest, since the colour may be varied by the processes adopted for their manufacture. Moreover, they are extremely brilliant, and their brilliancy rises rapidly with voltage. (See Fig. 1.) This fact is of particular interest, since some other substances exhibit brilliancy saturation at relatively low voltages, so that they are of very little value for television reception. For certain low-voltage oscillographic work, however, these substances are quite satisfactory.

The Screen Materials

Calcium tungstate screens are very actinic, and are particularly suitable for photographic recording of oscillograms.

Zinc phosphate screens are often used for the examination and photography of high-speed transients, such as atmospherics. The presence of the relatively long afterglow enables the oscillogram of the transient to be photographed after it has ceased.³

Screens consisting of zinc sulphide combined with copper have a very important application, that of cardiography⁴ (the

² "The Transient Aspect of Wide-band Amplifiers," O. S. Puckle, *The Wireless Engineer*, No. 140, Vol. 12, May, 1935

³ "Cathode-Ray Photography of Random Electrical Transients," F. W. Chapman, *Nature*, Vol. 131, page 620, April 29th, 1933.

⁴ "A New Electrocardiograph Employing the Cathode-Ray Oscillograph as the Recording Mechanism," Proc. Roy. Soc. Medicine 1934, Vol. 27, page 1541.

ALTHOUGH primarily a chemical problem, the subject of fluorescent screens is of extreme interest to electrical engineers not only for television reception but for measurement purposes in connection with most branches of industry. For this reason, engineers, no matter whether they belong to the electrical, mechanical, or civil branches of the profession, cannot afford to ignore the subject.

Materials.	Colour.	Remarks.
Willemite	Green	Afterglow time approx. 1 millisecond.
Calcium Tungstate	Blue	Very actinic. Afterglow time constant less than 5 microseconds.
Cadmium Tungstate... ..	Pale Blue	Rather inefficient due to low luminosity.
Zinc Phosphate	Red	Afterglow (Red) time constant approx. 0.25 second.
Zinc Sulphide with Copper	Blue	Afterglow (Green) time constant approx. 30 seconds.
Zinc Sulphide	Various	With or without afterglow. Very brilliant.
Zinc-Cadmium Sulphide	Various	With or without afterglow. Very brilliant.

Fluorescent Screens—

examination and recording of heart-beats). Cathode-ray electrocardiographs are being increasingly used by hospitals and doctors. This is an instance where the rate of traverse of the cathode-ray spot is very slow, about an inch a second, and it is only the presence of a very long afterglow component which makes it possible for the observer to examine the complete trace.

Zinc sulphide screens can be made

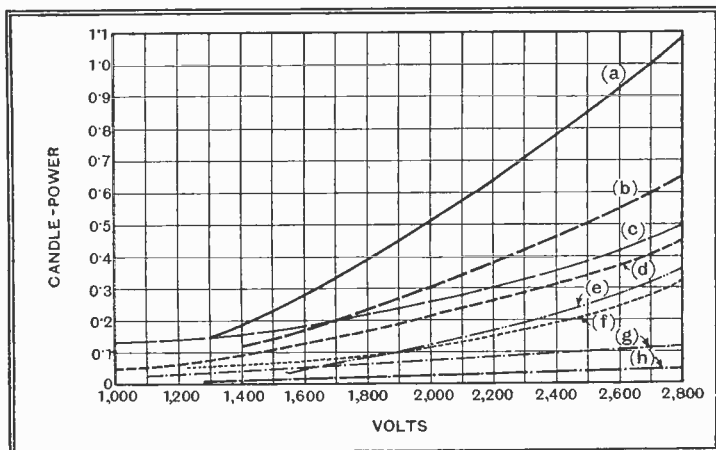

Fig. 1.—Curves showing the variation in brilliancy of the screen with changes in the applied voltage for a constant current of 150 μA. (a) zinc sulphide and zinc-cadmium sulphide; (b) and (c) zinc sulphide; (d) and (e) zinc-cadmium sulphide; (f) Willemite; (g) cadmium tungstate; (h) zinc phosphate.

in almost any colour, and the afterglow is controllable. An excellent zinc sulphide screen has been developed which gives a brilliant black and white image for television reception.

It is of interest to note that, although the light obtainable from a television cathode-ray tube is more than sufficient to

enable one to read a newspaper, the actual amount of light is only about 5 per cent. of the input energy to the tube.

The photographic recording speeds (expressed at the fluorescent screen) obtain-

able with various screen materials and with a lens aperture $f/1.0$ using a high photographic reduction ratio are given in the table below. The figures refer to high vacuum tubes.

When different values of photographic reduction and/or aperture are used, the above figures should be divided by the following expression:—

$$N^2 \left(1 + \frac{1}{M}\right)^2$$

where $N = f$ number

$M =$ linear reduction ratio of object to image.

The theory of operation of fluorescent

screens is not yet fully understood, and it is probable that further advances in manufacturing technique will be made as the mechanism concerned becomes more clearly appreciated.

Material.	Emulsion.	Recording Speed.
Calcium Tungstate	Iford Golden Iso-Zenith, Selo Ortho B or Iford Oscillograph Paper F.P.I.	10 Km. per second at 3,000 Volts.
" "	" "	40 Km. per second at 6,000 Volts.
Zinc Phosphate ...	Hyper-sensitive Panchromatic.	2.5 Km. per second at 1,500 Volts.

Television Programmes

Transmission times are from 3-4 and 9-10 daily.

Vision 45 Mc/s. Sound 41.5 Mc/s.

FRIDAY, APRIL 2nd.

3, Stanelli. 3.10, Fashion Forecast: a dress parade. 3.25, British Movietonews. 3.35, Theatre Parade: scenes from a play now running in the West End. 9, Repetition of 3.10 programme. 9.15, Constable's Centenary: an illustrated talk on Constable and his works. 9.30, Gaumont-British News. 9.40, After Supper: a revue of evening entertainments.

SATURDAY, APRIL 3rd.

3, At the Nets: cricket broadcast from the Alexandra Palace Indoor Cricket Club. 3.30, Gaumont-British News. 3.40, The Oxford University Opera Players present "Venus and Adonis." 9, Repetition of 3.40 programme. 9.35, British Movietonews. 9.45, Cabaret.

MONDAY, APRIL 5th.

3, Demonstration of Ju-Jitsu. 3.15, Sea stories: Commander A. B. Campbell. 3.25,

Gaumont-British News. 3.40, Cosmopolitan Café. 9, Repetition of 3 programme. 9.15, Beatrice Harrison (cello). 9.25, British-Movietonews. 9.35, Cosmopolitan Café.

TUESDAY, APRIL 6th.

3, "The Proposal": a jest in one-act. 3.20, Filming a Devil Dance; talk by T. A. Glover, an explorer who has "shot" film in almost every part of Africa. 3.45, Starlight. 9, Cabaret including Frances Day, Irene Prador and Lydia Sokolova. 9.20, Gaumont-British News. 9.30, Repetition of 3.20 programme. 9.45, Music Makers.

WEDNESDAY, APRIL 7th.

3, Light entertainment. 3.20, Gaumont-British News. 3.30, Forty-third Picture Page. 9, Forty-fourth Picture Page. 9.30, British Movietonews. 9.40, A dress demonstration. 9.50, Light act.

THURSDAY, APRIL 8th.

3, Musical act. 3.10, Architecture. 3.25, British Movietonews. 3.35, Extracts from "And so to Bed." 9, Repetition of 3 and 3.10 programmes. 9.25, Gaumont-British News. 9.35, Repetition of 3.35 programme.

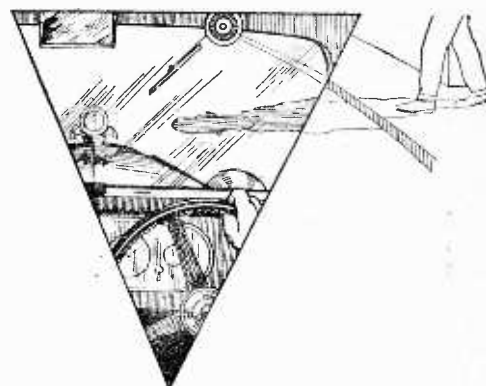

ANTICIPATION

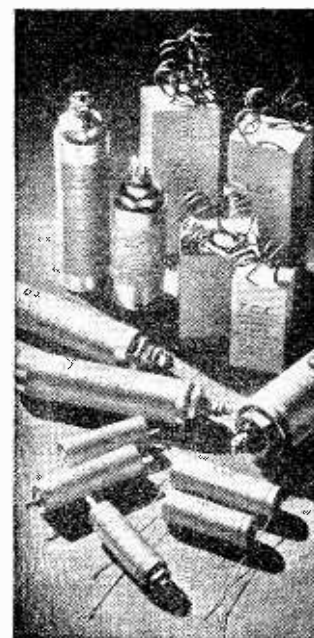

To anticipate is to know beforehand, it is that extra sense which experience alone can

develop. Specialisation in one product alone for over 28 years has brought to T.C.C. the keenest sense of anticipation. Long before many condensers were actually needed by the industry, T.C.C. had them designed, built and proved ready for the needs of to-morrow. Those condensers are now accepted as standard types.

Weekly T.C.C. evolve new types; they too, are ready for Radio's and Television's ever more critical demands.

T.C.C.
ALL-BRITISH
CONDENSERS

THE TELEGRAPH CONDENSER CO., LTD.,
WALES FARM ROAD, N. ACTON, W.3

Broadcast Brevities

NEWS FROM
PORTLAND
PLACE

The New Empire Station

SIR NOEL ASHBRIDGE, Chief Engineer of the B.B.C., is to meet a large gathering of Press representatives at Broadcasting House on April 6th to explain the progress that has been made with the new Empire transmitters at Daventry and to tell of the prospects of getting everything ship-shape in time for the Coronation broadcasts. The sooner these high-power transmitters are in operation the better; not for the Coronation in particular, but for policy reasons in general. The amount of jamming by foreign stations of the Empire programmes is causing some anxiety in the Dominion of Canada, and representations have been made to the Government on the strength of complaints received by the B.B.C. Lady Bridgeman, a B. B. C. Governor, spilt the beans when she admitted the need for counter-propaganda; but the kind of propaganda that the Empire

TELEVISION ACTIVITY on Coronation procession route. Engineers outside Buckingham Palace laying the co-axial cable between Whitehall and Hyde Park Corner in preparation for probable television transmissions.



station will feature will be by way of giving Empire listeners more and better entertainment programmes.

Coronation Broadcast Plans

BROADCASTING plans for Coronation Week can now be seen in bold perspective. The first impressive item will be at 8 p.m. on Sunday, May 9th, when the Archbishop of Canterbury conducts a "Service preparatory to the Coronation" in the Concert Hall of Broadcasting House. This will be radiated nationally. "Merrie England," Edward German's light opera, will also be included in the National programme on the same evening. The story of the "King's Anointing" will be told on the Regional wavelengths.

The King's Broadcast

Sir James Barrie's play, "Dear Brutus," will be heard on Monday, and on the Tuesday there will be a gala revue lasting an hour and a half.

On May 12th, in addition to the Coronation broadcast lasting over three hours, there will be a "Round the Empire" programme in the evening culminating at 8 o'clock with a personal broadcast by His Majesty the King.

Dancing Round Britain

Guests at a Grand "Coronation Party," starting at 8.15 p.m., will include Clapham and Dwyer, Elsie and Doris Waters, and The Two Leslies, and the fun will go on till 9.30.

To wind up the day and begin the next there will be a dance band tour round Britain lasting until 1 a.m.

Return of A. J. Alan

Coronation music through the centuries will be heard in a special concert by the B.B.C. Orchestra, Chorus and Singers, conducted by Sir Adrian Boult, on May 13th. The one and only A. J. Alan will come out of his shell at 9 p.m. on May 14th to give Regional listeners a Coronation story. Nationals will get it at 10.30 p.m. on May 15th.

chestra of its own. This gives an idea of the enormous cost involved in keeping a combination like the B.B.C. Dance Orchestra going. It is an open question whether the smaller combination which Henry Hall was given when he went to Broadcasting House five years ago should not have sufficed permanently for studio purposes, thus avoiding any question of having to save on the swings what must compulsorily be paid out on the roundabouts.

Filling the Gap

How will the B.B.C. spend this £15,000? Definitely, it would appear, on dance band broadcasts, without diverting any portion of it to other programme interests. We may expect to have more studio performances by leading dance band organisations, such as those of Jack Hylton, Ambrose, Billy Cotton, Van Phillips, and Jack Payne. It should be a matter for self-congratulation by Henry Hall that it is likely thus to take a host of contemporaries to fill the gap which he will leave.

Pamphleteers' Dilemma

THE twin dangers facing people who prepare booklets about broadcast talks are (a) that the booklets may be uninformative and likely to repel rather than attract listeners, and (b) that they may be so informative and attractive as to make it unnecessary to listen to the talks.

By skill or chance, or a mixture of both, the new Summer Talks booklet steers between Scylla and Charybdis, with room to spare.

What Do They Want ?

A sad note is struck in a foreword written by Sir Richard Maconachie, the new Director of Talks: "I shot an arrow into the air, It fell to earth I know not where," quotes Sir Richard, in explaining how difficult it is to gauge the needs of the unseen and generally unresponsive audience. But he hopes that the measures now being taken by the Corporation to ascertain the needs and desires of the unknown millions may give him and his assistants the data which may help them to correct their range and aim. May such magnificent hopes not be confounded.

The Broadcast Talks pamphlet can be obtained free from the B.B.C. Publishing Dept., 35, High Street, Marylebone, London, W.1.

Expensive Dance Music

IT is estimated that after having paid increased fees for broadcasts by outside dance bands running annually into five figures, which was the result of the recent negotiations between the Dance Band Leaders' Association and the B.B.C., the Corporation will still save some £15,000 a year through dispensing with a dance or-

Letters to the Editor

Reception on 28 Mc/s

I FOUND the article by R. A. Watson Watt, "Wireless and the Atmosphere—a new chapter," very interesting. For some time I have been observing frequencies higher than 25 Mc/s, particularly the 28 and 56 Mc/s amateur bands, and possibly the newly discovered low level layers will explain the rather puzzling effects observed on 28 Mc/s. I refer to the reception of signals over distances of between 50 and 500 miles. Signals from amateur stations at these distances are heard with surprising regularity and very little fading. The chief points distinguishing this type of signal (a) from those received in the summer over similar distances by high angle refraction (b) are these:

(a) Exceptionally reliable, very little fading, low values of signal strength, audible

The Editor does not hold himself responsible for the opinions of his correspondents

throughout day until two or three hours after dark in winter and summer? (see note later), apparently not affected to any great extent by general conditions for longer distances.

(b) Spasmodic, considerable fading, temporary high values of signal strength, audible at irregular times, mostly during daylight in summer months, considerably affected by general conditions.

The type (a) signals have been so reliable that we have come to term them "elongated ground waves"! There is some doubt as to whether they are receivable in summer, due

to the lack of amateur activity at this time of year, but it is hoped to obtain further information on this question during the coming summer. At present signals are heard daily from most parts of England and the nearer continental countries up to 500 miles, approximately.

Some time ago, before we heard of these new low level layers I put forward the suggestion that the type (a) signals were heard only after they had been completely round the world, for the following reasons: Code signals from stations situated between 25 and 100 miles distant on certain days are heard with echoes which are so strong as to make their ground waves unreadable, as the echoes are practically as strong and of about $\frac{1}{16}$ second delay. It has been noted that signals from 100-500 miles distant have been particularly good when conditions have been good for Japan and New Zealand, and at the same time the nearer stations have echoes (i.e., 25-100 miles). The former signals are seldom heard with echoes. It is obvious, therefore, if the ground wave were not audible we should be able to read the echo! For a signal to go completely round the world it is, presumably, necessary that the ionisation over the route be fairly uniform and not too intense, so that the signal is not refracted back to earth, but gradually bent round the earth's periphery. This condition is fulfilled in the mornings in the Northern Hemisphere during autumn, winter and spring if the signal follows a route north-east from, say, England. If we trace a great circle in this direction it will be seen that the signal will pass over Northern Europe, Russia and Siberia during the period of maximum daylight, but here the ionisation will be low. Continuing the great circle we come to Japan and New Zealand, where it is evening, and although nearer the equator the ionisation will not be too great since the sun's effect is removed. Next we come to the Southern Pacific and South America, where it will be midnight (but during the summer there), and this will be the region of lowest ionisation, but even here it appears to be sufficient to bend the signal, since signals have been heard from South America in the early mornings here. Thus the signal would return to England!

There is still, I think, reason to suspect that some of the signals are "round the world" type, but it certainly appears that the new low layers will explain the reception of the majority of them. As a contrast to the above discussed 28 Mc/s signals transmissions on 56 Mc/s are not heard over distances far in excess of the optical range (except by high-angle refraction and spasmodically during summer months, also very occasionally over long distances at other times of year, i.e., over 1,000 miles).

D. W. HEIGHTMAN.

Gt. Clacton, Essex.

"Flutter"

AS one who has spent some time investigating this subject, I was interested in your correspondent's letter on this subject in your issue of February 26th.

While the writer seems to have discovered most of the remedies, I cannot agree that his explanation of the trouble is the correct one, since this trouble does occur in receivers employing single AVC or no AVC at all.

In my opinion, it is due to the use of heptode and similar frequency changers, probably caused by internal capacity change of the valve with varying anode voltages.

The remedy is to employ a frequency changer which has an entirely separate oscil-

lator section, an additional advantage, of course, being the reduction of wander due to the same cause.

I append a copy of part of my report on the subject which may interest other readers faced with the problem.

G. H. BRADBURY, Chief Engineer,
Ewell, Surrey. Fourwave, Limited.

"FLUTTER" AND "WANDER" IN SHORT-WAVE RECEIVERS.

"Flutter" occurs on all models employing a single output valve and consists of a periodic variation of signal strength at frequencies above approximately 9 Mc/s. The defect becomes more acute as the signal strength is increased or the volume control turned up, until a stage is reached when the signal alternately ceases and recommences about five times per second.

"Wander" refers to the variation from the original tuning position of stations working on frequencies above 9 Mc/s (approx.) occurring on all models but to a greater extent on receivers with single pentode output stages.

It has been found that a peculiarity of the heptode is the variation of oscillation frequency with changing anode volts; i.e. at 17.8 Mc/s an anode voltage variation of 15 per cent. causes complete detuning of the signal so that it is inaudible till retuned. The same anode voltage change at 15.3 Mc/s so detunes the signal as to make it unintelligible.

It is clear, therefore, that any change in the total anode supply due to changing signal strength or loading of the output valve must affect the oscillating frequency of the heptode and it is this peculiarity therefore which causes the above-mentioned defects.

A brief description of the cycle of operations will make this clear. A signal of good strength will so swing the grid of the output valve as to cause a large current variation in this valve, and consequently a momentary change of anode voltage. When this occurs the heptode ceases to oscillate at the correct frequency and the signal stops. When the signal ceases the original anode voltage is restored and the heptode then oscillates once more at its correct frequency, again swinging the output valve grid and repeating the trouble, thus producing the "flutter."

"Wander" is caused by the fading of the signal itself, causing, by means of the AVC, increasing demands on the anode supply and therefore a reduction in the voltage. Automatic volume control at the higher frequencies therefore defeats its own object, often causing a complete cessation of the signal which might still be at good strength.

Undoubtedly the best cure is to replace the heptode with a valve not subject to the trouble, and by employing a triode-pentode the trouble has been overcome. A receiver employing a triode-pentode as oscillator does not detune at all even when the voltage is varied as much as 35 per cent.; and flutter and wander do not occur at any frequency or volume.

When a heptode frequency-changer is employed, the following remedies will be effective.

1. If a push-pull output stage is used the anode voltage is maintained constant at loud volume, since an increased anode current in one valve is compensated by a corresponding reduction in the other; hence the absence of flutter in push-pull models. The use of two output valves biased from the negative HT supply also reduces the wander since they automatically take less current as the demand by the RF valves increases.

If the current variation in the field coil at the bias tap is 4.4 milliamps per volts (equal to the slope of the two output valves), the HT voltage will remain constant whatever the signal strength, but it would be difficult to obtain this condition in practice.

2. The use of a very large capacity condenser (75 mfd.) to the oscillator anode resistance, in conjunction with an additional 5,000-ohm resistor, will maintain the voltage constant during the brief anode current variations in the output valves, provided these variations are not large (i.e. at about $\frac{3}{4}$ volume at 17.8 Mc/s).

POINTS OF IMPORTANCE
in the Rola
G.12



THE ACID TEST

There are many ores that look like gold, but none that can stand the acid test to which all baser metals succumb. The acid test of a good radio receiver is the speaker with which it is equipped. If it is a G.12 you can be sure that the whole set is built to the same high standard, for it would pay no manufacturer to install a G.12 in any receiver that was not in every respect a "quality" set. That radio connoisseurs have been quick to appreciate this fact is shown by the unique sales increases reported by all manufacturers concerning models fitted with G.12 speakers. It pays them and it pays you to specify a G.12 if you want the highest quality reproduction even though the first cost may appear comparatively high.

G.12 P.M. (as illustrated) less Transformer	£4 16 0
G.12 P.M. with Transformer	£5 5 0
G.12 D.C. Complete with Transformer, Mounting Stand, Handle and Base	£5 5 0
G.12 D.C. with Mounting Stand, Handle and Base, but without Transformer	£4 16 0
G.12 D.C. Stripped, but with Transformer	£4 4 0
G.12 D.C. Stripped and without Transformer	£3 15 0

(When ordering please state Field Resistance and Impedance of Transformer required.)

For Public Address work both the P.M. and Energised Models can be supplied with a 15 ohm Voice Coil at an additional charge of 3/-.

Write for Folder A.

OVER 8 MILLION IN USE

ROLA

The World's Finest Reproducers

THE BRITISH ROLA CO., LTD.
MINERVA ROAD, PARK ROYAL, N.W.10.
PHONE: WILLESDEN 4322-3-4-5-6.

Brief descriptions of the more interesting radio devices and improvements issued as patents will be included in this section.

Recent Inventions

INTERVALVE COUPLINGS

AN intervalve coupling, suitable for passing a wide range of frequencies as in television, consists of two high-frequency chokes coupled together as tightly as possible. The natural frequencies of both windings are equal, and both are less than the unmodulated carrier frequency, whilst the inherent shunt capacity between the windings is made as small as possible. Damping resistances, of sufficient value to render the circuits non-oscillatory, are shunted across both primary and secondary windings.

Radio Akt. D. S. Loewe. Convention date (Germany) June 5th, 1934. No. 457773.

LIGHT RELAYS

TWO photo-electric cells are arranged, in conjunction with the same amplifier, so that "fatigue" effects are counter-balanced. As shown at (a) in the figure, one cell, C, is connected between the grid of the valve V and the negative end of the supply potentiometer P, whilst the second cell C1 is arranged between the same grid and a positive tapping on the potentiometer.

The two cells are mounted in a casing as shown at (b), so that each is subjected to the light from lamps L, L1, at opposite ends. The lamps are adjusted until the positive current through one cell balances the negative current through the other, on the grid of the amplifier V, so that the output from the latter remains constant. The combination will then respond to any additional source

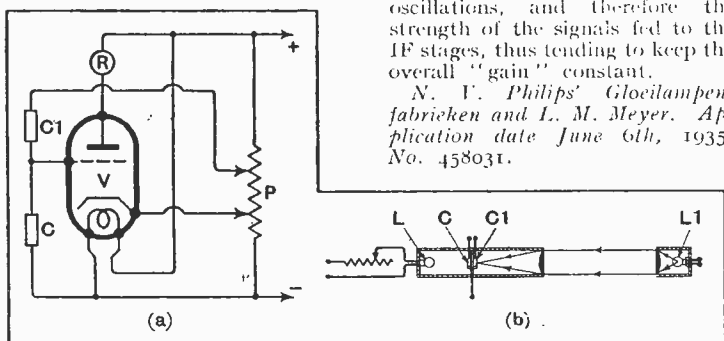

Arrangement of photo-cells to balance out "fatigue" effect.

of illumination without showing any "fatigue." The resulting current from the amplifier is used to operate a relay, R.

S. Vasilach. Convention date (France) June 6th, 1934. No. 458032.

AVC SYSTEMS

THE "gain" of a wireless receiver is automatically controlled by regulating the effective amount of back-coupling in the circuit.

As shown the valve V is the local oscillator of a superhet set, whilst V1 is the second detector, and V2 the AVC valve. It will be seen that the valve V2, in series with a condenser C, is shunted across the anode coil of the local oscillator. The grid of V2 is biased through a tapping from a resistance R in the plate circuit of the detector V1.

For signals of normal strength the grid-bias is sufficient to render the valve V2 non-conducting, so that it is out of operation. As signal strength increases, however, the voltage from R throws the

grid of V2 more positive, and so allows some of the output from the local oscillator V to be diverted through the condenser C. This reduces the amplitude of the local oscillations, and therefore the strength of the signals fed to the IF stages, thus tending to keep the overall "gain" constant.

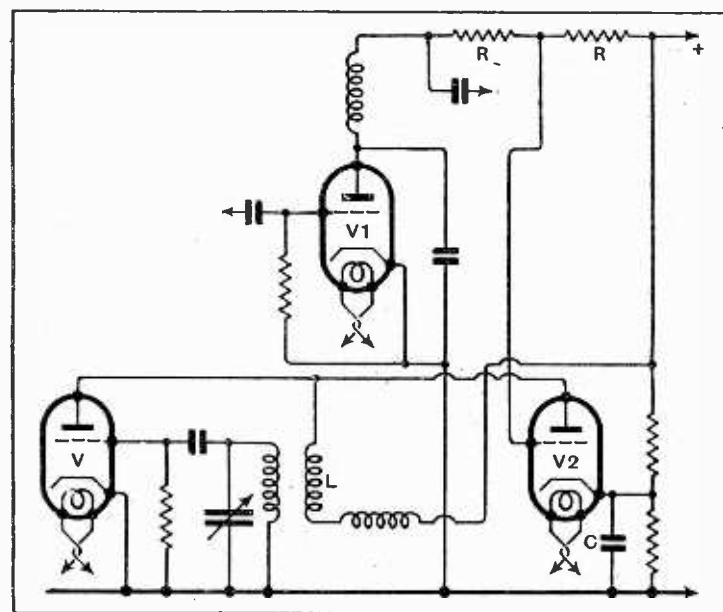

Method of obtaining constant amplification in a superhet receiver.

N. V. Philips' Gloeilampenfabrieken and L. M. Meyer. Application date June 6th, 1935. No. 458031.

NAVIGATION BY RADIO

A KNOWN method of guiding an aeroplane in flight is to use a course marked out by the "overlap" between two directed beams of radiated waves. Each beam is differently modulated, so that in the overlapping section the two modulating notes combine to give a third characteristic signal, which is heard by the aviator so long as he follows the correct path.

According to the invention this system is elaborated in order to

give a clearer indication of the required route. Instead of two beams, two pairs of beams are used. The first pair are transmitted on the same wavelength, though both are differently modulated. The area of overlap is made as narrow as possible, and is distinguished by a third signal produced by the merging of the two modulation notes.

The second pair of beams is similarly arranged, except that both beams are transmitted on a different wavelength from the first. They, too, are differently modulated, and the characteristic signal

SHORT-WAVE VALVES

A SPLIT-ANODE valve of the magnetron type is designed to have dimensions definitely related to the working wavelength. For instance, the diameter of the cylindrical anode, measured in millimetres, is greater than twice the received signal wave measured in metres, and is preferably twenty times as much, and the length of

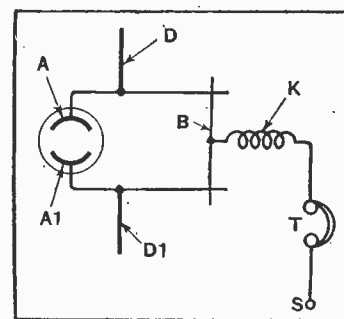

Valve and circuit designed for micro-wave reception.

the cylinder is not greater than the diameter.

As shown the signals are received on the two halves of a dipole aerial D, D1 which is connected to a Lecher-wire circuit bridged across the split anodes A, A1. The circuit is tuned by a sliding bridge B to which high tension is applied through a choke K from the source S. The telephones are inserted at T. The Lecher-wire circuit may be tuned to an harmonic of the signal frequency, in order to give super-regenerative or superheterodyne reception, the valve being brought to the point of self-oscillation by adjusting the filament heat.

C. Lorenz Akt. Convention dates (Germany) February 25th; April 10th; and August 16th, 1935. No. 457721.

AUTOMATIC TUNING CONTROL

PROVISION is made for automatically correcting for any slow frequency changes, either of the incoming carrier wave, or of the local oscillations, in a highly selective type of superhet receiver. Frequency "drift," particularly of the local oscillator, may be caused by changes in temperature, and would in the ordinary way necessitate retuning of the circuits from time to time.

According to the invention, the output from the final high-frequency stage is fed to a balanced detector through two parallel paths, one of which is highly selective, while the other is more broadly tuned. The latter includes a phase-adjusting network, so that the two branches of the output reach the balanced detector in phase-opposition. The detector "bridge" remains balanced only so long as the circuits are accurately in tune. Any departure from this condition, due to frequency drift, unbalances the bridge and so varies the impedance of a control valve. This, in turn, develops a voltage which is applied to the screen grid of a pentode valve, used as the local oscillator, and varies its frequency in the sense necessary to restore the correct tuning of the receiver.

Kolster-Brandes, Ltd., and C. W. Earp. Application date, May 30th, 1935. No. 457485.

The British abstracts published here are prepared with the permission of the Controller of H.M. Stationery Office, from Specifications obtainable at the Patent Office, 25, Southampton Buildings, London, W.C.2, price 1/- each. A selection of patents issued in U.S.A. is also included.

USED IN THE CITY • USED IN THE PROVINCES • USED ON THE CONTINENT • USED IN THE COLONIES • USED THE WORLD OVER

The finest investment you can make



If you could only see the way Parmeko equipment is built you would have immediate confidence in it. Parmeko Ltd. is a factory of specialists each combining to produce for you the finest equipment built. Parmeko has rivals, but no equals, that is why we say invest in Parmeko equipment, it will amply repay you by giving true tone, unlimited power and years of trouble-free service.

P.A. Equipment

Technical details, prices and trade terms on application.

PARMEKO LTD.

Builders of Microphones, Loud-Speakers, Amplifiers, etc., etc.

AYLESTONE PARK, LEICESTER



Make a Note of it—Now!
Be sure to get your copy of

**The
Wireless
World**

DIARY FOR 1937

Every wireless enthusiast should have this handy little diary. In addition to the usual pages—one week at an opening—it contains 76 pages of facts, formulæ and general information of the kind that is always wanted but is difficult to memorise.

There is a complete list of European Broadcasting Stations and Short-wave Stations of the World. In addition an important section contains all the recognised codes relating to components, as well as useful tables of resistance ratings. There are also nine pages of base connections of British and American valves.

Sixteen pages of circuit diagrams of receivers, amplifiers and such units as whistle suppressors, tone controls and AVC systems are included. Valuable information is given on the prevention of mains interference and data for winding coils.

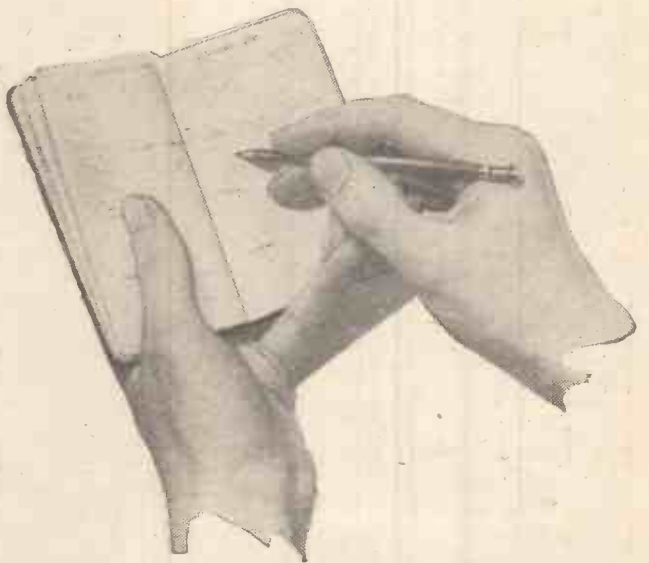

Size 3½ by 4½ inches, 192 pages. Bound leather cloth, back loop with pencil.

PRICE 1/6 net.

By post 1/7

From bookstalls and stationers, or direct from the publishers

ILIFFE & SONS LTD., DORSET HOUSE, STAMFORD STREET, LONDON, S.E.1

W.W.75.

Mention of "The Wireless World," when writing to advertisers, will ensure prompt attention.

MISCELLANEOUS ADVERTISEMENTS

NOTICES

THE CHARGE FOR ADVERTISEMENTS in these columns is

12 words or less, 3/- and 3d. for every additional word.

Each paragraph is charged separately and name and address must be counted.

SERIES DISCOUNTS are allowed to Trade Advertisers as follows on orders for consecutive insertions, provided a contract is placed in advance, and in the absence of fresh instructions the entire "copy" is repeated from the previous issue: 13 consecutive insertions 5%; 26 consecutive, 10%; 52 consecutive, 15%.

ADVERTISEMENTS for these columns are accepted up to **FIRST POST ON MONDAY MORNING** (previous to date of issue) at the Head Offices of "The Wireless World," Dorset House, Stamford Street, London, S.E.1, or on **SATURDAY MORNING** at the Branch Offices, 19, Hertford Street, Coventry; Guildhall Buildings, Navigation Street, Birmingham, 2; 260, Deansgate, Manchester, 3; 26a, Renfield Street, Glasgow, C.2.

Advertisements that arrive too late for a particular issue will automatically be inserted in the following issue unless accompanied by instructions to the contrary. All advertisements in this section must be strictly prepaid.

The proprietors retain the right to refuse or withdraw advertisements at their discretion.

Postal Orders and Cheques sent in payment for advertisements should be made payable to **ILIFFE & SONS Ltd.**, and crossed **& Co.** Notes being untraceable if lost in transit should not be sent as remittances.

All letters relating to advertisements should quote the number which is printed at the end of each advertisement and the date of the issue in which it appeared.

The proprietors are not responsible for clerical or printers' errors, although every care is taken to avoid mistakes.



Last week a customer told us off for writing bad advertisements. He said: "Week after week you've talked about the Duode-de-Luxe speaker and the M.A. receiver; but you have only once shown the speaker response curve, and you haven't ever given a technical specification of the receiver, so I still don't know whether I want it or not."

Was he right? We still say **NO!** The response curve of a speaker doesn't tell all the story. Our speakers all have good response curves, but that doesn't prove that they are good speakers. This is *our* idea of proof:

"About a fortnight ago you converted my Hartley-Turner speaker to the Duode principle. Since then I have tried it out very thoroughly, and I must say that it is all and more than you claim.

"My receiver . . . has a flat response from 32 to 15,000 cycles and is equal to anything broadcast. I have had every latest Hartley-Turner speaker as it appeared, but the Duode is the finest thing yet.

"To my critical ear the flatter response is a joy, and the increased 'stereoscopic' effect a delight."

Similarly, neither a technical specification nor even a schematic of a receiver gives much indication of its powers. We prefer this sort of thing (based on an early model, not so good as the production type):

"I have had the sample M.A. running this week-end, and I am amazed at the quality of its reproduction.

In reply to your questions:—

1. Quality of local reception . . . Outstandingly good.
2. Quality of distant reception . . . Much above normal.
3. Freedom from interference . . . See separate sheet.*
4. Ease of handling to get the very best . . . Simple for a person who knows when reproduction is O.K.
5. When handled by quite unskilled people . . . Quite simple if directions are followed.

* This showed that of 30 stations tried for, 13 were "very good," 6 "good," 4 "fair." In 4 only the set was not selective enough, and 3 were spoilt by low beat notes, excessive fading, etc., which no set can deal with.

Our contention is that an advertisement should give an idea of the general purpose of the article, and its price: details are best given in leaflets which are available for the asking.

So if you are interested, write to us—or, better still

COME AND HEAR.

HARTLEY TURNER RADIO LTD.,

THORNBURY ROAD,

ISLEWORTH, MIDDLESEX.

Telephone: HOUNslow 4488

NUMBERED ADDRESSES

For the convenience of private advertisers, letters may be addressed to numbers at "The Wireless World" Office. When this is desired, the sum of 6d. to defray the cost of registration and to cover postage on replies must be added to the advertisement charge, which must include the words Box 000, c/o "The Wireless World." All replies should be addressed to the Box number shown in the advertisement, c/o "The Wireless World," Dorset House, Stamford Street, London, S.E.1. Readers who reply to Box No. advertisements are warned against sending remittance through the post except in registered envelopes: in all such cases the use of the Deposit System is recommended, and the envelope should be clearly marked "Deposit Department."

DEPOSIT SYSTEM

Readers who hesitate to send money to advertisers in these columns may deal in perfect safety by availing themselves of our Deposit System. If the money be deposited with "The Wireless World," both parties are advised of its receipt.

The time allowed for decision is three days, counting from receipt of goods, after which period, if buyer decides not to retain goods, they must be returned to sender. If a sale is effected, buyer instructs us to remit amount to seller, but if not, seller instructs us to return amount to depositor. Carriage is paid by the buyer, but in the event of no sale, and subject to there being no different arrangement between buyer and seller, each pays carriage one way. The seller takes the risk of loss or damage in transit, for which we take no responsibility. For all transactions up to £10, a deposit fee of 1/- is charged; on transactions over £10 and under £50, the fee is 2/6; over £50, 5/-. All deposit matters are dealt with at Dorset House, Stamford Street, London, S.E.1, and cheques and money orders should be made payable to Iliffe & Sons Limited.

SPECIAL NOTE.—Readers who reply to advertisements and receive no answer to their enquiries are requested to regard the silence as an indication that the goods advertised have already been disposed of. Advertisers often receive so many enquiries that it is quite impossible to reply to each one by post. When sending remittances direct to an advertiser, stamp for return should also be included for use in the event of the application proving unsuccessful.

NEW RECEIVERS AND AMPLIFIERS

A. A. DEGALLIER'S Ltd., the firm for reliable short wave radio, have on show in London the largest selection of fully guaranteed brand new all-wave receivers; callers invited to handle all these at their leisure without obligation to purchase; all S.W. receivers will get stations on the low bands, including the Americas, etc. Hours of business 11 a.m.—7 p.m. Closed all day Mondays. All goods cash with order or c.o.d. Handsomely illustrated catalogues forwarded on receipt of large stamped addressed envelope or stamp 2½d. Our models receive American transmissions at full programme strength; demonstrations daily after 4.30.

VALVES, every one brand new, not seconds or rejects. Even if it is not shown here we have it. 01a, 1a6, 1c6, 1f4, 1v, 2a3, 2a5, 2a6, 2a7, 2b7, 5z3, 6a4, 6a6, 6a7, 6b7, 6c6, 6d6, 6e5, 6f7, 6g5, 10, 12a, 12a5, 12a7, 12z3, 12z5, 15, 19, 22, 24, 25a (1b5), 25z5, 26, 27, 30, 31, 32, 33, 34, 35 (use 51), 36, 37, 38, 39-44, 41, 42, 43, 45, 46, 47, 48, 49, 50, 51, 53, 55, 56, 57, 58, 59, 71a, 75, 76, 77, 78, 79, 80, 81, 82, 83, 83v, 84 (6Z4), 85, 89, 99v, 99X, P.Z., P.Z.H., Wunderlich Glass Counterparts, 5W4g, 5Yz, 6A6G, 6X56, 6B6, 25A6G, 6C5G, 25Z6g, 6F5G, 6H6G, 6J7G, 6K7G, 6L7G, 6N6G, 6N7G, 6P7, 6Q7G, 6R7G, 25N6G. Metal Valves, 5Z4, 6a8, 6b5, 6c5, 6f5, 6l6, 6j7, 6k7, 5y3, 5w4, 6j7, 6n6, 6n7, 6q7, 6r7, 6x5, 25a6, 25z6. All metal replacement types for glass valves, 2a6, 2a7, 51, 55, 56, 57. All the above 6/6 each. Line cords for any Midget receiver, 4/9 each.

£3/10—T.R.F. Midget receiver, "The smallest of its type in the world," medium and long wavebands, moving coil speaker, 2 watts output, no earth required, compact and transportable, leather cloth covered, obtainable in various colours; carriage 1/-.

£7/7—Table model six-valve all-wave superhet, tuning 16½-50, 200-550, 800-2,000 metres, high efficiency resistance-capacity circuit with A.V.C., station calibrated dial, 8in. moving coil speaker, cabinet of handsome appearance and super acoustic, 17x13x9½, operates on A.C. or D.C. mains, 200-250 volts; never before such tone from a D.C. receiver, carriage 4/6.

13 Gns.—The new Challenger 8 (type 800) table model De Luxe, 22x18x12, high fidelity 8-valve superhet, A.C. 200-250 volts, waveband coverage 11-32, 27-65, 180-550, 900-2,000 metres, simplified centralised tuning, super slow motion vernier slow-fast tuning dial calibrated in meters, with station names, self contained control panel, perfect tone quality at low volume, new type, A.C. 10in. speaker, from a whisper to 8 watts pure undistorted tone, no overloading at full volume, oscillator fundamental without use of harmonics, persistent oscillator of highest output, isolating filters eliminate oscillation and motor boating, fully delayed A.V.C., P.U. terminals (switching and volume control incorporated in the front panel), absolute minimum of noise, sensitivity control for noise suppression. Reinforced capacitors prevent drift, pre-aged intermediate frequency transformers, I.F. barrier discs, anchor coil leads, plug-in loudspeaker, moisture sealed out by tropical zone impregnation, self

(This advertisement continued in third column.)

NEW RECEIVERS AND AMPLIFIERS

(This advertisement continued from first column.)

heating electrolytic condensers. One complete chassis of dreadnought construction. Moderate voltages assure full valve life. Economical to operate, 70 watts consumption. Correct valve selection, no compromise, no hum. Full weight transformers. True push-pull. Stabilised H.T. supply. Stabilised biases. Ceramic coil insulation. Fully loaded plate coils give maximum gain. Pre-balanced coil assembly. Sealed insulation, thin laminations of special silico steel, 7 k.c. selectivity. Fractional microvolt sensitivity. Shielded switching permits high gain. Positive silver plated contacts eliminates switch noises. Audio frequency range 50-8,000 cycles. Diode detection. Prism-tone high fidelity. R.F. selector stages on all bands. Carriage 5/6.

£12/18—"800" chassis valves and 10in. speaker; carriage 4/-.

£14/18—"800" chassis valves and G.12 12in. Rola high fidelity speaker; carriage 6/-.

NOTE.—The Challenger 800 is available in A.C./D.C. 200-250 volts, employing 11 valves at an additional cost of 20/- on each model.

14 Gns.—Challenger 381 8-valve 14-2,060 metres, Poly-chromatic dial scale, improved vision master, beam power output, band spread Magna dial and second-hand magic eye tuning, automatic band indicator, high image frequency suppression, hair line selectivity, 5 k.c. separation; carriage 5/6; less cabinet, £13/18; carriage 4/-.

17 Gns.—Challenger 8 Console "800C" height 3ft. 6in., width 24in., depth 12½in.; this is the 800 chassis with G.12 speaker, carriage and crate, 10/-.

29 Gns.—Challenger "800R.G." radiogram, with automatic changer "Garrard"; this job also incorporates the G.12 Rola; carriage and crate, 15/-; A.C./D.C. model, £2 extra.

DEGALLIER'S Ltd., 18, Connaught St., Marble Arch, London, W.2. Paddington 2745. [4127]

ALERT RADIO Co.

COMMUNICATION Receivers, all-wave chassis, complete receivers of all types, American valves, spares and service; we also have a few reconditioned receivers.—21, East Rd., N.1. Clerkenwell 4871. [3787]

LEEDS For Hallcrafters.

£9, Sky-Buddy; £12/15, Sky-Chief; £24, Sky-Challenger; £28/10, Super Sky Rider; £32/10, Ultra Sky Rider; all fully guaranteed.

LEEDS, 66, New Briggate, Leeds. [4070]

"SERVICE With a Smile."

HENRY FORD RADIO, Ltd.

ELECTRONIC House, 22, Howland St., Tottenham Court Rd., W.1. Museum 5675. [9511]

NEW RECEIVERS AND AMPLIFIERS

AIR KING.
ALL Models Feature Beam Tuning. Magic Eye indicator, gramo, pick-up connections, and special output valves.
ALL Sets Fully Guaranteed; H.P. terms available from 3/- per week.
WHOLESALE and Trade Enquiries Invited; generous terms.
ALL Types of American Valves Stocked, write for lists to
AIR KING RADIO, 115, Shaftesbury Av., Cambridge Circus, W.O.2. Phone: Temple Bar 4875 (2 lines). All receivers assembled in England. [3406]
ROYAL RADIO Co.
ALL-WAVE Receivers, suitable for use on ships, as supplied to officers of many shipping lines.
OUR 8 and 10 Metal Valve All-wave Receivers; 15-2,000 metres, acknowledged by the trade as the best for range, tone, and general performance.
LATEST 6-valve Car Radio, A.V.C., remote control, no suppressors required.
A FULL Range of the World Famous Ferguson and Pilot Models Stocked.
ALL Sets Fully Guaranteed by Ourselves.
ALL Types of American Valves Stocked.
PAY Us a Visit Any Time, or send for full range catalogue; 1/2d. stamp will be appreciated.
ROYAL RADIO Co., 5, Buckingham Rd., South Woodford, London, E.18. Phone: Buckhurst 2736. [4111]
COULPHONE RADIO MANUFACTURING Co., Ltd., Hutton, Preston, Lancashire.
COULPHONE All-wave 6-valve Chassis, with R.F. stage, B.V.A. valves, 8in. Rola speaker, royalties paid; £8/10; twelve months' guarantee. [4143]
PILOT, Ferguson, Spartan, American transportable, car radio, and others; traders; lists.—Perseus Co., W.W., Burton-on-Trent. [4115]
HARMAUR RADIO for Wireless Receivers from £3/3; Raytheon glass and metal valves and all components; trade enquiries.
THE HARMAUR RADIO Co., Ltd., 8, Clifford St., New Bond St., London, W.1. [0499]
ARMSTRONG Radio Chassis are British and Represent Sound Value for Money; 8 models available. Please send for catalogue.
ARMSTRONG MANUFACTURING Co., 100, King's Rd., Camden Town, N.W.1. [4054]
MCCARTHY New Series of A.C., Universal, Battery, All-Wave and other receivers; many refinements at no extra cost; several interesting new models.
IMPORTANT!—All prices quoted for McCarthy chassis include Marconi Royalty payments.
MCCARTHY All-Wave Battery Superhet, with R/F stage; £7; separate triode oscillator, L.F. stage, pentode output, ext. speaker and gram. sockets, etc., equals mains performance.—(See McCarthy advertisement, page 335.)
MCCARTHY 6-valve All-Wave Superhet, with R/F stage; £8/5; A.C. or Universal, iron-cored I.F. coils, Litz-wound tuning coils, illuminated "Airplane" dial, triode-hexode frequency changer, double band-pass coupled I.F. amplifier, L.F. stage, pentode output, D.A.V.C., tone control, ext. speaker and gram. sockets, etc., etc., performance equals many 8-valve receivers.—(See McCarthy advertisement, page 335.)
MCCARTHY Super 9-valve All-Wave with Push-pull Triode Output; £12/12; 4 wave-bands (12.8-2,000 metres), R/F stage, triode-hexode frequency changer, 2 band-pass transformer-coupled I.F. amplifiers, double diode detector, L.F. amplifier, 5-6 watt output, D.A.V.C., tone control, ext. speaker, gram., etc., etc.
ALL McCarthy Receivers now on Heavy Cadmium-plated Steel Chassis; quality components and B.V.A. valves throughout.
MANY Other McCarthy Models. Write for complete catalogue.
MCCARTHY RADIO, Ltd., 44a, Westbourne Grove, London, W.2. [4126]
COULPHONE 6-valve All-wave Chassis, pre. H.F. frequency changer, I.F., H.F. pentode, D.D. triode, 3 1/2-watt pentode, rectifier, Rola G 12 or Magnavox "33"; £10/10.
THE COULPHONE RADIO MANUFACTURING Co., Ltd., Hutton, Preston, Lancashire. [4064]
TRANS-ATLANTIC RADIO for Latest and Finest All-wave Receivers and Compacts from 59/6. "Phileo" agents; radio repairs by experts.—Trans-Atlantic Radio Co., 15, Percy St., W.1. Museum 3096. [4095]
PILOT, Ferguson, Belmont, Pegasus, and Air King all-waves lead the field; our deliveries are prompt in original cartons, with full guarantees; your trade card will bring our wholesale catalogue from the authorised distributors.—Leonard Heys, 36; Henry St., Blackpool. [0530]
COMMUNICATION Receivers, Hammarlund, National, Hallicrafters, R.M.E.69, Tobe-Deutschmann; transmitters, Collins 45A, Peerless DX20, or built to order; American valves, microphones, Eddystone components.—A.C.S., Ltd., 52-4, Widmore Rd., Bromley. Phone: Ravensbourne 0156. [0550]

Notes

on the Suppression of Electrical Interference with Wireless Reception

B.S.S. 727

FOR THE CHARACTERISTICS AND PERFORMANCE OF APPARATUS FOR THE MEASUREMENT OF RADIO INTERFERENCE.



Belling-Lee noise measuring set to B.S.S. 727, fundamentally a 5 valve superheterodyne receiver. With variable alternators totalling 136 db. in 6 db. steps.

ANOTHER milestone towards compulsory suppression of interference at the noise source has just been passed by the publication of British Standard Specification No. 727 on "The characteristics and performance of apparatus for the measurement of radio interference." The significance of this event is that no law can be laid down until we have agreed:—

- (i) Safe methods of suppression.
- (ii) Methods of measurement of interference.
- (iii) The level to which interference must be suppressed at the source.

The first of these is covered by B.S.S. 613 and by technical advice available from the G.P.O. and suppressor makers. The second is covered by this new specification which in an appendix gives a complete description of a suitable interference measuring set. We are now all looking forward to an early issue of the third essential, namely, the level to which owners or manufacturers of electrical appliances are expected to suppress them; we anticipate this will be a figure not too difficult or expensive for the appliance owner, yet low enough to give listeners every chance of interference-free reception if they themselves take reasonable care in screening and filtering their receiving installation.

Now who will want these interference measuring sets? G.P.O. engineers, manufacturers of interfering electrical appliances, manufacturers of interference suppressors, radio installation engineers who are going to make a speciality of suppressing interference are a few who immediately suggest themselves.

Where can one get such a measuring set? They are not just glorified radio receivers; they are measuring instruments for direct reading of the acoustic annoyance value of interfering mains voltages of a few microvolt or field strengths of a few microvolts per metre. They have an agreed H.F. and L.F. band pass characteristic, attenuators calibrated in decibels, and are self re-calibrating for certain variables, using the thermal agitation noises in the first circuit as a standard signal. We are already supplying these instruments (Catalogue No. 310) complete with a mains filter network and all accessories at £78 net, calibrated for H.F. voltage measurements at the terminals of a machine. If field strength measurements are also required we charge £6 extra to cover portable vertical aerial and field strength calibration carried out by the G.P.O.

For electrical manufacturers who do not wish to purchase an instrument we carry out measurements at our factory or theirs, at a reasonable fee, and also prescribe the necessary suppression gear.

Write for authoritative literature on the subject "Interference Suppression," post free 1/2, and/or free literature on "Elimin-noise" all-wave anti-interference aerial and "Wireless Without Cracking."



Belling & Lee Ltd.
 Cambridge Arterial Road, Enfield, Middx.

No. 32.

NEW RECEIVERS AND AMPLIFIERS

ANGLO AMERICAN RADIO Offer the Finest Range of Bargains in Radio Chassis and Receivers.
2 Special Cash Bargains.—Limited number only; cash or c.o.d.; post 1/-, secure yours now.
37/6.—Powerful 3-valve all-wave battery chassis, 12-2,000 metres, gram. band-spread, 7 1/2 in. dial with short wave station names and map tuning scale. complete with valves; an unprecedented offer.
21/-.—Superheterodyne short-wave converters, 7-200 metres, 5in. dial with band-spread, operates in front of any superhet or receiver with H.F. stage, mains or battery, complete with valves and cabinets, aerial tested.
4 D. in Stamps Enclosed Brings Our New Coronation Bargain Catalogue, 2 colours, fully illustrated; complete receivers 4v. A.C./D.C. to 10-valve 5 band, 10 watt at lowest prices in the country.
IF in Town Visit Our New Showroom and Coronation Display at Banham House, 59, New Oxford St.; full demonstrations without obligation.
ANGLO AMERICAN RADIO (AND MOTORS), Ltd. (Dept. W.11), Albion House, 59, New Oxford St., London, W.C.1. (Temple Bar 3231.) [4146]

RECEIVERS AND AMPLIFIERS CLEARANCE, SURPLUS, ETC.

HENRY'S,
1937 Regentone De Luxe Model A.C. 200-250 3 waveband Superhet. 5 valves, 17.5 to 2,000 metres, handsome cabinet; list 12 1/2 gns., our price £7.
1937 Regentone 3 Waveband, A.O. 200-250, 17.5 to 2,000 metres, thermometer tuning; list 9 gns., £4/10.
1936 Regentone 5-valve Consolette, A.C. 200-250, thermometer tuning; list £10/10, £4.
1937 Regentone 3-valve Battery Set, H.F. pentode, det. and pentode output, moving coil speaker, thermometer tuning; list £6/2/6, £3.
REGENTONE Short Wave Converter for A.C. Mains, complete with valves, 6.5 to 80 metres, no coil changing; list £4/19/6, £2/12/6.
FARREX Short Wave Units for A.C. Mains or Battery Sets; list £3/3, only a few left for 30/-.
HENRY'S, 72, Wellington Av., London, N.15. Stamford Hill 2907. [4075]
CLEARANCE List (Trade Only).—Write Leonard Heys, 36, Henry St., Blackpool. [0527]
ARMSTRONG COMPANY Have for Disposal Several (1937) 6-valve Radiogram Chassis, brand new and perfect, but cellulose slightly scratched. These genuine Armstrong chassis incorporate all latest superheterodyne practice, cover 200-2,000 metres, have tuning scales clearly marked with station names, volume and tone controls work on both radio and gramophone, etc., for 200-250 A.C. mains.
ARMSTRONG Chassis as Above are Supplied Complete with New Full Size Rola Moving Coil Speaker and 6 British valves, accurately ganged and ready to switch on; £5/10.
ARMSTRONG Co. Will Willingly Send, Above Chassis and Rola Speaker on 7 Days' Trial, carriage and packing free.
ARMSTRONG MANUFACTURING Co., 100, King's Rd., Camden Town, N.W.1. [4053]

PUBLIC ADDRESS EQUIPMENT SPECIAL Offer!!!

81 Guinea Assembled: Vortexion 20 watt 4-stage P.A. amplifier, in steel case, 8in.x10in.x9in. high, with carrying handle, input with controls for microphone and pick-up and tone control, output for 7 1/2 and 15 ohm speakers, weight 25lb.; only 8 1/2 guineas, with valves.
4 Input Model, with mixers; £10.
HEAVY Duty Model, as fitted to cinemas and dance halls; £15.
CALL and Hear the Rumble of an Organ as Never Before on our Wide Frequency Range Models, the best yet.
VORTEXION, Ltd., 182, The Broadway, Wimbledon, S.W.19. See our advertisement under New Mains Equipment. [3904]
COULPHONE AMPLIFIERS, Hutton, Preston.
18-20-Watt Amplifier, Gram-Mike fader, cadmium plated chassis; price £15. [4144]
TRADERS, write for our lists; all best makes equipment supplied.—Perseus Co., W.W., Burton-on-Trent. [4114]
PARTRIDGE P.A. Manual, free to trade. See "Partridge Transformers" under "New Mains Equipment." [3487]
HARMONY HOUSE SOUND SERVICE, Southport.—Beam power amplifiers, 14 watts output; £13/10 (subject); send for lists. [0546]
HARTLEY TURNER G.A.12.S Latest Amplifier, 14 watts, undistorted, brand new, any trial, cost £15; offers.—Clarke Radio, Alum Rock; Birmingham. [4117]
HARTLEY TURNER G.A.12.S Amplifier, 14 watt PK25 push pull output, with Hartley Turner 20 watt energised speaker, perfect order, 6 months' use; £14 or best offer.—Edwards, "Ladykirk," Newick. [4124]
AMPLIFIED Speech and Music for Fetes, sports meetings, etc., using our public address mobile equipments, also smaller equipments for dinners, dances, conferences, etc.—Harmony House Sound Service, Southport. [0548]

GALPINS ELECTRICAL STORES

75, LEE HIGH RD., LEWISHAM,
LONDON, S.E.13.

TERMS: CASH WITH ORDER OR C.O.D.
Telephone: Lee Green 5240.

EX-G.P.O. MAGNETIC RELAYS. Working Current 1 1/2 m/A. in new condition, Type B, 7/6. Post 6d.
ELECTRIC LIGHT CHECK METERS, Kilowatt Hour Type, for Sub-letting, Garages, etc. Guaranteed in good condition, 6/- each. Post 1/-.
WESTINGHOUSE RECTIFIERS. Output 500 volts 250 m/A., in perfect condition, 25/-.
MAINS TRANSFORMERS. By well-known makers. Input 200/250 volts, output 350/0/350 v. 120 m/A., 4 v. 4 a. C.T., 4 v. 2 amps., brand new, 8/11, post 9d.
T.C.C. ELECTROLYTIC CONDENSERS. 8 mf. 500 v. working, 1/6 each; 16 mf. 320 v. working, 1/9 each; 25 mf. 25 v. working, 1/- each.
LARGE TRANSFORMER. 175 volts input, 350 volts output at 15,000 watts., 20/-, C/F.
METAL CHASSIS. 4-valve, 1 1/2 x 8 1/2, 8d. each, post 6d.
QUARTZ MERCURY VAPOUR LAMP. 3,000 C.P., complete with Diagnostic Screen for 200/250 volt A.C. mains. Only had 4 hours' use. Cost £95; to clear, £35.
PERMANENT MAGNET MOVING COIL SPEAKERS by well-known makers, fitted volume tone control, magnificent reproduction, ideal for extension speaker, 8/6 each. Post free. Complete in walnut cabinet, 14/-, Post free.
MORSE KEY AND BUZZER SETS, complete, mounted on mahogany base, complete with sharp note buzzer, solid brass construction, high-grade long-wearing contacts, 5/- each. Post free.
ZENITH VITREOUS RESISTANCES, 3,000 ohms, 200 m/A., 2/-; 2,000 ohms, 100 m/A., 1/-; 20,000 ohms, 50 m/A., 1/6; 1,000 ohms, 200 m/A., 1/3; 120 ohms, 1/2 amp., 1/-, Post 3d.
EX-R.A.F. MARCONI R. VALVES, 6 v. Bright Emitter, suitable for small experimental transmitters, Morse practice, 1/- each.
MARK III. STAR CRYSTAL RECEIVER, complete in good condition, 35/-.
HOOVER CARPET SWEEPER, 200/250 volt Universal, as used in Hotels, in good condition, £4.
VISUAL WAVEMETERS, 300 to 550 metres, 5/- each.
WESTERN ELECTRIC MICROPHONES, highly sensitive, 2/6 each. Transformers to suit, 2/6 and 3/6.
HIGH-GRADE MICROPHONE TRANSFORMERS, various ratios, 3/6. Post free.
EX-R.A.F. MORSE KEYS, fully adjustable, a very robust job, 2/6 each. Post 6d.
BELLING ELECTRIC FIRES, 200/250 volts, 2 kilowatt type, 10/-, C/F.; 1 kW., 7/6 each, C/F.
X-RAY TUBES, new condition, with Tungsten Target, 15/-; with Platinum Target, 20/-, C/F. Packing free.
CHARGING RESISTANCES or Shunt Regulators. Stud, switcharm type, 12/6 each, to suit your requirements.
DOUBLE OUTPUT GENERATORS, outputs, 30 volts 15 amps. D.C., and 24 v. 15 amps. A.C., 1, P.H. at 100 cycles can also be used as a rotary converter D.C. to A.C., 50/-.
HAND-DRIVEN GENERATOR, double output, 800 v. at 100 m/A. and 6 v. at 4 amps., can be power driven if required or used as a Rotary Converter for H.T. output, price £2 10s.
C.A.V. AUTOMATIC CHARGING CUT-OUTS, suit any voltage, 7/6 each.
ISENTHAL VARIABLE RESISTANCE, to carry 10 to 15 amps., fitted 0 to 15 a/meter and Pilot Lamp, as new, 17/-, C/F.
LARGE MERCURY MOTOR-DRIVEN BREAKS, for 200/250 volt A.C. mains, 45/-, C/F.
ROTARY CONVERTORS, 220 volts D.C. input, 25 v. 6 amps. output D.C., 40/-; another 220 v. D.C. input with two outputs, either 20 volts at 60 amps. D.C. or 825 v. at 12 amps. D.C., 90/-; another, 100 volts D.C. input, 2,000 volts at 500 m/amps. output D.C., 70/-.
CHARGING OR LIGHTING DYNAMOS, all fully guaranteed, 200 volt 5 amp., 70/-; 50/75 v. 6 a., 45/-; 100 v. 10 a., 70/-; 12 v. 8 a., 17/6.
BATTERY AMPLIFIER, 2-valve, for microphone or gramophone pick-up, condition as new, 6/- each, less valves.
LARGE SUNRAY ARC LAMP. Self-adjusting, for 100/250 v. A.C. or D.C. mains, in perfect condition, £3 10s.
COFFEE GRINDERS, all complete and for 220 v., D.C. mains: one 1/2 h.p., 35/-; one 1/4 h.p., 45/-.
500 WATT MAINS DIMMER RESISTANCE, Slider-Type, 17/6 each.
WORKSHOP FLEX, V.I.R. and Braided, for 5, 10 or 15 amp., in 36-yard coils, 4/6 per coil. Post free.
MOTOR BLOWERS, 1/2 h.p. D.C. Blowers, 4in. inlet and outlet, 11/9 v. D.C., 35/-; 220 v. D.C., 45/-.
B.T.H. VARIABLE RESISTANCES, 250 ohms, 1 to 3 amps., 15/-, C/F.
COSSOR EX-R.A.F. 2-VOLT GENERAL PURPOSE VALVES, as new, 3 for 2/6. Western Electric 2 mf. Condensers, 9d. each. T.C.C. 2 mf. Condensers, 1/-.
Microphone Buttons, 9d. 20-30 H. Mains Chokes, 40-60 and 80 m/A., 1/-, 1/6, 2/6 each. 1,000 ohm Earphones, 1/3 each; 2/- per pair. 1,000 ohm Bobbins, 6d. per pair. Small Horseshoe Magnets, 3d. each. .0003 and .001 Variable Condensers, 1/- each. Ex-R.A.F. Remote Control Panels, useful for components, 1/- each. Ex-R.A.F. Cut-outs, 20 v. 3 a., with voltage regulator, 1/9 each. Belling 1 kW. Elements, 2/6. Bulgin Toggle Switches, 250 v. 1 a., 100 v. 3 a., 9d. each. G.P.O. Bell Boxes complete, Transformer, Bell, etc., 3/6 each. G.P.O. and Silvertown Galvanometers need slight repair, 2/6 each. Ex-R.A.F. One-Valve Receivers, less valve, 3/6. 2 kW Transformer, windings not known, 25/-.

USED SETS FOR SALE AND WANTED

EDDYSTONE

EDDYSTONE 1937 Six-valve A.C., S.W. locality too noisy; £10, or nearest.—Playden, 145, Chapter Rd., Cricklewood, London. [4130]

R.G.D.

NEW Unused Latest R.G.D. Table Model; price £10.—Wood, 2d, Davigdor Rd., Brighton. [4122]

NEW MAINS EQUIPMENT

V
V

VORTEXION Quality Transformers

VORTEXION Supply the B.B.C., G.P.O., L.P.T.B., I.C.I., Borough Councils, etc. Why not you?

ALL Fitted Screened Primaries, and tapped 200-250v. with centre tapped filaments, guaranteed one year.

W.W. Q.A., 425-0-425v. 120-160 m.a., 4v. 5-10a., 4v. 2.5a., 4v. 1-2a., 4v. 1-2a., super shrouded model; 32/-.

500-0-500v. 150 m.a., 4v. 4a., 4v. 2.5a., 4v. 2a., 4v. 2a., 4v. 2a., super shrouded model, 2.5% regulation, 35/-; open type, 32/-; 400 or 450v. same price.

350-0-350v. 120 m.a., 4v. 2-6a., 4v. 2-4a., 4v. 1a., 4v. 1a., super shrouded, 25/-; normal shrouded, 21/-; open type, 18/6.

350-0-350v. 75 m.a., 4v. 2-4a., 4v. 1-2a., shrouded, 18/-; open type, 16/-.

250-0-250v. 60 m.a., 4v. 2-4a., 4v. 1-2a., shrouded, 15/-; open type, 12/6.

AUTO Transformers, 100-120 to 200-240v.; 80 watts 11/-, 120 watts 14/6, 200 watts 21/-, 500 watts 37/6.

CHOKES—30h. 60 m.a., 7/6; 7-13h. 120 m.a., 12/6; 30h. 150 m.a., 15/-.

OUTPUT Transformers.—4-10 watt W.W. Q.A., 21/-; 20 watt super shrouded, 30/-.

VORTEXION, Ltd., 182, The Broadway, Wimbledon, London, S.W.19. (Telephone: Liberty 2814.) [3951]

ALL POWER

TRANSFORMERS, Ltd.—Transformers and chokes embodying all the best in design; no better value at any price; Radiolympia models; tapped and screened primaries, filaments centre tapped.

250-0-250v. 60 m.a., 4v. 1-2a., 4v. 2-4a., 12/6, post 7d.; extra filament, 4v. 1a., 12/6.

350-0-350v. 60 m.a., 4v. 2-3a., 4v. 2-4a., 15/-, post 8d.; extra filament, 4v. 1a., 16/-.

350-0-350v. 120 m.a., 4v. 2-3a., 4v. 4-6a., 4v. 1-2a., 19/-, post 1/-; extra filament, 20/-.

500-0-500v. 140 m.a., 4v. 2-4a., 4v. 4-6a., 4v. 2a., 4v. 2a., 29/6, post 1/-.

L.T. Charger, charging rate 1a., 2, 6, or 12-volt, employing metal rectifier L.T.S. 37/6, post 1/-.

WRITE for List; special quotations by return.

ALL POWER TRANSFORMERS, Ltd., 8a, Gladstone Rd., Wimbledon, S.W.19. Tel.: Liberty 3303. [3383]

PARTRIDGE Transformers, as supplied to B.B.C., Marconi's, G.E.C., Mullards, I.C.I., Tungsram, etc.

SPECIALS Despatched Within 48 Hours; all standard types from stock.

SPECIAL Quotations to Manufacturers for Lots of 6 Upwards, hand wound, individually tested, immediate delivery, rock bottom prices.

TELEVISION Transformers Insulated to 10,000v. A.C., expert knowledge of transmitting requirements (mains and modulation).

HIGH Fidelity (20 to 15,000 Cycles) Intervalve and Output Transformers a Speciality.

PARTRIDGE P.A. Manual Free to Trade Only; contents includes constructional amplifiers, notes on microphone, pre-amplifiers, lines, mixing impedance matching speakers, etc.

PARTRIDGE, N. B.Sc., A.M.I.E.E., King's Buildings, Dean Stanley St., London, S.W.1. Phone: Vic. 5035. [3717]

TANTALUM for A.C. Chargers, H.T. and L.T.—Blackwell's Metallurgical Works, Ltd., Garston, Liverpool. [3984]

MAINS EQUIPMENT

SECOND-HAND, CLEARANCE, SURPLUS, ETC.

MAINS Unit, containing transformer, chokes, rectifier, 5 condensers, fuses, all first quality, cost £6; bargain, 50/-—Iles, Billericay. [4132]

CABINETS

RADIOGRAM Cabinets, new designs, 30/- to £5/10; inspection invited or photos for selection sent on request.

TABLE Radio Cabinets, undrilled, 6/6 upwards.

SPEAKER Cabinets, 4/6 upwards.

MANUFACTURERS' Clearance.

BURGOYNE "Fury" Radiogram Cabinets (undrilled), 34x22x16 1/2; 49/6.

K.B. De Luxe Walnut Cabinets, undrilled, chromium plated edges and speaker grille, 25in. wide, 14 1/2in. high, 10 1/2in. deep, 18/6; Console model, 42in. high, 21 1/2in. wide, 11 1/2in. deep, 39/6.

HALCYON Radiogram Cabinets (Reconditioned), 33x23x19, 35/-.

H.L. SMITH and Co., Ltd., 287-9, Edgware Rd., London, W.2. Tel.: Pad. 5891. [0485]



1937 DEMONSTRATION TOURS OF VOIGT SPEAKERS have already commenced

TOUR No. 1 covered Cambridge, Norwich, Cleethorpes and Birmingham.

TOUR No. 2 covered Kettering, Derby, Bradford, Harrogate and Nottingham.

(* Lectures to Radio Societies.)

More Tours are being planned. We have already had new demonstration points offered at—

NEWBURY, TROWBRIDGE, BRISTOL, LIVERPOOL, SCUNTHORPE, EDINBURGH, SKELMORLIE.

Intermediate points are particularly desired.

As you know, the Tours are to be point-to-point Tours with demonstrations preferably about 30 miles apart, the conditions being that in exchange for an evening's entertainment our host permits us to invite other interested visitors to the demonstration and accommodates our engineer for the night. The average number of visitors is 6.

This may be your opportunity to hear a Voigt Speaker in your own district. If interested, please write stating whether you wish to be VISITOR or HOST. If the latter, please give dimensions of demonstration room and distance to nearest garage. We welcome comparison tests with other speakers.



VOIGT PATENTS LTD.

THE COURTS, SILVERDALE, SYDENHAM, LONDON, S.E.26
Telephone: Sydenham 6666
Regd. Office: 22, Castle Street, E.C.1

ENGINEERING OPPORTUNITIES

Free!

268 PAGES

This unique Handbook shows the easy way to secure

A.M.I.G.E.,
A.M.I. Mech E., A.M.I.E.E.,
A.M.I.A.E., A.M.I.W.T.,
A.M.I.R.E., and similar qualifications.

WE GUARANTEE—"NO PASS—NO FEE." Details are given of over 150 Diploma Courses in all Branches of Civil, Mech., Elec., Motor, Aero, Radio and Television Engineering, Building, Government Employment, etc. Write for this enlightening Handbook to-day

FREE and post free.

British Institute of Engineering Technology
387, Shakespeare House, 17, 18, 19, Sturford Pl., W.1

FRONT PAGE NEWS



Our announcement on the cover styles us as manufacturers of high grade apparatus. Here is an example:—

Our latest specially designed Public Address Amplifier 14 watts undistorted output
PRICE £22.10.0.

In your own interests it will pay you to have further details. May we supply them?

SOUND SALES
MARLBOROUGH RD., UPPER HOLLOWAY LONDON, N.19. (Contractors to the G.P.O., etc.)
LIMITED. Tel.: Archway 1661/2/3

Cried Smithson, "What's this that I've got, Is it Mars or Australia, or what? But his pal merely said, You've got crackle, instead Of the Fluxite your wiring did not!"

See that FLUXITE is always by you—in the house—garage—workshop—wherever speedy soldering is needed. Used for 30 years in Government works and by leading engineers and manufacturers. Of Ironmongers—in tins, 4d., 8d., 1/4 and 2/8.

Ask to see the FLUXITE SMALL-SPACE SOLDERING SET—compact but substantial—Complete with full instructions, 7/6.

Write for Free Book on the art of "SOFT" SOLDERING—and ask for leaflet on CASE-HARDENING STEEL and TEMPERING TOOLS with FLUXITE.

TO CYCLISTS! Your wheels will NOT keep round and true unless the spokes are tied with fine wire at the crossings AND SOLDERED. This makes a much stronger wheel. It's simple—with FLUXITE—but IMPORTANT

THE FLUXITE GUN

is always ready to put Fluxite on the soldering job instantly. A little pressure places the right quantity on the right spot and one charging lasts for ages.
Price 1/6



ALL MECHANICS WILL HAVE

FLUXITE

IT SIMPLIFIES ALL SOLDERING

FLUXITE LTD., Dept. W.W., DRAGON WORKS, BERMONDSEY ST., S.E.1

VALVES

NOTHING Better Available. Six months' guarantee. Complete range of battery, A.C. mains, rectifiers, always in stock, 2 volt det., H.F., L.F., 2/3; Power, 2/9; screen grid pentode, H.F. pentode, 5/-; American types, six months' guarantee, 5/6 each, Nos. 18, 24A, 35, 42, 43, 45, 47, 56, 57, 58, 75, 77, 78, 80, 2A5, 2A6, 2A7, 6A7, 2B7, 6B7, 6C6, 6D6, 25Z5, 25Y5.—Write for other prices to Dulci Electrical Co., Devonshire Works, Duke's Av., Chiswick, London, W.4. [0501]

METERS, ETC.

PRECISION Instruments. £££ cheaper than anywhere else; send for lists.—Kay, 1, Old Church Lane, N.W.9. [4125]

NEW COMPONENTS

MICROPHONES.—Reisz or Lapel parts.—A. Hinderlich, 2, Bridge Rd., London, N.W.10. [4008]

COMPONENTS

SECOND-HAND, CLEARANCE, SURPLUS, ETC.

RADIO CLEARANCE.

63, High Holborn, W.C.1. Holborn 4631.

ALL Sets Previously Advertised in Late Issues Still Available. As we go to press the following sets have arrived:

BUSH 4-valve A.C.23 3-valve Plus Rectifier Modern Mains Superhet. Receiver, a really magnificent job, in handsome dark finish walnut cabinet; to clear, £4/15. BUSH S.B.4 4-valve Modern Battery superhet., similar in performance and appearance to the mains receiver; £4/12/6.

LISSEN 3-valve Straight Receiver, fitted in a really handsome light brown bakelite cabinet, large P.M. moving coil speaker, 3 Ever Ready valves, etc., aerial tested; 27/6.

LISSEN 3-valve Ditto, but fitted in dark walnut finish cabinet; 25/-.

LISSEN Band Spread 3 Short Wave Receiver; a few only built, to clear at 25/-; slightly soiled.

LISSEN 3-valve Band Spread Short Wave Kit, a very few to clear at 27/6.

HERE is Your Opportunity to Obtain an Ideal and Efficient Short Wave Battery Receiver at a Very Low Price.

REMEMBER, the above are all complete with ring valves.

ENQUIRIES, 1/4d. stamp if reply expected.

HOURS of Business, 9 a.m. to 7 p.m.; Saturdays 9 a.m. to 1 p.m.

ALL Orders Value 5/- or over Post Free; orders under 5/- must be accompanied by a reasonable amount for postage.

C.O.D. Orders Under 5/- Cannot be Accepted.

ORDERS from Ireland and Special Parts of Scotland are Subject to Certain Increased Rates, and customers are advised to apply for details of postage before ordering.

RADIO CLEARANCE, 63, High Holborn, W.C.1. Holborn 4631. [4108]

VAUXHALL

VAUXHALL.—Polar Midget 3-gang condenser, straight or superhet, 8/9; Polar full vision, horizontal or Arcuate dial and drives, 5/-.

VAUXHALL.—J.B. drives with station-named scale, latest type, complete, 5/6; T.C.C. tubular, 0.25 mid., 9d.

VAUXHALL.—Flat, sheet aluminium, hard rolled, 18 gauge, 12in. x 12in., 3/-; 18x18, 5/6; other sizes pro rata.

VAUXHALL.—Hivac, Tungstam valves, full range; full discounts allowed from new prices.

VAUXHALL.—Polar station-named scales, for horizontal dials, latest settings; 1/9 each.

VAUXHALL.—Polar 2-gang condenser, 6/8; Colvern twin-gang iron cored coils, on base with switch, 20/-.

VAUXHALL.—Colvern coils, G1, G2, G3, or G1, G2, and G8, superhet type, 30/-; Colpaks, £2/4; Polar drives, 5/-.

VAUXHALL.—Iron-cored coils, 3-gang, on base, with circuits, 17/-; B.T.H. Minor pick-ups, 13/3.

VAUXHALL.—All-wave tuning pack, 16.5 to 52 metres, medium and long waves; 87/6.

VAUXHALL.—Heavy low frequency smoothing choke, 10 henrys, 120 m.a., fully shrouded; 11/6.

VAUXHALL.—Set manufacturers' surplus skeleton type Westinghouse rectifiers, H.T.8 8/6; H.T.9, 9/-; H.T.10, 10/-; fixing brackets free.

VAUXHALL.—T.C.C. electrolytic condensers, 8 mfd. and 4 mfd., 550 volt, 3/-; 500 volt, 2/6; 450 volt, 2/5.

VAUXHALL.—T.C.C. condensers, tubular, non-inductive, 0.1, 6d.; 50 mfd., 50v. working, 1/6; 50 mfd., 12v., 1/3; 0.05, 6d.; 0.002, 0.0002, 0.001, 0.0001, 4d. each.

VAUXHALL.—T.C.C. mica, 0.002, 2,000 volt test, 1/-; 0.0001, 4d.; 0.001, 1/-; 1 mfd. Mansbridge, 1/3.

VAUXHALL.—Resistances by well-known manufacturers, 1-watt type, 6d. each; all values.

VAUXHALL.—Centre tapped iron cored I.F. transformers, bases, terminals, 110 k/c; 6/6, guaranteed.

VAUXHALL.—Volume controls, Eric, Colvern, Centralab, 2/-; with switch, 3/-; all values, from 2,000 to 2 meg.

VAUXHALL.—Pushback wire, four colours, 6 yds. 6d.; 6B.A. screws or nuts, 4d. dozen.

VAUXHALL.—T.C.C. 200 mfd. 10v. dry, 2/6; 8 mfd., wet, 450v. working, 3/3; Westectors, WX6, 4/-.

VAUXHALL.—Colaro A.C. electric motors, boxed, 25/6; similar model, complete pick-up and volume control, 41/6; Universal motors, 47/6.

VAUXHALL.—Clix valve holders, terminals, 7-pin, 9d.; 5-pin, 7d.; 9-pin, ordinary, 9d.; baseboard, 4-5-pin, 6d.

VAUXHALL.—Post paid 2/6 or over, or cash on delivery 5/- minimum.

VAUXHALL UTILITIES, 163a, Strand, W.C.2, over Denny's, the Booksellers, Temple Bar 9338. Send postcard for lists free. [4135]

ELECTRADIX BARGAINS



HOME RECORDING

at low cost. Electric Felgh set has ball bearing centre gear box and geared traverse rod. Price with Tracking Gear, Pick-up and Tone Arm with diamond 37/6

For experimenters requiring gear only, less Pick-up and Tone Arm, this is 21/6. FREE GRID'S Secret Ray protectors for Television gazers and burglars. Infalible, imperceptible and cheap. Complete kit with photo cell, 45/-.

CABLE AND WIRE. Copper prices are rising steeply, so send us your orders before cost is too dear for you. MEGGERS AND OHM-METERS, 1,000 ohms. to 20 megs., from 25 10s. SERVICE TESTER, DC/AC for any circuit, any valves, moving coil meter window circuit switch, leak case. A ten-guinea set for 25 17s. 6d. Guaranteed.

Heyt CZ mov. coil milliammeters, 25-0-25 m/a, 10". Weston, 0 to 30 m/a mov. coil milliammeters, 17/6. 100 m.a., 17/6.

TELEPHONES for HOUSE, OFFICE, GARAGE, and Field Sports. Table Wall and Waterproof Portable, from 10/-.

Headphones for short-wave radio, etc., 2-9 pair. Telephone wire still cheap.

VALVES, 6v. Power, Standard Cables, 2/6. Midget Iv. Weco, 4/-.

Transmit. AT40 Cossor, 4/6. Ultra-short V24 and Q, 8/6.

GABINETS with screened panel, fitted variable and microdenisers, terminal panel and coil base for Battery 8/W Kit, 8/6.

MORSE KEYS, Genuine Service Types for efficient work. Cheap.

PARCELS of experimental odd coils, magnets, wire, chokes, condensers, switches, terminals, etc., post free: 10 lbs., 7/-; 1 lb., 5/-.

1,000 other Bargains in New Sale List "W"

ELECTRADIX RADIOS

218, Upper Thames Street, London, E.C.4. Phone: Central 4611

OSTAR-GANZ
UNIVERSAL HIGH VOLTAGE RADIO LTD.
CORONATION OFFER
To enable customers to take advantage of the High Voltage Valves for the Coronation, we allow a special discount of 20% up to 15th May on all valve orders, all-wave Universal kits for receivers, radiograms, transmitters and AMPLIFIERS WITH MICROPHONES; also on our regular conversion prices.
EUGEN J. FORBAT, 28-29, Southampton St., Strand, London, W.C.2. Telephone Bar 8608-4985.

HYVOLTSTAR
high-class hand-made Universal All-wave Receivers are specially suited to receive broadcasts from any part of the World. Special part exchange offer for the Coronation of 20% on any type of receiver, against our chassis receivers and radiograms from 4 to 10 valves. Favourable H.P. Terms can also be allowed.
Ask for our catalogue, also details of our unique battery all-mains receiver.
UNIVERSAL HIGH VOLTAGE RADIO LTD., 28-29, Southampton Street, Strand, W.C.2. Telephone: TEMple Bar 4985 & 8608.

HIRE PURCHASE
We can supply any Radio and Electrical Apparatus on HIRE PURCHASE having a value of over £3 at convenient terms, including Midwest, Spartan, Challenger, Armstrong, Scientific Supplies and other receivers. Spartan Refrigerators. "Easy" Washing Machines, etc. etc.
CHAS. F. WARD, 46, Farringdon Street, LONDON, E.C.4. Tel.: Holborn 9703.

TANNOY
THE SOUND PEOPLE
FOR GUY & FOUNTAIN LTD., CANTERBURY GROVE, WEST NORWOOD, LONDON, S.E.27. Phone: Bar 122 (6 lines)
ALL SOUND AMPLIFYING EQUIPMENT

MOTOR CYCLE
The Motor Cyclist's Newspaper
EVERY THURSDAY—3d.
Publishers: ILIFFE & SONS LTD., Dorset House, Stamford Street, London, S.E.1. w.w.15

REPAIRS AND SERVICE

REPAIRS, rewinds, and construction, any size transformers, chokes, etc., to trade.—Felelectric, Garden St., Sheffield, 1. [3915]

FOR Unusually Good Rewinding of Transformers, chokes, speakers, etc.; trade only.—Gardners Radio, Ltd., West Southbourne, Bournemouth. [0551]

OUR Technical Department is at your Service.—Air King Radio, 115 Shaftesbury Av., Cambridge Circus, W.C.2. Phone: Temple Bar 4875 (2 lines). [3963]

LOUD Speaker Repairs, British, American, etc.; any make transformer coils rewound; alterations.—Sinclair Speakers, Alma Grove, Copenhagen St., N.1. [4030]

NATIONAL RADIO AND TELEVISION SERVICE Co.—Leading Service Engineers and Car Radio Experts, 155-157, Great Portland St., W.1. Phone: Langham 3477. [3911]

POULTNEY and PURVIS, British and American Service, trade or private; "W.W." sets a speciality; free collection, estimates.—147, Pitshanger Lane, Ealing, W.5. Perivale 3765. [3976]

GUARANTEED Repairs.—Any transformers, choke, motor, armature, converter, dynamo, etc.; keenest prices, immediate quotation; prompt, dependable service.—See below.

L.T.P. (LONDON TRANSFORMER PRODUCTS, Ltd.), Willesden, N.W.10. Wil. 3568 and 7743. [3470]

MAINS Transformer Service.—Repairs, rewinds, or constructions to specification of any type; competitive prices and prompt service.—Sturdy Electric Co., Dighton, Newcastle-on-Tyne. [0516]

F. E. GODFREY, A.M.I.R.E., qualified to build, repair and convert "Wireless World" sets, etc.; 25 years' experience: prompt service guaranteed.—30, Kemplay Rd., Hampstead. Hampstead 1104. [3509]

TRADE Service.—British and American receivers serviced at reasonable cost; estimates free; work guaranteed three months; American valves.—Majestic Service Co., 22-28, King St. West, Manchester, 3. Phone: Blackfriars 4951. [0544]

ZETAVOX Zenith, repairs, conversions; specialists in installation and repairs car radio, trade service, public address, coil winding, sets designed; estimates free.—Radio Service and Television Co., 68a, Colebrooke Row, Islington. Clerk. 1157. [4121]

ALL British or American Sets Repaired or Modernised by Qualified Engineers; satisfied customers throughout the world are your guarantee; send to-day for free estimate; free collection 10 miles radius of London.—Scott-Sessions and Co., Exchange Works, Dukes Avenue, Muswell Hill, London, N.10. Phone: Tudor 4101. [0552]

REPAIRS to Moving Coil Speakers a Speciality; cones and coils fitted, fields altered; prices, including eliminators, quoted, loud speakers, 4r.; L.F. and output transformers, 4r., post free; guaranteed satisfaction; trade invited; estimates free; prompt service.—Loud-Speaker Repair Works, 6, Balham Grove, London, Battersea [0394]

EXTENDED PAYMENTS

L **LONDON RADIO SUPPLY Co.** (Established 1925) supply on convenient terms, components, accessories and sets, any make, 10% down, balance over 12 months; send for list of requirements.—11, Oat Lane, London, E.C.2. [0337]

HIRE-PURCHASE—Prompt delivery of any radio apparatus on convenient terms.
WARD 46, Harrington St., London, E.C.4. Tel.: Holborn 9703. [0539]

ELECTRIC CLOCKS

SMITHS and Ferranti Electric Clocks, Waltham and Russell watches and clocks; traders' enquiries invited.—Leonard Heys, 36, Henry St., Blackpool. [0526]

EXCHANGE

COSMIC RADIO SERVICES, Ltd., 23, Water St., Liverpool, accept quality mains equipment, meters, components, etc., in part exchange. Meters purchased. [2490]

I **BUY**, sell, exchange good quality receivers, accessories, components; H.P. facilities; promptness, efficiency.—Bostock, 1, Westbourne Terrace, S.E.23. Forest Hill 2236. [0529]

PATENT AND TRADE MARK AGENTS

GEE and Co. (H. T. P. Gee, Mem. R.S.G.B., A.M.I.R.E., Estab 1905), 51-52, Chancery Lane, London, W.C.2 (2 doors from Government Patent Office). Holborn 4547 (2 lines). Handbook free. [0001]

TUITION

RADIO Training.—Marine, aircraft, broadcast; prospectus free.—Hull Municipal Technical College. [0523]

PRACTICAL Radio and Television, private or postal training; particulars free.—R.T.L., 39-47, Earl's Court Rd., W.8. Western 6917. [3759]

A Complete Range **MINIATURE METERS**

These compact little magnetic instruments have bezels finished in dead black with matt silvered dials fitted with unbreakable glass. Whilst the prices are low, the accuracy is maintained almost indefinitely at $\pm 5\%$. Being highly damped yet extremely sensitive they may be used with confidence in all D.C. circuits where the moving coil type is not actually necessary.

MILLIAMMETERS.
List No. Scale. Ohms.
D.M.14 .. 0-8MA 2,000
Price 8/6 each.
D.M.15 .. 0-15MA 1,000
D.M.16 .. 0-20MA 500
D.M.17 .. 0-30MA 225
D.M.18 .. 0-40MA 150
D.M.19 .. 0-50MA 120
D.M.20 .. 0-100MA 30
D.M.21 .. 0-200MA 15
Price 7/6 each.

VOLTMETERS.
List No. Scale. MA.
D.M.1 .. 0-5v 75
D.M.2 .. 0-8v 20
Price 7/6 each.

AMMETERS.
List No. Scale. V. drop.
D.M.4 .. 0-0.5A 0.5v
D.M.5 .. 0-1A 0.5v
D.M.6 .. 0-3A 0.5v
D.M.7 .. 0-8A 0.5v
Price 7/6 each.

Central Zero Ammeters are made to order in quantities. Price 7/6 each retail.

Send now for 116-page Catalogue No. 156W. Kindly enclose 3d. postage.
A. F. BULGIN & CO., LTD., Abbey Road, Barking, Essex.

BULGIN
In a Class alone.

For really high-grade mains transformers and chokes—it's best to go to Savage!

★From our standard lists or to your specifications. We will gladly send you lists on request or quote to your particular requirements.

W. BRYAN SAVAGE LTD.
WESTMORELAND ROAD, LONDON, N.W.9
PHONE: COLINDALE 7131 (3 LINES)

PRISM RADIOGRAMS AND PUBLIC ADDRESS EQUIPMENT

PRISM MANUFACTURING CO. CALIFORNIA WORKS. BELMONT, SURREY. Phone: Sutton 5361/2.

WANTED

WANTED, record changer, D.C. preferred.—Write Box 1302, c/o The Wireless World. [4118]

SPOT Cash for Modern Sets and Components.—Economic Radio, 96-98, South Lambeth Rd., S.W.8. [3942]

CONVERTOR Wanted. 150 Watts, 240 D.C. to A.C.—Wensell, 648, Seven Sisters Rd., London, N.15. [4134]

BATTERY Portable, also A.C. set or radiogram, milliammeter, voltmeter, loud-speaker.—Blackmore, Dale Rd., Spondon. [4133]

WANTED, E.D.C. Rotary converter, 220 volts D.C. to 220-230 volts A.C., 250-300 Watts, filter and cabinet, complete.—Kilpatrick, Diamond, Londonderry. [4138]

SITUATIONS VACANT

RADIO Service Engineer Required for S.W. London for Spare Time Work, mainly evening.—Phone Str. 4193 for appointment. [4123]

ELECTRICAL Engineer Wanted; used to public address work, installation and maintenance.—Apply Fortiphone, Ltd., 33, Copeland Rd., Peckham, S.E.15 (behind Holdron's). [4139]

WIRELESS—All students placed; Marconi approved school; G.P.O. licence; fees after training; boarders accepted.—Dept. W/W., Wireless School, 21, Manor Gardens, Holloway, N.7. [4085]

RADIO Engineer for Supervision of Electrical Work in Assembly Department of Large Mass Production factory; S.W. London.—Write, stating age, experience and salary required, to Box 1316, c/o The Wireless World. [4137]

WIRELESS Operators and Engineers Urgently Required.—Train at Britain's leading colleges; fee after appointment; boarders; prospectus free.—The Wireless College, Colwyn Bay, or The Wireless College, Calmore, Southampton. [0541]

RADIO Transmission Engineer Required by Large Firm in the Midlands, with experience in the design of modern battery and mains operated short-wave transmitters from five metres upwards (laboratory experience essential), state experience, age and salary required.—Box 1303, c/o The Wireless World. [4119]

SITUATIONS WANTED

YOUTH, 17 years, desires employment, progressive capacity, with serviceman, wide knowledge, no experience.—69, Edridge Rd., Croydon. [4129]

DICTIONARY of WIRELESS TECHNICAL TERMS

Compiled by S. O. PEARSON, B.Sc., A.M.I.E.E. and issued in conjunction with "THE WIRELESS WORLD"

Second Edition. Completely revised and brought up to date

This handy volume is very much more than a Dictionary. It not only takes the technical terms of wireless and explains their meaning, but in doing so it concentrates into a small space a large amount of information on wireless subjects. It becomes, in fact, a compendium of wireless knowledge, and an invaluable handbook for all who are interested in wireless transmission and reception. Diagrams and illustrations are freely interspersed throughout the book to amplify the explanations of the text.

272 pp., bound in cloth boards Size 5 by 3 inches

Price 2/- net. By post 2/2

From all leading booksellers or direct from Publishers.

ILIFFE & SONS LTD. Dorset House, Stamford Street, London, S.E.1 W.W.48

SECOND EDITION

—THOROUGHLY REVISED

WIRELESS SERVICING MANUALBy **W. T. COCKING***(of "The Wireless World")*

The first complete book of reference of its kind. A reliable practical guide for amateur and professional.

The demand for this book was so great that the first edition was sold out in the short space of a very few months. A second edition containing additional material is now on sale.

The "Wireless Servicing Manual" deals fully with Testing Apparatus and explains the methods of locating and curing faults in receiving equipment.

Ganging, Automatic Volume control, Instability, Distortion, Mains Hum, Whistles and Local Interference are all separately treated.

The new edition contains much additional information on short-wave receivers, and on methods of operating extension loud speakers, the reference material including base-connections for British, Continental and American Valves, and the various colour codes for components has been extended and brought up to date.

BOUND IN CLOTH BOARDS

SIZE 7½ ins. x 5 ins.

231 PAGES

PRICE 5/- net. By post 5/4

Issued in conjunction with "THE WIRELESS WORLD" and Published by the Proprietors:—

ILIFFE & SONS LTD., DORSET HOUSE, STAMFORD STREET, LONDON, S.E.1

W.W. 20

**FOUNDATIONS
of WIRELESS**

*A Book of
First Principles
for the
Wireless
Enthusiast*

PRICE 4/6 NET

By Post 4/11

Issued in conjunction with
"THE WIRELESS WORLD"
and published by the Proprietors—

By **A. L. M. SOWERBY, M.Sc.**

An Elementary Text Book on Wireless Receivers

"Foundations of Wireless," based on a series of articles which appeared in "The Wireless World," covers the whole field of wireless from the simplest electrical phenomena to the construction of a modern set, and all the vital points in receiver-design are treated in full detail. Chapters are devoted to direct and alternating currents; typical circuits; the properties of inductance and capacity; the nature of high frequency currents; the tuned circuit; and amplification by the valve.

Eleven of the eighteen chapters of the book deal with the discussion of receivers in which the whole process of design is reviewed stage by stage to the finished article.

Special attention is paid to the important subject of tuned circuits and band-pass filters, on the correct design of which the performance of every type of set ultimately depends. Moreover the process of detection, so often imperfectly understood, is clearly explained.

ILIFFE & SONS LTD., DORSET HOUSE, STAMFORD STREET, LONDON, S.E.1

Mention of "The Wireless World," when writing to advertisers, will ensure prompt attention.

INDEX TO ADVERTISEMENTS

Armstrong Mfg. Co.	PAGE	Forbat, Eugene J.	PAGE	Premier Supply Stores	PAGE
Automatic Coil Winder Co., Ltd.		Galpins	4	Prism Manufacturing Co.	8
Bakers Selhurst Radio		Gardners Radio, Ltd.		Radio Development Co.	10
Belling-Lee, Ltd.	3	Goodman's Industries, Ltd.	10	Radiographic, Ltd.	10
Birmingham Radiomart G5N1	7	Gramplan Reproducers, Ltd.	10	Savage, W. Bryan	8
British Institute of Engineering Technology	4	Hartley Turner Radio, Ltd.	2	Sound Sales, Ltd.	Front Cover, 6
British Insulated Cables, Ltd.		Haynes Radio	Front Cover	Stern, S.	
British Pix		Imhof, Alfred, Ltd.		Tannoy Products	6
British Rola Co., Ltd.	Edit. 339	Institute of Wireless Technology		Telegraph Condenser Co.	Edit. 337
British Sound Recording		Lectro Linx		Tungram Electric Lamp Works (Great Britain), Ltd.	
British Thomson-Houston Co., Ltd.	5	Linguaphone, Ltd.		Universal Radio Distributors, Ltd.	
Bulgin, A. S., & Co., Ltd.	8	Marconi's W. T. Co., Ltd.		Voigt Patents, Ltd.	4
C.A.V.		McCarthy Radio, Ltd.	Front Cover, Edit. 335	Vortexion, Ltd.	
Cossor, A.C., Ltd.	Inside Back Cover	Midwest Radio, Ltd.	10	Ward, C. F.	6
"Drydex"		M.P.R. Electrical Co.		Waverley Book Co., Ltd.	
Dubilier Condenser Co. (1925), Ltd.	Front Cover, Inside Front Cover	Musikon, Ltd.		Westinghouse Brake & Signal Co., Ltd.	
Ediswan, Ltd.	Back Cover	Parmeko, Ltd.	1	Wharfedale Wireless	10
Electradix Radios	6	Peto Scott, Ltd.		Wingrove & Rogers, Ltd.	
Exide, Ltd.		Pitman, Sir Isaac, & Sons, Ltd.	5	Wright & Weare, Ltd.	10
Fluxite	6	Players Cigarettes			

WHARFEDALE EXTENSION SPEAKER SERVICE

PERFECT MATCHING OF CABINET TO YOUR FURNITURE

PERFECT MATCHING OF SPEAKER TO YOUR SET



De Luxe Cabinet fitted with well-known Golden Chassis. Universal 95/-. Less Transformer, 82/6. Other cabinet models from 30/- Univ.

The wide range includes cabinets in Walnut, Oak or Mahogany. Also available unpolished, as supplied to Mr. F. . . ., whose letter is reproduced alongside.

Wharfedale Extension Speakers are fitted with TRUQUAL Compensated Volume Controls as supplied for use on Voigt Speaker installation at the British Empire Society Building.

Ask your radio dealer to demonstrate Wharfedale Speakers or send for Illustrated Catalogue.

WHARFEDALE WIRELESS WORKS, 62, LEEDS ROAD, BRADFORD, YORKS.

N. Wembley, Middlesex.
Feb. 23rd, 1937.

Dear Sirs,
I have now received the De Luxe Cabinet which you were good enough to send me. It has already been polished and is really a beautiful piece of work. I am as pleased with it as with the Golden Chassis and that is saying a great deal.
I would like again to thank you very much indeed for the trouble you have taken in this matter.

Yours faithfully,
J. F. F.

INSIST ON
WHARFEDALE
FOR SERVICE
AND QUALITY

FREE ART CATALOGUE DEMONSTRATIONS

40 pages, fully illustrated, giving particulars of Midwest 11, 14, 16, and 18 valve models. at our showrooms Mondays to Saturdays from 9 a.m. to 8 p.m. (except Tuesdays, 9 a.m. to 6 p.m.)

1937 MIDWEST



Magnificent alike in its conception, design and performance, this the latest Midwest Model X-18 High Fidelity Receiver brings the world to your fire-side. With its 6 TUNING RANGES it gets "Everything on the Air." Its distinctive features in circuit design are not just "talking points," as a comparison will prove, but basic advantages which will assuredly appeal to "Wireless World" readers and all who appreciate Studio or Concert Hall quality of performance in the home.

MIDWEST RADIO Ltd.
Showrooms and Factory:
18, Old Town, Clapham, London, S.W.4.
*Phone: MACaulay 5305.

THE ONLY ALL-WAVE RECEIVER COVERING 4 1/2 to 2,400 METRES
Available in Chassis form complete with matched valves and 12" speaker or in Console Cabinet.

SECOND EDITION — Completely Revised

RADIO DATA CHARTS A SERIES OF ABACS

Providing most of the essential Data required in receiver design

By R. T. BEATTY, M.A., B.E., D.Sc.

PRICE 4/6 net BY POST 4/10

From all leading booksellers, or direct from the Publishers. Published from the offices of "THE WIRELESS WORLD," DORSET HOUSE, STAMFORD STREET, LONDON, S.E.1 W.W.93

WEARITE ALL-WAVE OSCILLATOR UNIT

Covers all wavelengths from 15 M. to 3,000 M. in 7 ranges (harmonics not used).

MODULATION. May be switched off and external modulation used when required.

SHIELDING. Minimum leakage, no appreciable energy reaches the set.

STABILITY. Calibration permanent for all variables.

Price **£7.15.0**

Free booklet on returning this announcement to:

WRIGHT & WEAIRE, LTD.,

740, High Road, Tottenham, LONDON, N.17.

DON'T BELIEVE US!

... CHECK UP WITH ANY OF OUR 4,783 SATISFIED CLIENTS.

TRANSMITTING AND RECEIVING GEAR, VALVES, ELECTRICAL EQUIPMENT, HALL-CRAFTERS, VACUUM CLEANERS, WASHING MACHINES, ETC.

RADIOGRAPHIC LTD.
66, OSBORNE STREET,
GLASGOW, C.1.

P.A. at its Best
GRAMPIAN
PUBLIC ADDRESS EQUIPMENT
GRAMPIAN REPRODUCERS LTD.
Kew Gardens Surrey

The Autocar
The Leading Motoring Paper
EVERY FRIDAY 4d. W.W.16

TRADE & TECHNICAL Journals

*Influential
and
authoritative*

FOR TRADE DEVELOPMENT AND PROGRESS...

FOR FACTS OF PRODUCTION AND DISTRIBUTION.

FOR THE VERY LATEST NEWS AND INFORMATION

FOR AN INDEX TO GOODS USED AND SOLD.....

If you are seeking new markets, or desire to get first-hand information about a trade or industry, you cannot go to a surer or more authoritative source than the trade and technical journals serving it. The address of any paper in this list will be furnished on request.

Amateur Photographer and Cinematographer.
Architects' Journal.
Architectural Review.
Autocar.
Automobile Engineer, incorporating Motor Body Building.
Boxmakers' Journal & Packaging Review.
Brewers' Journal.
British Baker.
British Engineers' Export Journal.
British Journal of Photography.
British Printer.
Bus & Coach.
Chemist & Druggist.
Cigar & Tobacco World.
Confectioners' Union & Ice Cream & Soda Fountain Journal.

Drapers' Record.
Dyer, Textile Printer, Bleacher & Finisher.
Electrical Engineer.
Electrical Review.
Electrical Times.
Electrical Trading & Electricity.
Engineer.
Engineering.
Export Trader.
Flight.
Footwear Organiser.
Furnishing Trades' Organiser.
Grocer & Oil Trade Review.
Grocers' Gazette & Provision Trades' News.
Grocery & Branch Store Management.
Hotel & Catering Management.

Confectionery Journal.
Contractors' Record & Municipal Engineering.
Dairyman.
Drapers' Organiser.

India Rubber Journal.
Ironmonger.
Journal of Decorative Art.
Laundry (The Power).
Laundry Record & Dyeing & Cleaning Trades' Journal.
Licensing World & Licensed Trade Review.
Locomotive, Railway Carriage & Wagon Review.
Machinery.
Meat Trades' Journal.
Mechanical World & Engineering Record.
Men's Wear.
Mining Journal, Railway & Commercial Gazette.
Model Engineer & Practical Electrician.
Modern Transport.
Motor Cycle.
Motor Cycle & Cycle Trader.
Motor News.
Motor Trader.
Motor Transport.
Motor World & Industrial Vehicle Review.
Nursing Mirror.
Oil & Colour Trades Journal.

Outfitter.
Overseas Engineer.
Packing Gazette.
Photographic Dealer.
Plumbing Trade Journal.
Pottery Gazette & Glass Trade Review.
Poultry.
Printers', etc., Sales & Wants Advertiser.
Silk Journal & Rayon World.
Specification.
Statist.
Style for Men.
Textile Manufacturer.
Textile Recorder.
Tobacco Trade Review.
Waste Trade World.
Watchmaker & Jeweller, Silversmith & Optician.
Wine & Spirit Trade Review.
Wireless & Gramophone Trader.
Wireless Engineer.
Wireless Retailer & Broadcaster.
Wireless World.
Yachting World & Motor Boating Journal.

Official Handbook, giving particulars of over 500 papers, post free 1/-

**PERIODICAL, TRADE PRESS AND WEEKLY
NEWSPAPER PROPRIETORS' ASSOCIATION, LTD.**

Telephone:
Central 2441

6, Bouverie Street, London, E.C.4

Telegrams:
Weneppa, Fleet, London

TELEVISION DEVELOPMENTS

A NEW LARGE DIAMETER TUBE FOR TELEVISION REPRODUCTION



**TYPE 12H
TUBE**

The Ediswan Type 12H tube has a screen diameter of 12" giving a television picture 10" x 7½" without distortion.

The screen is of special material giving a close approximation to a black-and-white picture.

Specification:

Indirectly heated high vacuum tube.
 Heater Volts - - - 2.0
 3rd Anode Volts - - - 6000
 2nd Anode Volts - - - 1200
 1st Anode Volts - - - 150-400
 Sensitivity (mm./V.) - - - 950/V*

*V = anode volts

List Price £15.15.0

We also supply
 HIGH VACUUM RECTIFIERS
 GAS-FILLED RELAYS
 MERCURY VAPOUR RELAYS
 for Television Scanning
 circuits.

ENTIRELY BRITISH MADE

EDISWAN RADIO VALVES

THE EDISON SWAN ELECTRIC CO. LTD.  155 CHARING CROSS RD., LONDON, W.C.2

R.E.299

USED BY ALL GOVERNMENT DEPARTMENTS

The Wireless World

4^D



THE PRACTICAL RADIO & TELEVISION JOURNAL

Friday, April 9th, 1937.

Entirely New Range

1937 RK SPEAKERS



THE MINOR R.K. SPEAKER
(Cabinet Model)
Price (Cat. No. 70772)
£2. 18. 6

FLARE-SHAPED and variable density cones ensuring even response over a wide frequency range. Positive centring of the self-rigid coil former, eliminating fouling of the walls of the air gap. Improved metals for the construction of the field magnets, giving powerful, concentrated fields. These are some of the improvements embodied in the new R.K. Speakers which still further enhance the reputation gained by those pioneer moving-coil speakers introduced by B.T.H. Engineers some years ago.

Ideal for use as extension speakers, each model can be adjusted to suit the output of any receiver. The speakers are just out of the factory and are now available.



THE SENIOR D.C. MODEL
Dimensions:—
Height 13 1/4"; Width 12 1/4";
Depth 8 1/2".
Price (Cat. No. 70774)
£5. 5. 0



THE SENIOR PERMANENT MAGNET MODEL
Dimensions:—
Height 12 3/4"; Width 12 1/4";
Depth 6 3/4".
Price (Cat. No. 70771)
£5. 17. 6

EDISWAN

THE EDISON SWAN ELECTRIC CO. LTD.
155 Charing Cross Road, London, W.C.2
Distributors for the British Thomson-Houston Co. Ltd., Rugby RA 310.



THE SENIOR A.C. MODEL
Dimensions:—
Height 13 1/4"; Width 12 1/4";
Depth 8 1/2".
Price (Cat. No. 70773)
£6. 17. 6

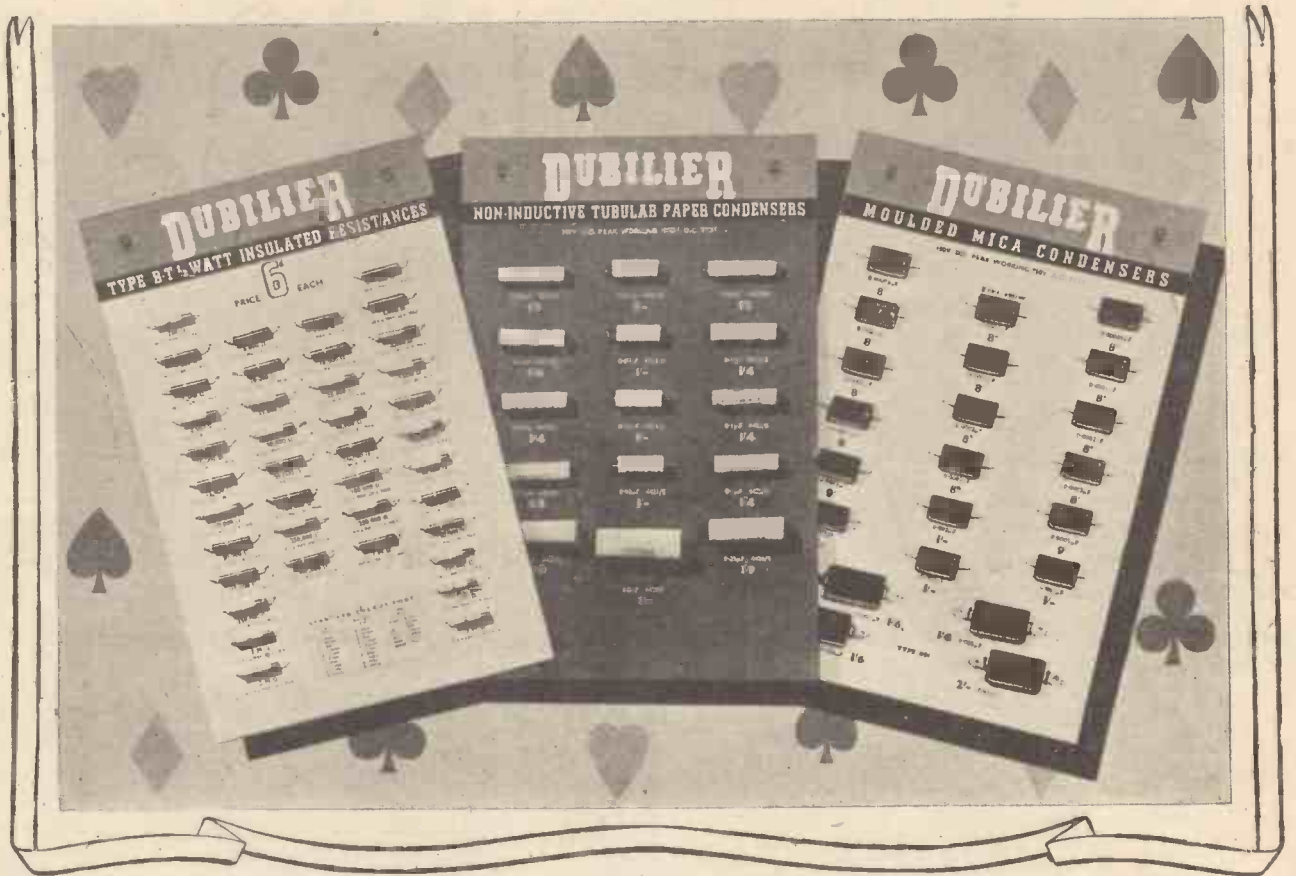

We put our cards on the market

We are now marketing a number of our components on cards. And in doing so we really have "put our cards on the table." Every possible detail you or your customers could wish for is clearly given—and given most attractively too, in three colours. You'll like these cards if only for the shelf space they'll save you. About the resistances we tell you—price, value in ohms, colour code, maximum current they should carry and maximum voltage that should be applied. About the condensers we tell you—price, value in microfarads, maximum

peak working voltage and test voltage. That should cover most of your requirements.

We have separate cards for our B.T. 1/4 Watt Insulated Resistances, B.T. 1 Watt Insulated Resistances, Moulded Mica Condensers, Type 442I/E Non-Inductive Tubular Paper Condensers, and a further card for varied types of Tubular Papers. Each card has a retail price of £1. We are, of course, also continuing to supply these products in individual cartons.

DUBILIER CONDENSERS

DUBILIER CONDENSER CO. (1925) LTD., DUCON WORKS, VICTORIA ROAD, NORTH ACTON, LONDON, W.3



C. R. Casson 122

Mention of "The Wireless World." when writing to advertisers, will ensure prompt attention.

The Wireless World

THE
PRACTICAL RADIO
JOURNAL
27th Year of Publication

No. 919

FRIDAY, APRIL 9TH, 1937.

VOL. XL. No. 15.

Proprietors: ILIFFE & SONS LTD.

Editor:
HUGH S. POCOCK.

Editorial,
Advertising and Publishing Offices:
DORSET HOUSE, STAMFORD STREET,
LONDON, S.E.1.

Telephone: Waterloo 3333 (50 lines).
Telegrams: "Ethaworld, Sedist, London."

COVENTRY: Hertford Street.
Telegrams: "Autocar, Coventry." Telephone: 5210 Coventry.

BIRMINGHAM:
Guildhall Buildings, Navigation Street, 2.
Telegrams: "Autopress, Birmingham." Telephone: 2971 Midland (4 lines).

MANCHESTER: 260, Deansgate, 3.
Telegrams: "Iliffe, Manchester." Telephone: Blackfriars 4412 (4 lines).

GLASGOW: 26B, Renfield Street, C.2.
Telegrams: "Iliffe, Glasgow." Telephone: Central 4857.

PUBLISHED WEEKLY. ENTERED AS SECOND
CLASS MATTER AT NEW YORK, N.Y.

Subscription Rates:
Home, £1 1s. 8d.; Canada, £1 1s. 8d.; other
countries, £1 3s. 10d. per annum.

*As many of the circuits and apparatus described in these
pages are covered by patents, readers are advised, before
making use of them, to satisfy themselves that they would
not be infringing patents.*

CONTENTS

	Page
Editorial Comment	341
AC Short-Wave Converter ..	342
Unconsidered Trifles	346
Television Reception	348
Letters to the Editor	350
Broadcast Brevities	351
Marconiphone All-Wave AC/DC Radiogram	352
Random Radiations	354
Unbiased	355
Listeners' Guide for the Week ..	356
About Push-Pull	358
The Television Receiver—VI ..	360
Current Topics	362
The Manufacturer's Guarantee ..	363
Recent Inventions	364

EDITORIAL COMMENT

Interference Measures

Confidence in the P.M.G.'s Attitude

AS we go to press we learn that the Postmaster-General will be asked in the House on Thursday, April 8th, what are his intentions with regard to the introduction of legislation to control electrical interference with broadcasting.

The Postmaster-General's reply will, no doubt, be generally known before this issue appears, but it is fairly safe to predict what this reply will be.

Ever since *The Wireless World* launched the campaign for legislation to control such interference, as far back as 1931, steady, though rather slow, progress has been made towards the goal we then had in view. The Institution of Electrical Engineers appointed a Committee to investigate the question following a direct incitement to do so contained in our issue of November 25th, 1932.

Legislation Recommended

The Institution Committee, after vacillating for some time on the issue whether or not legislation to control interference should be introduced or the matter left to peaceful persuasion, finally came down firmly on the right side of the fence in their report and recommendations, when they stated that "it became evident from the discussions of the Committee that the majority of members did not consider that effective interference suppression would result if the improvement of the position were to be left solely to voluntary effort."

Finally, the Committee recommended that the Electricity Commissioners should be given the necessary powers to enforce suppression.

It is known that the Postmaster-General has been prepared to support legislation, but has desired first to know that this would have the blessing of the various interests concerned. This assurance was given in the Committee's report, since the Committee was representative of all interests.

As we write, therefore, we feel confident that the Postmaster-General will express himself ready to introduce legislation and our hope is that this will be carried through with all speed in the interests of every listener.

Television

A New Era

HITHERTO the production of television programmes has been seriously hampered by reason of the fact that it has not been possible to televise subjects at distances of more than a few yards from the transmitter, except through the rather unsatisfactory medium of film.

Now comes the news that technical arrangements are expected to be completed by the date of the Coronation to enable a television transmission of the procession to be carried out.

It seems likely, too, that the B.B.C. will have a choice of either using a new coaxial cable link to the transmitter or an ultra-short wave wireless link with a transmitter operating on the spot and feeding the main transmitter at Alexandra Palace.

The Coronation has provided the impetus to get these arrangements through in a short time, and once direct television of outside subjects has been made possible, the potentialities of television as a public entertainment will have increased enormously. Provided the cost can be met, the programmes will acquire an entirely new value, and a very great step forward will have been taken.

AC Short-Wave Converter

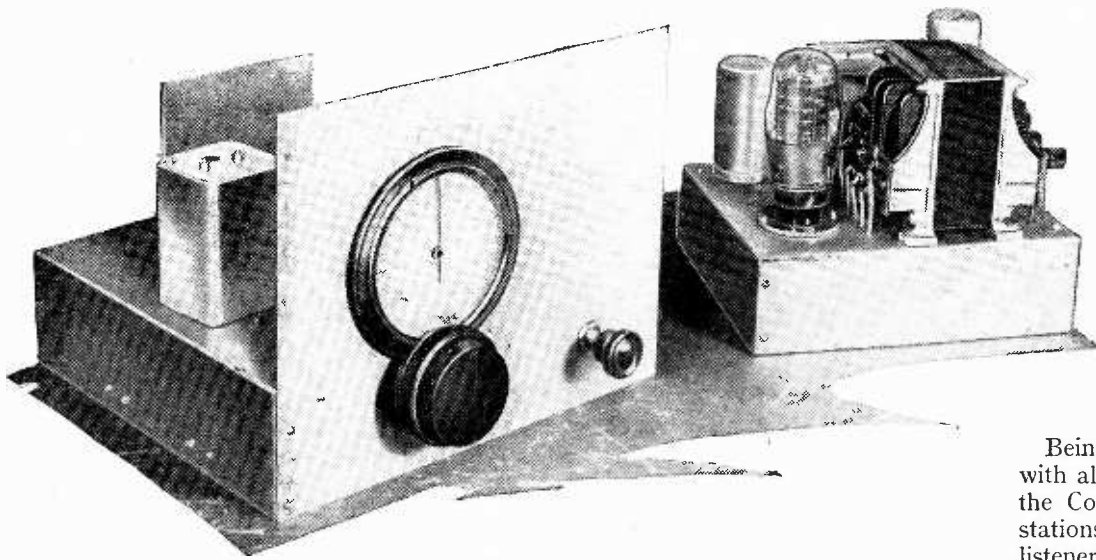

A THREE-RANGE MODEL WITH WAVEBAND SWITCHING COVERING 12.5 TO 62.5 METRE

DURING the past year or so many improvements have been effected in the technique of short-wave transmitter design, added to which there is a general tendency in all countries to increase the power of short-wave broadcast stations. Thus, it is becoming not only easier to tune in the more powerful of these stations, but the fact that they are now so well received has stimulated interest in this band where only a lukewarm curiosity existed hitherto.

The success that has attended the various rebroadcasts from the U.S. and from the British Empire in recent times provides convincing proof that distance is no obstacle to the short waves. Indeed, it is

only by the use of these very high frequencies that great distances can be covered by transmitters of reasonable size and power.

Short Waves Popular

One outcome of the interest now to be found in the short-wave region is the introduction by most radio set manufacturers of an all-wave model. The inclusion of a short-wave band in a broadcast receiver was regarded as a novelty only a few years ago, and this feature was found only in the more expensive sets, and in specialised receivers designed for overseas and colonial use.

Being so well provided in these islands with alternative programmes—for most of the Continental medium- and long-wave stations are receivable in this country—the listener has not been forced to look to distant countries for broadcast entertainment, but those living in some of the more remote parts of the Empire have no choice, and the short waves are the only medium for news and for keeping in touch with everyday affairs of the world.

As matters stand at present it seems evident that the short-wave bands are going to come very much to the fore shortly, as there appears to be keen competition among nations to make themselves heard the world over, or at least one deduces as much from the giant power stations now in course of construction or contemplated in the near future.

Thus a receiver that has facilities for short-wave reception is going to provide a lot of fun within a short time. This does

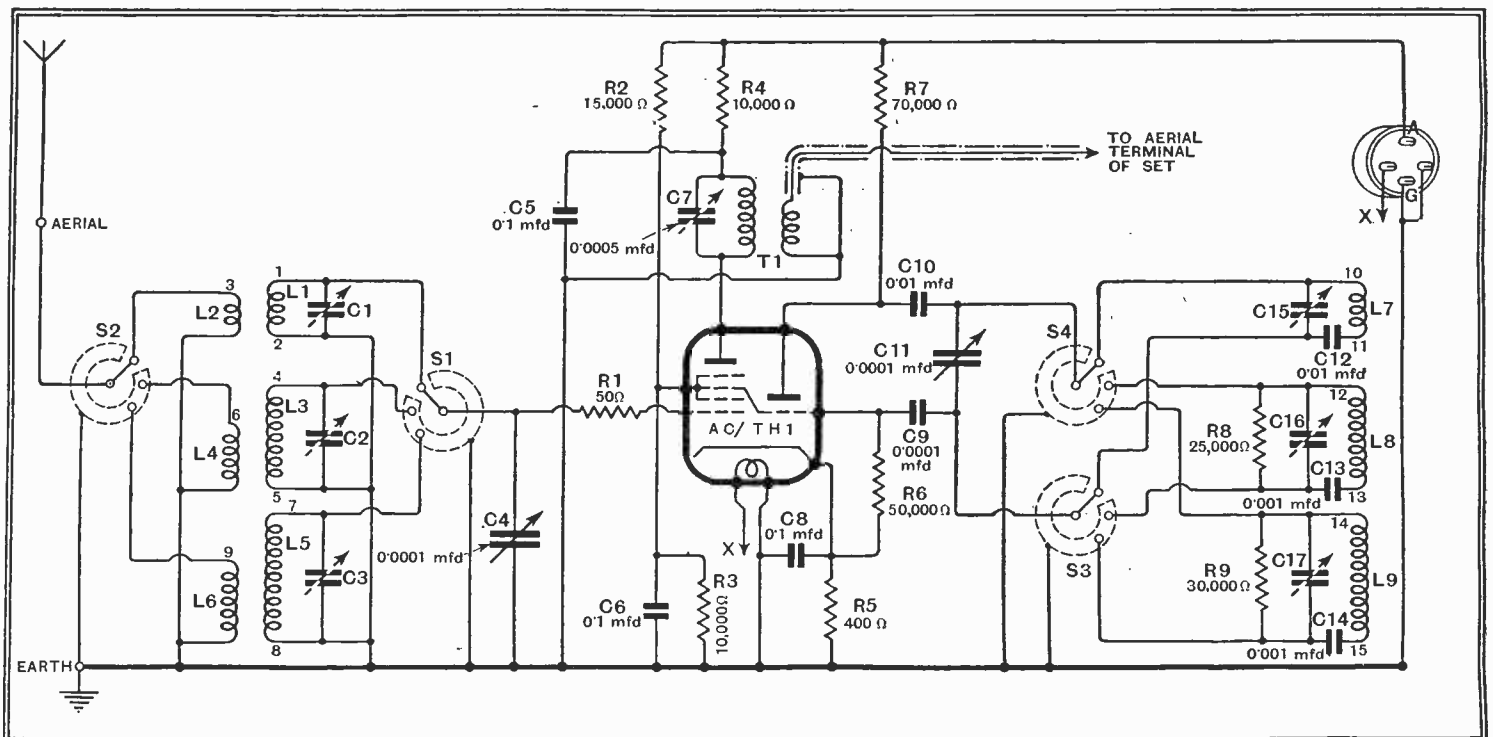

Fig. 1.—Theoretical circuit diagram of the three-range short-wave converter.

Converter

By H. B. DENT

not infer that interest is lacking on the short waves at present; on the contrary, it is the only band that enables us in this country to tune in broadcast stations outside the confines of Europe. Those who have not yet explored this region will find plenty of interest there.

Some may regard broadcast matter as the principal fare to be derived from the short waves, but it is not by any means the only interest, for this depends on the individual's outlook. If he be of the experimenter class, for want of a better expression for those who take a keen interest in short-wave working, broadcast will not be the main interest, though its reception will find a place in the scheme of things as a guide to the conditions obtaining in various parts of the band. On the other hand, amateur signals may provide the main interest.

Having decided to explore the short waves, the next point to consider is the receiver. If a good broadcast set is available, then the addition of a converter unit will offer a ready and quite satisfactory solution. The one described here is fundamentally the simplest that can be expected to give satisfaction with conditions as they are at present on the short waves, and, as will be seen from Fig. 1, it consists of a triode-hexode frequency-changer with a tuned signal circuit.

It provides three wave ranges and covers a band of 12.5 to 62.5 metres. This does not seem very wide at first sight, but actually it is fourteen times wider in kc/s than both the medium and the long broadcast bands put together, despite the fact that tuning condensers of 100 mmfds only are used. Oscillator and signal circuit condensers are ganged. A wider coverage even in three ranges would render tuning too critical for comfortable handling even with a good slow-motion drive.

The precaution is taken to short-circuit all the coils not actually in use so as to prevent the idle coils resonating with the stray capacities and forming absorption circuits and thus reducing the efficiency. This is effected by employing a switch fitted with a centre metal plate that short-circuits the idle coils and having three "live" contacts and an additional one that is always in contact with the metal plate. This contact is joined to the earth line.

Colpitts Oscillator

Risk of shorting the HT in the oscillator section (for it will be seen that a modified Colpitts circuit is used) is avoided by shunt-feeding the oscillator anode through a 70,000-ohm resistance R7 and using a blocking condenser C10. Each of the six coils has a parallel padding condenser, and these are in banks of three, one bank

being contained in each compartment of the coil box.

Attention is drawn to the 50-ohm resistance R1 close to the signal circuit grid of the frequency-changer. It is included as an anti-parasitic resistance, as a tendency was noticed for parasitic oscillations to appear at the lower part of range 1.

The anode or output circuit of the frequency-changer is tuned to the intermediate frequency, which in this case is 550 kc/s, approximately 550 metres. A special transformer is used with a step-down ratio of about 1 to 3, and its secondary is joined by a screened lead to the aerial terminal of the broadcast set.

The set to use with this converter can be either a superheterodyne or a straight set, but in the case of the last mentioned it is necessary that it include at least one RF stage. This proviso does not apply to superheterodyne receivers.

In order to render the converter independent so that it does not rely on the broadcast set for its operating voltages a separate power pack is provided. Taking HT and LT from the main receiver gives no control over the operation conditions of the short-wave frequency-changer, since the available voltage is rarely the same in any two sets, whereas with its own power unit the correct voltages can be used.

It would be advisable to draw attention to the two resistances, R8

Only the tuning condensers and the output transformer are mounted on the top of the chassis.

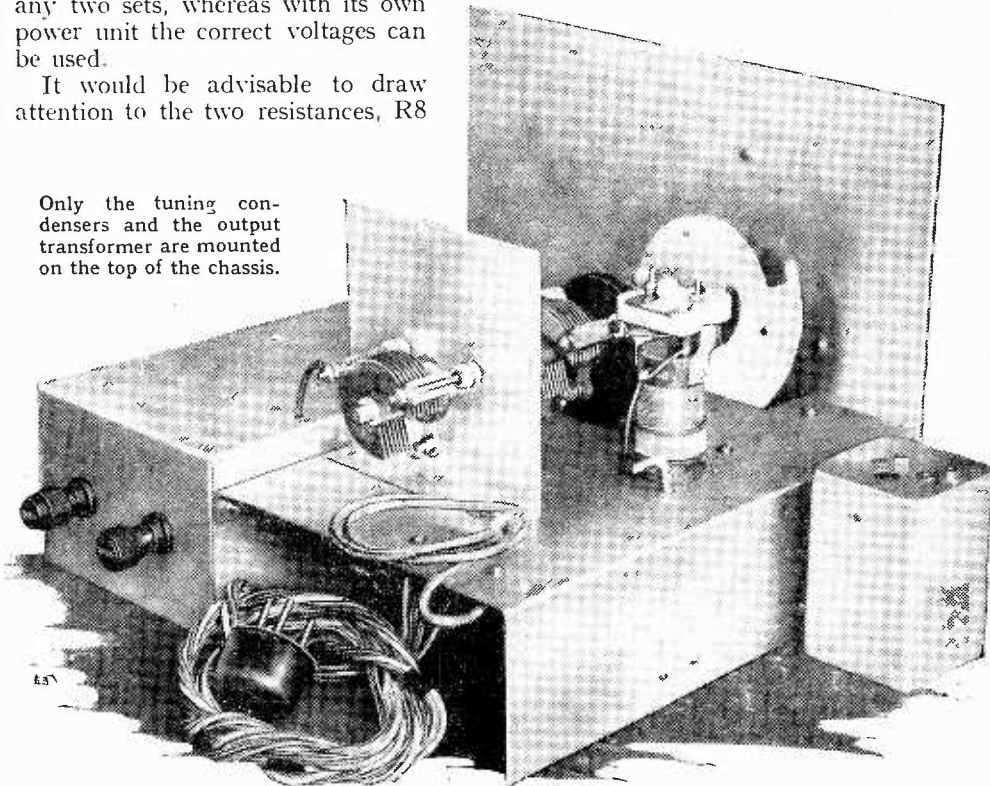

and R9, shunted across the oscillator coils L8 and L9 respectively. These are the coils for ranges two and three respectively, and their purpose is to equalize the oscillator output on all three ranges.

A feature of interest in regard to the converter is that the coils and switching are contained in a separate screening box, but the coil units form an integral part of the chassis, though it can be removed by disconnecting the external wires without disturbing any other part of the converter.

The reason for adopting this form of construction is that it enables the complete coil unit to be constructed apart from the

set, and if desired it could be purchased as a complete unit, wired and tested and ready for assembling in the converter. The British Television Supplies, Ltd., have intimated that they are prepared to supply the coil unit as designed, though full constructional details are given for the benefit of those readers who would prefer to make it.

Simplifying Adjustment

It has been found possible to reduce the number of adjustments needed in the initial test stage by dispensing with variable series tracking condensers in the oscillator circuits and fitting fixed condensers. C12 of 0.01 mfd. for range 1 can be a standard type with a tolerance of ± 15 per cent., but for C13 and C14, each of 0.001 mfd., condensers with tolerances not exceeding ± 5 per cent. must be used. Only the parallel padders in the oscillator and signal circuits, and there is one for each coil, will require adjusting, but this will not be found at all difficult, since the values chosen are such that if the layout and coil construction are strictly followed no diffi-

culty will be encountered in the initial adjusting of the circuits. However, this matter will be discussed in detail later in the operating notes.

The drawing of the coil unit, together with the winding data contained in the table, provide all the essentials details for building this part of the converter, and as they are self-explanatory a written description seems hardly necessary.

There is, however, one useful piece of advice that can be passed on, and this relates to the construction of the coil box. Originally this was cut from one piece of aluminium, with the sides and ends bent

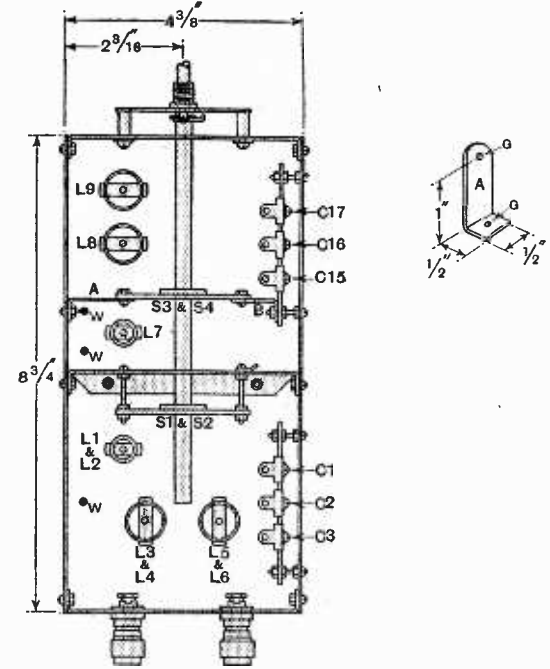
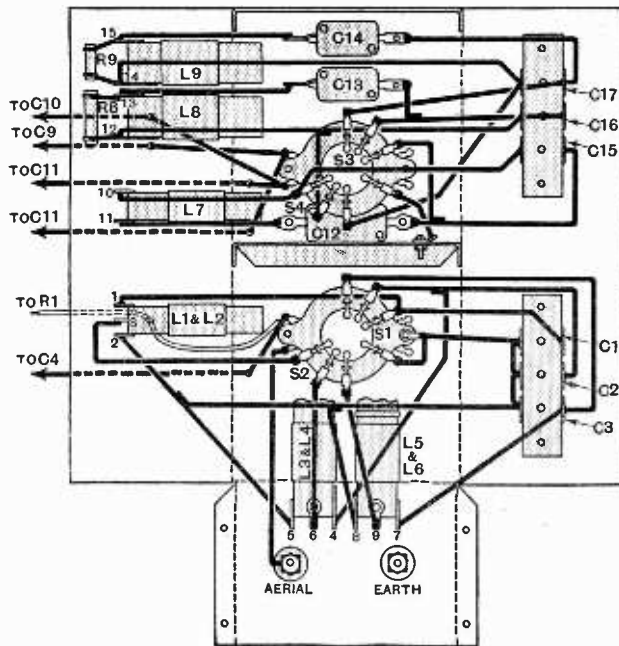
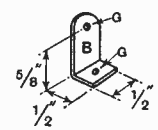
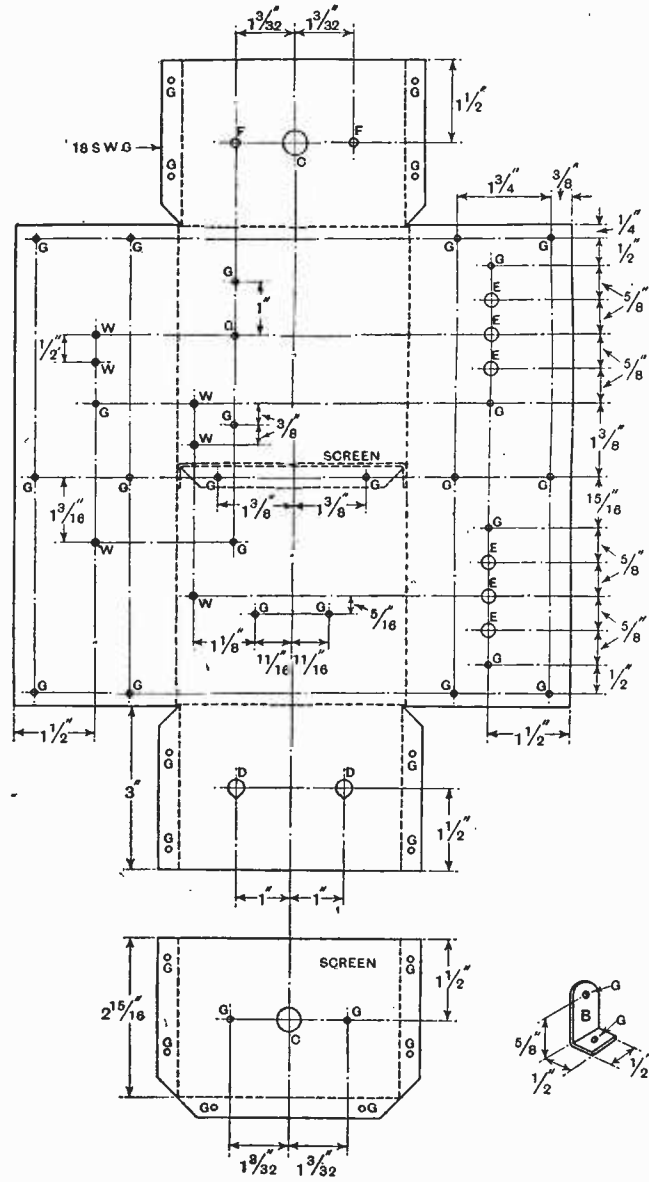
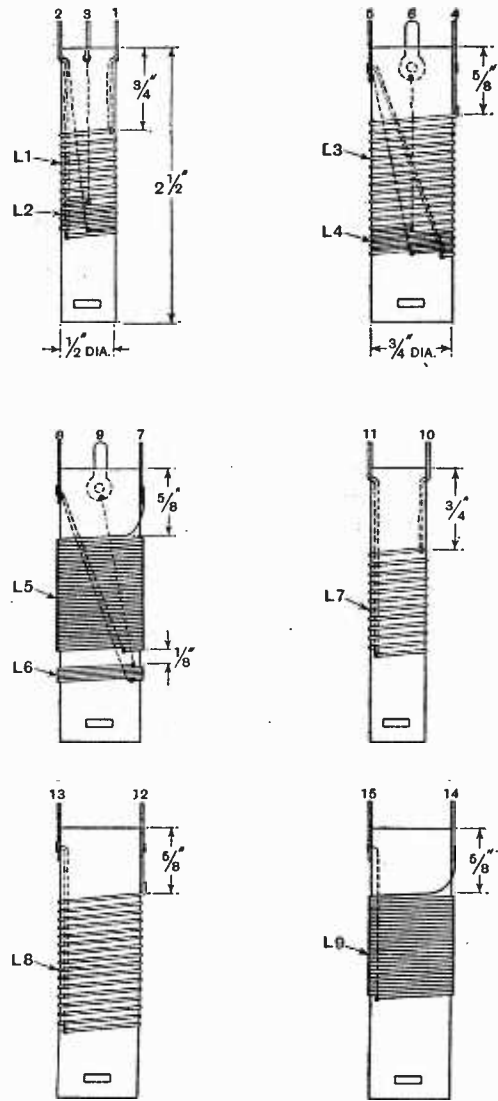

Dimensional drawing of the coil box, with the layout of the components and the wiring details. Sizes of the holes are as follows:—C=7/16 in. dia.; D=5/16 in. dia.; E=1/4 in. dia.; F=5/32 in. dia.; G=1/8 in. dia., and W are the holes to pass connecting wires. Constructional details of the coils are also included.

AC Short-Wave Converter—

up and the edges turned over for bolting together.

Though ample space was provided in each compartment it subsequently transpired that some of the connections, especially those at the bottom of the switches, were a little awkward to reach unless one had a soldering iron with a long thin bit.

In order to render them more accessible it is suggested that the coil box be made with separate end pieces and only the bottom and the sides be made in one piece.

The switches can then be assembled and lined up with the end-pieces in place, after which the latter can be removed, together with the switch rod and the locator plate.

By adopting this suggestion the interior wiring of the coil box will be much simplified, as the lower contacts of the switches become accessible from each end even though a soldering iron with a large and broad bit be used.

In the concluding part of the article the assembly of the converter and power pack will be described.

LIST OF PARTS.

Certain components of other makes but of similar characteristics may be used as alternatives to those given in the following list.

- 2 Variable condensers, 100 mmfds. Eddystone 900 C4, C11
- 2 Flexible couplers Eddystone 1009
- 1 Condenser drive, two-ratio Eddystone 1070
- 2 Stand-off insulators Eddystone 1019
- 1 Valve holder, 7-pin, without terminals Clix Chassis Mounting S.W. Type V5
- 1 Group board, 5-way Bulgin C31
- Condensers:**
 - 3 0.1 mfd., tubular T.C.C. 250 C5, C6, C8
 - 2 0.01 mfd., mica T.C.C. "M" C10, C12
 - 1 0.0001 mfd. mica T.C.C. "M" C9
 - 2 0.001 mfd., mica, tolerance ± 5 per cent. T.C.C. "M" C13, C14
- Resistances:**
 - 1 50 ohms, $\frac{1}{2}$ watt Erie R1
 - 1 25,000 ohms, $\frac{1}{2}$ watt Claude Lyons R8
 - 1 30,000 ohms, $\frac{1}{2}$ watt Claude Lyons R9
 - 1 50,000 ohms, $\frac{1}{2}$ watt Claude Lyons R6
 - 1 400 ohms, 1 watt Claude Lyons R5
 - 1 10,000 ohms, 1 watt Claude Lyons R4
 - 1 70,000 ohms, 1 watt Claude Lyons R7
 - 1 10,000 ohms, 2 watts Claude Lyons R3
 - 1 15,000 ohms, 3 watts Claude Lyons R2
- 1 Trimming condenser, single type, 500 mmfds. max. Hunts 3276TD C7
- 1 Connector, four-way Bryce Light Pattern
- 1 Plug-top valve connector Belling-Lee 1175
- 2 Switches, 2-pole 3-way with earthing plate and tag B.T.S.-B123FET S1/S2, S3/S4
- 1 Switch rod and locator, 7in. long B.T.S.
- 2 Multiple strip condensers, 3-way, 30 mmfds. Bulgin SW101 C1, C2, C3, C15, C16, C17
- 2 Coil formers, $\frac{3}{4}$ in. dia. \times $2\frac{1}{2}$ in. long, threaded 12 tpi. B.T.S.

- 2 Coil formers, $\frac{3}{4}$ in. dia. \times $2\frac{1}{2}$ in. long, threaded 14 tpi B.T.S.
- 2 Coil formers, $\frac{3}{4}$ in. dia. \times $2\frac{1}{2}$ in. long, plain B.T.S.
- 1 Coil former, 1in. dia. \times 2in. long, plain B.T.S.
- 2 Terminals, ebonite shrouded Belling-Lee "B"
- 1 Aluminium coil screen, $2 \times 2 \times 3$ in. Goltone R9/328

Valve: 1 AC/TH.1

Mazda

POWER PACK.

- 1 Mains transformer: 250-0-250 volts, 60 mA., 4 volts, 2.5 amps., centre tapped, 4 volts, 2/3 amps. All Power PT/AP
- 1 Smoothing Choke, 50 henries, 25 mA Bulgin LF17S

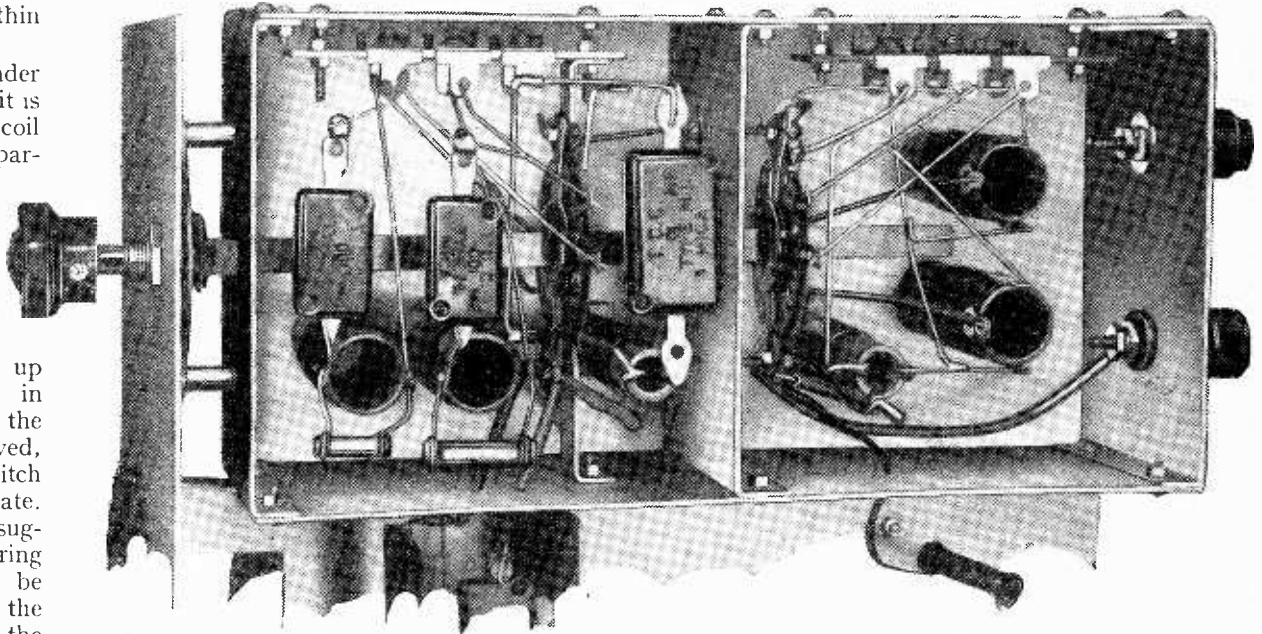

The coils and switching are contained in a separate unit which is bolted to, but actually forms part of, the chassis.

- 1 Battery cable, 4-way Bulgin BC2
- 1 Plug, 4-pin Bulgin P9
- 1 Length screened sleeving, 2 mm. Goltone R39/281
- Miscellaneous:** Peto-Scott
 - 3 lengths systoflex; small quantity Nos. 18 and 20 enamel wire, Nos. 20 and 34 D.S.C. wire, Nos. 16 and 18 tinned copper wire, Aluminium for coil unit, chassis, partitions, valve bracket, condenser support and panel. Small ebonite bracket for condenser, 6BA studding, etc. Screws: 24 $\frac{3}{4}$ in. No. 6 R/hd., 12 $\frac{1}{2}$ in. No. 6 R/hd., 8 1in. No. 6 R/hd., all with nuts and washers; 2 6BA with 8 nuts and washers.
- 1 Condenser, dry electrolytic, 8 mfd., 500 volts peak Polar-N.S.F. C18
- 1 Condenser, dry electrolytic, 4 mfd., 500 volts peak Polar-N.S.F. C19
- 2 Valve holders, 5-pin, chassis type Bulgin VH13
- Miscellaneous:** Peto-Scott
 - 3 lengths systoflex; small quantity Nos. 16 and 20 tinned copper wire, aluminium for chassis, etc. Screws: 22 $\frac{3}{4}$ in. No. 6 R/hd., 6 $\frac{1}{2}$ in. No. 4 R/hd., all with nuts and washers.
- Valve: 1 UU4 Mazda

COIL WINDING DATA.

Coil No.	Description.	Former dia.	Turns.	Wire.	Winding.
L1	Range 1 signal circuit ...	$\frac{1}{2}$ in.	11 $\frac{1}{2}$	No. 18 SWG EN	Turns spaced 12 tpi.
L2	Aerial coil ...	—	3	No. 34 SWG DSC	Interwound with L1 on earth end of former.
L3	Range 2 signal circuit ...	$\frac{3}{4}$ in.	16	No. 20 SWG EN	Turns spaced 14 tpi.
L4	Aerial coil ...	—	3	No. 34 SWG DSC	Interwound with L3 on earth end of former.
L5	Range 3 signal circuit ...	$\frac{3}{4}$ in.	28	No. 20 SWG DSC	Turns close wound.
L6	Aerial coil ...	—	6	No. 34 SWG DSC	Turns close wound on earth end of former; spaced $\frac{1}{8}$ in. from L5.
L7	Range 1 oscillator circuit...	$\frac{1}{2}$ in.	11 $\frac{1}{2}$	No. 18 SWG EN	Turns spaced 12 tpi.
L8	Range 2 oscillator circuit...	$\frac{3}{4}$ in.	15 $\frac{1}{2}$	No. 20 SWG EN	Turns spaced 14 tpi.
L9	Range 3 oscillator circuit...	$\frac{3}{4}$ in.	25 $\frac{1}{2}$	No. 20 SWG DSC	Turns close wound.

The coil formers can be Paxolin or bakelised tubes of diameters stated with walls $\frac{1}{16}$ in. thick, and each is 2 $\frac{1}{2}$ ins. long. Slots are cut in the sides at the earth end of each coil as shown in the drawings and small pieces of $\frac{1}{4}$ in. wide strip brass $\frac{1}{16}$ in. thick are inserted. These are drilled and tapped 6 BA to take the fixing screws.



Unconsidered Trifles

UNEXPLORED
BY-WAYS
ON THE SHORT
WAVEBANDS

By

J. GODCHAUX ABRAHAMS

IN view of the daily increasing number of short-wave broadcasts which the listener may now pick up from distant stations overseas, I am of opinion that we are rather too prone to neglect the transmissions which can be more easily received daily from points nearer home, namely, the European continent. Much less frequent mention is made of these signals, yet they are those which the purchaser of a so-called "all-wave" or three- or four-band receiver is more likely to tune in at the outset. By all means let him try for the more distant stations, but if he desires certainties during his apprenticeship he will do well to go all-out for the more powerful broadcasts at his disposal—e.g., those emanating from the nearer European centres.

It is the logging of these Continentals—a comparatively easy task—which will facilitate a search for more distant, and in most instances weaker, signals. Whether a condenser dial is marked in degrees, wavelengths, kilocycles, or stations, or combines two or more of these features matters little providing an accurate reading of the pointer can be obtained for the purpose of recording channels. It is essential that the exact point on the scale should be carefully noted if the same station is to be found again at a later date. Personally, for exact logging, I prefer a scale minutely divided into degrees, as where stations are marked, however small the type may be compatible with legibility, the separation of channels is so slight that one may well find two or three programmes within the space occupied by one station name alone.

Overlapping Wavebands

Another point of importance, and one less understood by the beginner, is that of the overlap existing in the individual bands. The total range covered by receivers of different makes varies slightly, but where two short wavebands are in-

corporated the ranges are roughly from 13-33 metres (23-9 Mc/s) and from 30-82 metres (10-3.7 Mc/s). This overlap will be found very useful, as experience will show that in some instances it will be possible to secure better reception of transmissions made on wavelengths between, say, 30-33 m. at the bottom of the 30-82 m. range than at the top of the 13-33 m. section. As it happens, this is a bracket which comprises a very large number of broadcasts and one over which specially slow and careful tuning is likely

THE author gives many useful hints for newcomers to short-wave listening, and also describes a number of lesser-known but, nevertheless, interesting transmissions, giving lists of wavelengths on which they are conducted.

to provide very pleasant results. You will come across many carrier waves, and every one of these is worth a short examination, especially in the later hours of the evening when many of the European medium-wave stations close down and there is less likelihood of a signal proving to be a mere harmonic of a more or less near-by transmission.

It must be borne in mind that searching for stations on the short wavebands differs from the practice commonly adopted by users of receivers solely capable of tuning in broadcasts on the medium and long wavebands. In the latter case almost every portion of the dial reveals broadcasts in view of the fact that the bands selected are those which contain the frequencies allotted to radiotelephony transmitters. On the other hand, the range covering, say, 13-82 metres includes a large number of channels almost exclusively occupied by morse (telegraphy) or commercial telephony transmitters whose frequencies, for obvious reasons, may not be used by stations devoting themselves to wireless entertainment. On this account, if the beginner is ignorant

of the channels allotted to broadcast telephony, he may waste considerable time in endeavouring to find that class of programme. With but few exceptions broadcasting stations will be found on channels comprised within the following limits:—

11.28-11.72 m.	(26,600-25,600 kc/s).
13.92-13.99 m.	(21,550-21,450 kc/s).
16.85-16.90 m.	(17,800-17,750 kc/s).
19.54-19.87 m.	(15,350-15,100 kc/s).
25.21-25.64 m.	(11,900-11,700 kc/s).
31.25-31.58 m.	(9,600-9,500 kc/s).
48.78-50. m.	(6,150-6,000 kc/s).

Unfortunately, however, there exists a certain number of transmitters which must be classed as exceptions; incidentally, many of the new South American and West Indian short-wave transmitters are working on channels falling in the 44.93-48.78 m. (6,675-6,150 kc/s) band.

The time question is an important factor; by time is implied the hour of the day or night at which to listen to signals on different sections of the waveband. Many transmitters utilise a number of channels which are best suited for transmissions destined to countries overseas at the hour most convenient to listeners. Taking it broadly, during April and May, from about 11.0 a.m. to 6 or 7 p.m., searches should be made for broadcasts on the 16- and 19-metre bands. Transmissions on the 25- and 31-metre bands may be picked up at good strength from 1 p.m., and often held until the early morning hours. From 6 p.m. or 8 p.m. the 49-metre band comes into its own and may be successfully scoured until 7 a.m. the next morning or even later.

Relayed Transmissions

The identification of a transmitter is not always an easy matter. Note that I mention *transmitter*, and not *transmission*, as, in most instances, in view of the frequent interval signals and announcements, it is not difficult to trace the origin of a broadcast. But the transmission may be on a channel which does not tally with any usually associated with the city from which the programme emanates. The explanation is, generally, that the entertainment is being relayed by a commercial telephony station for re-broadcast in a foreign country. This may present some trouble in identifying the actual transmitter, although there may arise no doubt whatsoever as to the nationality of the actual broadcast. A short list of the prin-

Unconsidered Trifles

cial stations which carry out this work will prove useful.

PRINCIPAL RE-BROADCAST STATIONS

GERMANY.—ZEESEN, DZG, 19.53 m. (13,360 kc/s); **DZH,** 20.75 m. (14,460 kc/s); **DZE,** 21.73 m. (12,130 kc/s); **DJP,** 25.31 m. (11,855 kc/s); **DJO,** 25.43 m. (11,795 kc/s); **DZB,** 29.87 m. (10,042 kc/s); **DZA,** 31.01 m. (9,675 kc/s); and **DZM,** 49.35 m. (6,079 kc/s).

SWITZERLAND.—PRANGINS, HBF, 15.83 m. (18,950 kc/s); **HBJ,** 20.64 m. (14,535 kc/s); **HBL,** 31.27 m. (9,595 kc/s); and **HBO,** 24.94 m. (12,030 kc/s).

UNITED STATES.—ROCKY POINT (N.Y.), WQE, 15.86 m. (18,920 kc/s); **WQB,** 16.72 m. (17,940 kc/s); **WLL,** 16.74 m. (17,900 kc/s); **WQV,** 20.27 m. (14,800 kc/s); **WEB,** 20.31 m. (14,770 kc/s); **WQP,** 21.58 m. (13,900 kc/s); **WEA,** 28.28 m. (10,610 kc/s); **WQW,** 28.30 m. (10,600 kc/s); **WCG,** 28.9 m. (10,380 kc/s); **WEL,** 33.52 m. (8,590 kc/s); and **WEZ,** 37.15 m. (8,075 kc/s). **LAWRENCEVILLE (N.J.), WKF,** 15.61 m. (10,220 kc/s); **WLA,** 16.36 m. (18,340 kc/s); **WMN,** 20.56 m. (14,590 kc/s); **WMF,** 20.73 m. (14,470 kc/s); **WMA,** 22.4 m. (13,390 kc/s); **WON,** 30.4 m. (9,870 kc/s); and **WOF,** 30.77 m. (9,750 kc/s).

Few commercial broadcast receivers are built to receive the transmissions on the 5 m. (60 Mc/s), 10 m. (30 Mc/s), and 160 m. (1.8 Mc/s) bands used by amateur experimental transmitters, but in the course of an evening's condenser twiddling the listener is bound to pick up calls and hear exchanges of conversation on channels used by them in the 20 m. (14 Mc/s), 40 m. (7 Mc/s), and 80 m. (3.5 Mc/s) amateur bands.

Wavelengths and frequencies allowed to these experimenters are given hereunder, and in order to facilitate searching a few details are added in respect to the channels granted or prohibited by a few of the more active European countries to their national "fans." A special article would have to be devoted to the translation of the radio jargon which is heard when these signals are tuned in, as many of the terms, although perfectly clear to those in the know, must undoubtedly puzzle the casual listener.

AMATEUR TRANSMITTING BANDS (approximately):—

5-5.357 m. (60,000-56,000 kc/s).
10-10.71 m. (30,000-28,000 kc/s).
20.83-21.43 m. (14,400-14,000 kc/s).
41.10-42.86 m. (7,300-7,000 kc/s).
75-85.71 m. (4,000-3,500 kc/s).

In Germany the 5 m. and 160 m. bands may not be used, and the 80 m. section is limited to 83.28 m.-85.66 m. (3,600-3,500 kc/s). British amateurs will be found using channels comprised in the following bands: 5.0-5.34 m. (59,995-56,005 kc/s); 10.02-10.72 m. (29,995-28,050 kc/s); 20.84-21.4 m. (14,395-14,005 kc/s); 41.10-42.8 m. (7,295-7,005 kc/s); 80.38-85.5 m. (3,730-3,505 kc/s); 150.30-174.30 m. (1,995-1,720 kc/s). In Switzerland the 160-metre band is prohibited, and the 80 m. band extends from 81.03-85.66 m. (3,700-3,500 kc/s). In Austria licences are granted for channels between 83.28 m.-85.66 m. (3,600-3,500 kc/s), but not for 160 m. In Denmark the channels most used are 152.2 m. (1,970 kc/s),

163.8 m. (1,830 kc/s) and 173.3 m. (1,730 kc/s), 80 m. (as in Germany); also from 41.13-42.77 m. (7,290-7,010 kc/s); 20.85-21.40 m. (14,380-14,020 kc/s); 10.01-10.7 m. (29,970-28,030 kc/s); 5.05-5.34 m. (59,900-56,100 kc/s). Finnish amateurs do not work on the 160 m., but on all other bands, and, finally, in the U.S.A. the 10 m., 20 m., 80 m., and 160 m. bands are allowed for telephony but not the 40-metre band.

Ship to Shore Traffic

In the same way, radio-telephony from ships at sea—in most instances from the more important liners—will crop up occasionally. Transmissions of this description are usually carried out on channels comprised between 16.85-18.27 m. (17,800-16,420 kc/s); 22.50-24.30 m. (13,335-12,345 kc/s); 33.93-36.59 m. (8,842-8,200 kc/s); 67.87-73.17 m. (4,420-4,100 kc/s). The different frequencies, as in the case of land or fixed transmitters, are used according to the time of day and, in addition, the choice of the channel is influenced by the ship's position at the time communication with either her home or a foreign port is to be established. If, on the journey outwards, the French transatlantic liner *Normandie* (FNSK), as an example, tries to get into touch with New York in the morning hours either 13.6 m. (22,060 kc/s) or 17 m. (17,650 kc/s) would be the wavelength selected for the purpose. Later, in the afternoon, 22.71 m. (13,210 kc/s) would be used, and after dusk, 33.98 m. (8,830 kc/s). When relatively near her destination messages would be sent out on 68.03 m. (4,410 kc/s). On the other hand, when desiring to communicate with a French station slightly different channels would be adopted, namely, 13.61 m. (22,040 kc/s); 17.02 m. (17,630 kc/s) during early daylight hours; 22.74 m. (13,190 kc/s) if afternoon; 34.05 m. (8,810 kc/s) after sunset and 68.34 m. (4,390 kc/s) when at no great distance from the coasts of Europe.

There is no secret in the channels used by liners or land stations for the public telephony services, but it should be remembered that these, as all transmissions which are not of the broadcasting type, must be deemed of a private nature and, in consequence, according to the terms of the Post Office listening licence, may not be revealed to a third party or, in any other way, communicated. Whilst on the subject of shipping it may be of interest to note that DOAI, *Europa*, DOAH, *Bremen*, DHJZ, *Hamburg*, and DHEY, *Deutschland*, as representatives of the German transatlantic ferries, can frequently be heard operating on 18 m. (16,665 kc/s); 23.81 m. (12,600 kc/s); 24.34 m. (12,325 kc/s); 26.93 m. (11,140 kc/s); 35.42 m. (8,470 kc/s); and 74.07 m. (4,050 kc/s). ICEJ, *Rex*, IBLI, *Conte de Savoia*, IBGI, *Conte Verde*, and IBEJ, *Conte Rosso* of the Italian mercantile fleet work with IAC, *Coltano* (near Pisa, Italy) on such channels as 17.01 m. (17,640 kc/s); 17.31 m. (17,333 kc/s);

22.99 m. (13,050 kc/s); 33.98 m. (8,830 kc/s); 34.61 m. (8,667 kc/s); 35.14 m. (8,538 kc/s); 68.97 m. (4,350 kc/s) and 71.82 m. (4,177 kc/s). From *Coltano* (Italy) clear speech will often be tuned in on one of the following frequencies: 16.95 m. (17,699 kc/s); 23.45 m. (12,795 kc/s); 35.80 m. (8,380 kc/s); 45.11 m. (6,65 kc/s) and 68.88 m. (4,355 kc/s). Germany, on the other hand, keeps in touch with her vessels through DAF, *Norddeich*, of which the busiest channels are: 17.38 m. (17,265 kc/s); 22.90 m. (13,100 kc/s); 34.23 m. (8,765 kc/s) and 68.18 m. (4,440 kc/s). France, on the other hand, works radio-telephony through Paris TSF and St. Nazaire. Transmissions should be sought on 17.78 m. (16,870 kc/s); 23.22 m. (12,920 kc/s); 23.61 m. (12,705 kc/s); 23.87 m. (12,570 kc/s) 35.46 m. (8,460 kc/s) and others.

The field of exploration for the short-wave listener is a vast one, and gives him a radius of action far surpassing that vouchsafed to the man who searches for distant stations merely on the medium and long wavebands.

Club News**Leeds Radio Society**

Headquarters: Y.C.C.A., Cookridge Street, Leeds, 2.
Hon. Sec.: Mr. J. Kavanagh, 63, Dawlish Avenue, Leeds, 9.

The most popular of the Society's recent activities proved to be the visits to the North Regional transmitter, the Leeds studios and the Kirkstall Power Station. Mr. Gauthy, A.M.I.R.E. (G6GA), has been giving a very interesting series of lectures.

Exeter and District Wireless Society

Headquarters: Y.W.C.A., 3, Dix's Field, Southernhay, Exeter.
Hon. Sec.: Mr. W. J. Cling, 9, Sivell Place, Heavitree, Exeter.

Dr. C. Wroth aroused considerable interest by his lantern lecture on the high frequencies used by the medical profession. Dr. Wroth was assisted by Mr. Pemberton of the Royal Devon and Exeter Hospital in demonstrating how radium is detected and recovered when lost in hospital dressings.

There was a very good attendance of members at the lecture on "Electricity as applied to Agriculture," given by Mr. L. W. Cornish, of the Exeter City Electricity Undertaking. On April 12th, Mr. R. C. Lawes will give a talk on short and ultra-short waves.

Croydon Radio Society

Headquarters: St. Peter's Hall, Ledbury Road, 8, Croydon.
Meetings: Tuesdays at 8 p.m.
Hon. Pub. Sec.: Mr. E. L. Cumbers, 14, Campden Road, South Croydon.

At the annual general meeting a discussion took place on future programmes and it was decided to include a proportion of musical talks. Members asked for more short-wave lectures and demonstrations. The final meeting of the session will be held on April 13, when Mr. H. G. Salter will give a gramophone recital.

Cardiff and District Short-wave Club

Hon. Sec.: Mr. H. H. Phillips, 132, Clare Road, Cardiff.

At the last meeting of the club, Mr. R. T. Matthews, G8AM, gave a talk on CO/PA transmitters, followed by a demonstration. This talk was one of a series for the amateur transmitter. At the next meeting on April 15th, Mr. H. H. Phillips, 2BQB, will give a talk and demonstration of interest to the receiving members of the society. Subsequent meetings have been arranged for April 29th, and May 13th and 27th.

Television Reception

NOTES ON THE DESIGN OF MODERN RECEIVING EQUIPMENT

IN considering television equipment it is not sufficient merely to discuss the receiver proper, for the associated apparatus is just as important. Every part, from the aerial to the cathode-ray tube, must be correctly designed if the complete apparatus is to function properly.

A dipole aerial is usually adopted and connected to the receiver by a feeder, and the same aerial is employed for reception of both the sound and the vision transmissions. Since a resonant aerial of this type has selective properties its damping, either natural or artificial, must be high enough to enable the sidebands of the vision transmission to be passed. The transformation ratio between field-strength (V/m.) and input voltage is about 0.5-2.0.

According to measurements made by Scholz the field-strength decreases with distance from the transmitter approximately according to a square law, while Holmes and Turner find that at 7 metres with an aerial power of 1 kW. field-

IN this article some notes are given on the design of receiving apparatus for television, and the question of time-bases receives particular attention. The material is derived from the work of the well-known German pioneer, Manfred von Ardenne.

strengths of under 1 mV/m. are obtained at distances of 10-15 km. This is with an aerial height of 100 m. and for transmissions over a city. This order of field-strength leads to a receiver input of about 1 mV.

The total noise level is made up of the sum of the external and internal noise. The former is generally caused by electrical apparatus and car ignition systems, while the latter is made up in about equal parts by thermal agitation and shot effect. For a band-width of 4 Mc/s and an input circuit impedance of 1,000 ohms, the internal noise level is of the order of 0.03 mV. Consequently, a signal input of 1 mV. must be provided if 3 per cent. interference modulation is considered tolerable.

The vision receiver is usually a super-heterodyne, and for the avoidance of interference the intermediate frequency must not be lower than the highest modulation frequency. The frequency generally lies between 8 Mc/s and 20 Mc/s.

Since the frequency-changer introduces about three times as much noise as an amplifier, it is preceded by an RF stage. In order that the noise level shall be governed by this stage, its amplification

must be greater than 3 times. Tuning is better carried out by means of variable inductances than by the more usual variable condensers, since higher amplification can be secured with the greater L/C ratio. The circuits must be correctly damped by suitable resistances.

The IF Amplifier Couplings

In the IF amplifier it is possible to secure stage gains of 5-10 times with modern valves even when modulation frequencies as high as 2 Mc/s must be catered for. With single sideband working the stage gain can be doubled, but it has not yet been proved that such good picture definition is obtainable with this system. The following types of intervalve coupling are used in IF amplifiers:—

- (a) Resistance-capacity with series inductance. The upper frequency limit of response is about twice that obtained without the inductance. This type of coupling is not used in commercial re-

generally with capacity coupling of the tuned circuits.

The cathode-ray tube generally used requires some 10-20 volts input for modulation, but in projection types it may be as high as 40 volts. Owing to the low impedance of the couplings necessary to obtain the required band-width, it is quite difficult to secure output voltages of this order, and there is little uniformity in design. Rectification is sometimes carried out in the CR tube itself, but this is not advisable on account of the inefficient operating conditions.

Full-wave detection immediately before the CR tube demands a large output stage, and this is then the last IF valve. The detector can, of course, be followed by a VF stage which makes an efficient output stage. If the DC component is to be retained to control the average picture brightness, however, the amplifier must be direct-coupled.

Distortion in television naturally has a different effect than in sound reception, but is due to the same causes. Frequency distortion causes blurred outlines when it consists of a cut-off of the upper modulation frequencies, but uneven reproduction

of large surfaces when it is in the form of a lack of low frequencies. Phase distortion causes "plastic"—a false appearance of relief—while very bad phase distortion gives multiple contours. Amplitude distortion leads to the absence of half-tones.

Frequency and phase distortion are usually closely inter-related, and are unimportant if the drop in response at

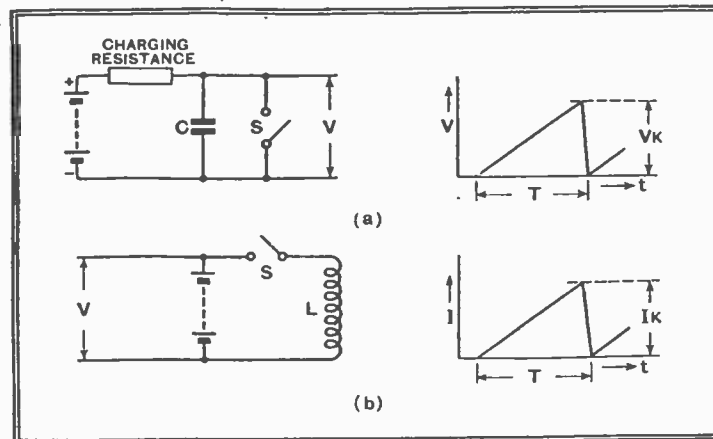

Fig. 1.—The basic circuit for producing a voltage of saw-tooth waveform is shown at (a) and that for generating a current at (b).

ceivers, but is very important in vision-frequency amplification.

(b) Tuned anode coupling. With this system the coupling inductance is tuned by the stray capacities. The circuits may all be tuned to the same frequency or some may be tuned towards the edges of the IF band. More steeply sloping sides to the resonance curve are then obtainable. This system is used in some commercial receivers.

(c) Band-filter coupling. This type of coupling is the most widely used, and

the edges of the band is of the order of 5-10 per cent.

In order to obtain uniform amplitudes of sync pulses—that is, pulses which are affected neither by the picture content nor by the noise level—the small component lying between "black level" and "noise level" must be selected. Several amplitude filters are available. The von Ardenne system embodies a screen-grid valve operated so that its characteristic shows two sharp bends. The valve is biased slightly beyond anode current cut-

Television Reception—

off and operated with an IF input. The Messner filter is operated by the detector output. A valve with a similar characteristic is used, but is biased just beyond the upper bend in its curve. Sometimes a combination of these two methods is adopted and in other cases a diode is employed after the detector.

It is very important that a good amplitude filter be employed, for extreme regularity of sync pulses is required for good operation of the time-base. When using self-running time-bases it is sufficient if the amplitudes of successive sync pulses are maintained within some ± 2.5 per cent., but with externally controlled systems the accuracy must be as high as ± 0.5 per cent.

The necessary voltages or currents for deflecting the cathode-ray beam in accordance with the requirements of scanning are produced by time bases. When electrostatic deflection is adopted a voltage of saw-tooth wave form is required, but with electromagnetic deflection a current of the same wave form is needed.

The fundamental time-base circuit is shown in Fig. 1 (a). A condenser C is charged with a constant current so that the voltage V across the condenser increases linearly with time. When it reaches a predetermined value, which is less than that of the charging source, the condenser is rapidly discharged through a device such as a gas-discharge valve. This is shown in Fig. 1 by the switch S. The discharge time is only about 5 per cent. of the charging time, consequently the discharge current is much larger than the charging current.

With magnetic deflection the current through the coil L (Fig. 1 (b)) corresponds to the voltage across the condenser C in the circuit for electrostatic deflection. In order to obtain a current increasing linearly with time it is necessary that the voltage V of the source be kept constant by a glow-discharge stabiliser. Before the current through L reaches the limiting value determined by the circuit resistance it is interrupted by a circuit-breaking device S. This interrupter can be a low-resistance valve which can be blocked suddenly by the synchronising pulse.

Time-Base Circuits

The usefulness of this circuit is limited at high frequencies by the inevitable self-capacity of the coil L, because a tuned circuit is formed which is kicked into self-oscillation at its natural frequency by the periodical breaking of the circuit. This effect can be greatly reduced, however, by connecting a diode in parallel with the coil in the manner suggested by Urtel-Andrien. The inductance must be so chosen that the half-cycle of the natural oscillation is less than the fly-back time.

Although the deflecting voltage or current is produced in most time bases by the relatively slow charge of a condenser and the fly-back by its rapid discharge, it must be remembered that the conditions can be

reversed. In many cases, merely by a rearrangement of the circuit, the deflecting voltage can be produced by the slow discharge of a condenser and the fly-back by its being rapidly charged.

C is charged through R; when the voltage rises to a certain figure V1 becomes conductive and starts to draw current. This causes its anode potential to fall and a negative pulse to be communicated to the

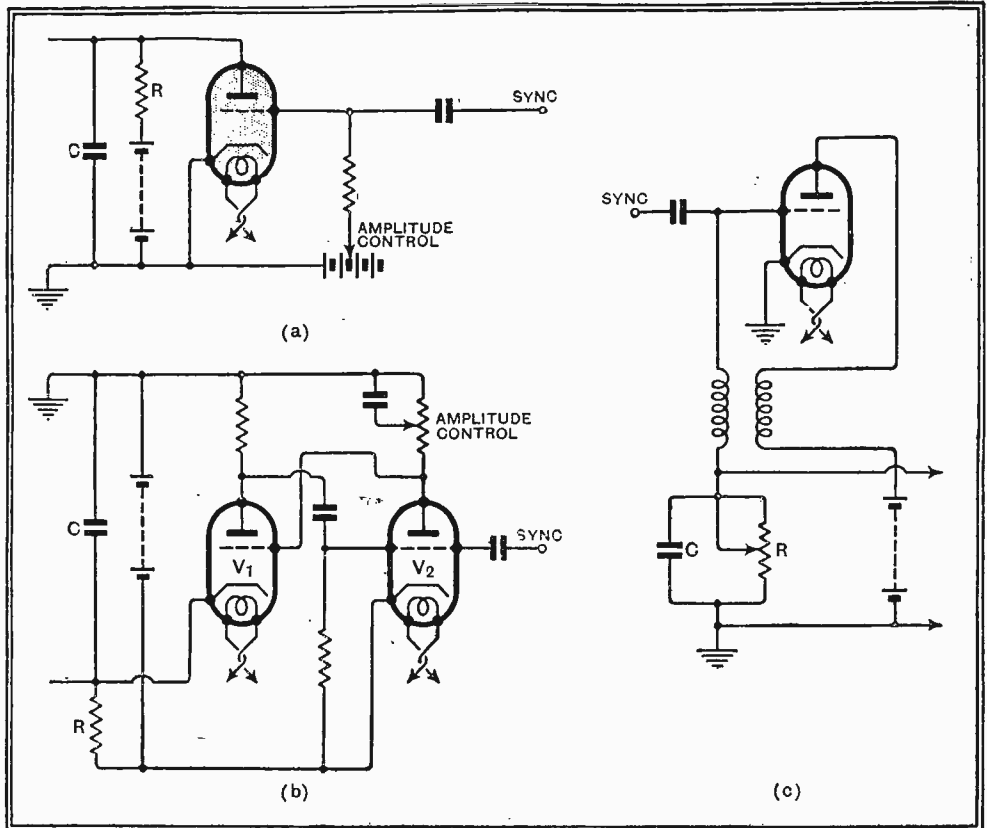

Fig. 2.—The fundamental time-base circuit using a gas-filled triode is shown at (a) while an alternative arrangement embodying two hard valves appears in (b). A single hard valve circuit is given in (c).

When charging is adopted for the deflecting stroke it is important that the voltage shall rise linearly with time. This can be achieved to a close degree by using a saturated diode or a screen-grid valve as a charging resistance. When the voltage source is very high, however, it is possible to use an ordinary resistance and still obtain sufficient linearity. The amount of distortion in such voltages is most conveniently measured by the ratio of the velocities of the spot on the tube at the start and at the end of its path. The highest permissible value for this ratio is 1.1, and this means that when an ordinary resistance is used in the charging circuit the voltage across the condenser must be only some 7-9 per cent. of the voltage of the source.

Two general types of time-base are found—the self-running and the externally maintained. The former is usually adopted, and there are many varieties of this type. One of the most widely used is shown in Fig. 2 (a); the valve is a gas-filled triode and is initially non-conductive. The condenser C charges through the resistance R and when the potential reaches a certain value the valve strikes and rapidly discharges the condenser; it then again becomes non-conductive and the cycle is repeated.

The second time-base (Fig. 2 (b)) employs only hard valves, but two are used instead of one. Here again the condenser

grid of V2, the anode voltage of which consequently rises. This in turn makes the grid of V1 move positively, with the result that the current taken by this valve is increased. The net result is a rapid discharge of the condenser. When the condenser is discharged the series of operations is reversed and V1 becomes non-conductive, so that the condenser C again starts to charge.

An important circuit using only one hard valve is shown in Fig. 2 (c). The time-base condenser and resistance C and R are in the grid circuit of a low- μ triode, the grid and anode circuits of which are coupled together by the coils, so that it is really an oscillator. In operation the valve oscillates and draws a heavy grid current which charges the condenser C, and hence the grid potential becomes negative. When operating correctly the valve becomes biased so heavily that it stops oscillating; the condenser then discharges through R until the grid potential falls sufficiently to permit the valve to start oscillating again.

It will be observed that in this case it is the slow discharge of the condenser which provides the steady sweep for the tube, and the rapid charge which provides the fly-back. The fly-back time depends on the resonance frequency of the oscillator coils. In many cases it is necessary to follow this circuit by a special amplifier in order to correct for the exponential

Television Reception—

change of voltage across the condenser C.

With the second class of time-base—the externally controlled type—the functioning of the time-base is entirely dependent upon the synchronising signals. It does not work at all in the absence of such pulses. The circuit adopted is identical with that of Fig. 2 (a) save that a hard valve is used instead of the gas-filled triode. The condenser C is charged through R in the usual manner and is discharged through the valve when a synchronising pulse makes the grid positive. The advantage of this arrangement is that there are no critical adjustments to make. The disadvantage is that it is necessary to have an exceptionally good amplitude-filter, for extremely regular synchronising pulses are required.

When electrostatic deflection is employed a balanced output is necessary from the time-base. The most usual method of obtaining such an output is through the use of a resistance-coupled push-pull amplifier. In some cases, however, it has proved possible to employ a push-pull transformer for feeding the deflecting plates.

Very careful design of the transformer is necessary, however, for the saw-tooth wave form which it must handle necessitates a response characteristic free from frequency and phase distortion over quite a wide band of frequencies. When the fly-back time is about 5 per cent. of the charging time, the transformer must have a flat characteristic from the fundamental time-base frequency to at least ten times this value.

is very desirable and satisfies the customer.

The views expressed by Mr. Fairbairn in his letter published in your issue of March 19th coincide with my own, and I believe that implicit honesty with efficient and guaranteed work form the basis of satisfactory service.

C. A. HEMMERDINGER,
Partner, Holiday and Hemmerdinger.
Manchester, 3.

Recording

I HAVE read the various articles on sound recording in the recent special issue of *The Wireless World* with particular interest, and am sending you a recording made by me on a Simplat disc, which I should be glad if you would try over. The disc was cut with a Simplat cutter, using a sharp-pointed sapphire stylus.*

As one with some years' practical experience in disc recording and amplifier design, I am surprised to notice the complete lack of all data relating to microphones suitable for recording purposes.

In my experience the microphone is a most, if not *the* most, important part of the whole equipment, and one's troubles only really begin when recording from microphone. Radio recording is comparatively simple. The curves given in Mr. Leever's article appear to be based on a pure input to the recording amplifier, a state of affairs seldom, if ever, met with when using standard-type microphones. This, then, would surely tend to alter very much the overall characteristics of the system as shown in Fig. 3 of that article. Generally speaking, a carbon microphone is not suitable for recording, more particularly if using a disc coated with a gelatine compound, as the background hiss may be in excess of that of the disc itself, always assuming the latter to be properly cut. Of other microphones tried, the velocity type seems to come out best, but, personally (although I must admit those tried have been of foreign manufacture), they leave much to be desired when used in a small studio, and have many disadvantages. I have found by trial that the ideal microphone for the home recordist is the Rothermel-Brush Piezo-Electric Type D.104. This is a diaphragm-type model, and has an admitted peak round about 4,000 cycles, which almost coincides with that shown in the diagram referred to above, giving an accentuated peak at this frequency. The curve would thus appear to be misleading. It is most important when using this microphone to design carefully the associated amplifier in such a way as to balance out this peak; otherwise, the resulting recordings will be shrill and hard. My recordings, judged aurally, would appear to show that I have succeeded in doing this.

I should be exceedingly interested to learn the views of other readers with experience.

E. I. HOWLETT.

North Harrow.

"Volume Expansion"—A Correction

IN Fig. 2 of Mr. Laurence Snell's letter, published in our issue of March 26th, a condenser should be interposed between the anode of V1 and the output circuit. The purpose of this condenser (which may have a capacity of 0.1 mfd. upwards) is to prevent the application of a DC potential to R and VR.

* The record is a very good example with very low surface noise.—Ed.

Letters to the Editor

Horn-Loaded MC Speakers

AS an enthusiastic devotee of high quality reproduction of sound I beg to respond to the letter by Mr. Barden included in the issue of *The Wireless World* dated March 19th.

The doubt immediately assailed me on reading this gentleman's letter whether he had ever heard Mr. Voigt's domestic speaker.

Although formulæ are naturally essential for the practical working of any science, I think there is no doubt that the ear is the ultimate critic of reproduction. As far as my experience goes, the only flat baffle that did not introduce some sort of coloration, especially in the bass, was a brick wall, and for a considerable time I thought this was to be the final position of my speaker, as it provided, of course, practically an infinite area.

Having heard, however, a good deal of discussion about the horn loading of domestic loud speakers, I decided to go to a Voigt demonstration—I might say, with no little intention of "picking flies." My surprise and admiration may be imagined when I found that the glove was very definitely on the other hand, and, as a result, I came away a thorough convert. The bass reproduced by the speaker, which appears to be Mr. Barden's chief item of attack, was far more real than any baffle speaker I have heard, and, moreover, did not contain any disagreeable resonance.

The suggestion made by Mr. Barden of attaching the speaker to a flat baffle placed at right angles to a wall at the point where the baffle meets the floor would, admittedly, give a larger baffle area, but in so doing would project the high-frequency ray where it was least required.

The Voigt h.c. corner-horn which I now use gives a very even distribution of the top, complete absence of the effect that the sound is radiating from a definite spot, and although there is no bass chamber, a 50-cycle note (direct from mains via transformer to speech coil) differs very little from that produced by the same speaker set in the wall. The speaker, incidentally, is a Hartley-Turner twin cone, which, I think, everyone will agree, goes well below 50 cycles.

Finally, then, in view of this, added to the increased efficiency and improved psy-

The Editor does not hold himself responsible for the opinions of his correspondents

chological effect, I would like to offer my humble opinion that, with all respects to Mr. Barden, horn loading is definitely superior to that provided by flat baffles. I have found, moreover, that this is not only my view, but that of nearly all the critical quality enthusiasts with whom I have come in contact.

This opinion is entirely independent, and the writer has no connection with either of the firms mentioned.

Walsall. A. A. COTTRELL.

Service

I HAVE read with interest the comments of your contributor "Diallist," in the issue of March 19th, on the question of service.

The Editor's interpolation regarding the suggested fixed fee of 3s. 6d. for testing a set and locating a fault seemed particularly apt.

I have no doubt that retailers may find it a satisfactory solution of their service worries to be able to quote a fixed nominal charge to their customers. This low figure may be used as a sales-aid, and may often at a later date prevent the alienation of the customer's goodwill. In this case service is being used as a subsidiary to the primary business of set retailing. Where repairs are executed by those who are solely engaged in repair work and who give a guaranteed job this figure is inadequate.

I feel, however, that the extension of this practice to pure radio servicing is strongly to be deprecated as it inevitably results in small faults being over-charged and vice versa. Surely it is not reasonable to make the same labour charge for a set needing a new resistor and for a set needing the mains transformer rewound and a new condenser bank fitting.

Where an estimate is desired this should be given in full detail, showing the new parts required and the parts that need repairing or adjusting. The invoice should give full details of work done, together with the respective charges for labour and parts. The practice of returning all parts removed

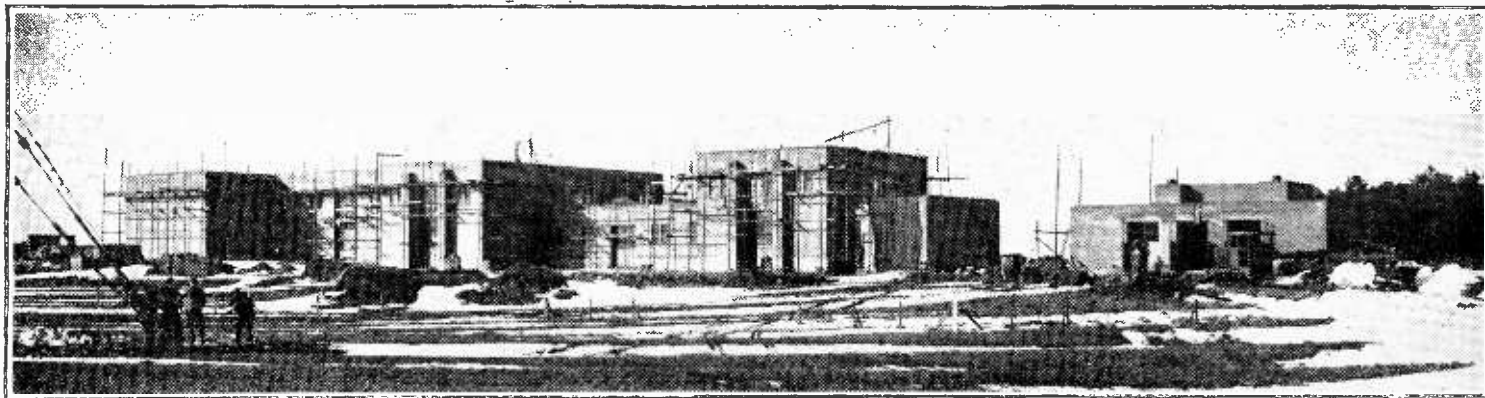

IN THE MAKING. Progress continues to be made with the erection of the North-east Regional Station buildings at Stagshaw, near Newcastle.

BROADCAST

NEWS FROM PORTLAND PLACE

Coronation Television

THE Coronation procession will be televised from Apsley Gate, Hyde Park Corner.

Although H.M. Office of Works has not seen fit to permit more than one television camera point, it is understood that the B.B.C. will make the most of the available opportunity to give as comprehensive a view of the procession as possible. To this end telephoto as well as ordinary lenses will be employed to provide close-ups of the Royal Coach and other highlights.

Cable or Radio Link ?

It has not yet been decided whether to use the co-axial cable for the Coronation relay or to rely on the ultra-short wave link with Alexandra Palace. Probably an attempt will be made to have both systems available . . . just in case.

Within the next few days work will begin on the erection of a receiving aerial above the existing sound and vision arrays at the television transmitter.

Fanfare Beneath the Dome

IF rich acoustic effects can add splendour to a musical occasion, there will be a grand climax to the "Service in Preparation for the Coronation," to be broadcast at 8 p.m. on Sunday, May 9th. The service itself will be held in the Concert Hall at Broadcasting House, but the final hymn, the National Anthem and a Solemn Fanfare will be broadcast from under the dome of St. Paul's Cathedral. Here will be assembled members of the Coronation Choir, together with delegate singers from the Dominions, Scotland, Wales, Ireland and London.

"The Royal Anointing"

The Archbishop of Canterbury will give the Address, while the Invocation and Hallowing will be said by the Rev. F. A. Ire-monger, M.A., Chaplain to the King and B.B.C. Director of Religion. To make the service as widely representative as pos-

sible, it has been arranged that Thanksgivings shall be said by the Rev. M. E. Aubrey, M.A., Moderator of the Federal Council of Evangelical Free Churches, and Prayers by the Right Rev. Professor Daniel Lamont, D.D., Moderator of the Church of Scotland.

Very old texts will be used in the service, including "The Royal Anointing"—a greeting addressed by the Bishop of Lincoln to Henry III in A.D. 1246. "The King's Prayer," which will also be said, dates from the year 1382.

Three Hours of Coronation Dance Music

LONDON and the provinces are to be "tapped" for dance music on Coronation Night. Nearly three hours of rhythm will be radiated, beginning at 10.15 p.m., when Henry Hall and his boys strike up at Maida Vale. Thence we shall be transported to Belfast, and afterwards, with intervals at Maida Vale, we shall "visit" Blackpool, Birmingham, Swansea or Cardiff, and Torquay. Stations close down at 1 a.m.

Coronation Numbers

Dance bands broadcasting during Coronation Week include those of Roy Fox, Joe Loss, Billy Cotton, Ambrose (from the Royal Albert Hall) and Jack Payne (from Grosvenor House).

And every band will be broadcasting a special "Coronation" number.

Manchester Linked with Glasgow

EVERY quarter the B.B.C. Engineers issue to Departments concerned a special map of the British Isles showing the "S.B." lines linking the various stations. As time goes on the network grows more complicated.

BREVITIES

The April map, just issued, shows a new direct link between Manchester and Glasgow, with provision for two-way simultaneous working. Glasgow, in fact, can now enjoy Gracie Fields in her native county while Manchester revels in bag-pipe music. For six and a half hours each day the engineers also have the use of a Post Office telephone line over this circuit for check purposes.

The Strongest Link

The biggest number of lines are between London and Daven-try, which can simultaneously exchange three programmes each way. There are also numerous telephone lines permanently available for engineers' use.

Stagshaw: The Latest

SKILLED labour is again skil-fully labouring at Stag-shaw, where work on the North-East Regional was recently held up on a little question regarding the contents of pay envelopes. No one doubts now that the station really will be working by the autumn.

Architecturally, the station follows Regional practice; in fact, it is only in the use of a single mast aerial that it differs radically from its prototype at Brookmans Park. Hats should be lifted to Captain Peter Eckersley, the B.B.C.'s first Chief Engineer and originator of the Regional scheme.

Hopeless Dawns

ABOUT two hundred scripts and lyrics — are submitted weekly to the B.B.C.'s Light Entertainment Department. Of this huge output only about one quarter per cent. is found suitable for broadcasting.

In other words, 59¾ per cent. of would-be radio writers live bitter lives.

Topicality Wins

How to change all this is indicated by Max Kester and Edwin Collier in a sprightly little book, "Writing for the B.B.C." Sketches, preferably humorous, are in big demand, provided they do not play for more than fifteen minutes. The most popular run to three minutes. Topicality is the quickest means of securing acceptance, provided you are first with the idea, but it has to be remembered that every new topic of importance is seized upon by all the humorists in the land. Towards the end of 1934, as a case in point, Belisha Beacons sprang into being, and immediately the Light Entertainment Department was deluged with Belisha jokes and sketches. One in four hundred was accepted.

Do's and Don'ts

The authors plead with writers not to attempt to put scripts into technical broadcasting form. The B.B.C. experts will gladly do this work if the basic idea is good.

The book closes with the pathetic plea that writers should read over their material before submitting it. If they all did so, fewer scripts would be submitted.

Televising Television

TELEVISION will shortly be televised. The idea is not so crazy as it sounds, for the intention is to take viewers on a screen tour of the B.B.C. wing at Alexandra Palace. The camera will first be taken to the vision transmitting hall; then by easy stages the sound transmitter, dressing-rooms, make-up department and wardrobe will come into the picture. By way of a finale the camera will move slowly along the main corridor till the studio is reached just in time to televise the televising of a variety show. If another camera then began to televise the televising of the televising . . . the idea is too disturbing.

Marconiphone

MODEL 395

An All-wave AC/DC Radiogramophone
with Record-changer

THE listener who is not on AC mains or who may be contemplating a move to a district where his supply will be of a different nature has a fairly wide choice among table model receivers, but hitherto he has not been too well catered for if his requirement is a full-sized radiogramophone.

The Marconiphone Model 395 should go far to solve his difficulty, for it is a solidly constructed instrument and of impressive appearance. The up-to-date radio chassis includes a short-wave band and the gramophone equipment includes an automatic record-changer. As far as the radio chassis is concerned this is self-adjusting for direct or alternating current supplies between 200 and 250 volts and 25-60 cycles, but an adjustment is necessary before the instrument is put into operation.

The aerial circuit is suitable for normal single-wire elevated aerials or special aerials of the anti-interference type, and comprises a single tuned circuit on the short-wave band and a band-pass filter with "mixed" coupling on the medium and long waves. A triode-hexode frequency changer is the first valve in the circuit and its output is amplified by a

FEATURES.—*Type.*—Radiogramophone with record-changer incorporating three-waveband super-heterodyne chassis. **Waveranges.**—(1) 16.5-50 metres. (2) 200-580 metres. (3) 750-2,000 metres. **Circuit.**—Triode-hexode frequency-changer—var.mu pentode IF amplifier—double-diode second detector—pentode output valve. Half-wave valve rectifier. Barretter current regulator. **Controls.**—(1) Tuning. (2) Combined tone and volume. (3) Wave-range. (4) Radiogram. switch. (5) Mains on-off switch. **Price.**—33 guineas. **Makers.**—The Marconiphone Co., Ltd., 210/212, Tottenham Court Road, London, W.1.

single pentode IF amplifier. This is followed by a double-diode second detector which also supplies delayed AVC to the first two stages in the set. The output from the second detector is very thoroughly filtered and passed through resistance coupling without amplification to the high-slope pentode output valve. A transformer is associated with the gramophone pick-up and serves the dual purpose of completely isolating it from the

chassis and giving some voltage step-up to take the place of intermediate amplification before the output stage. There is a three-stage tone control consisting of condensers shunted across the output circuit and a switch is provided which enables any desired combination of the internal and external loud speakers to be obtained. Damage to the output pentode is guarded against by a ballasting resistance across the external loud speaker terminals, which prevents the volts

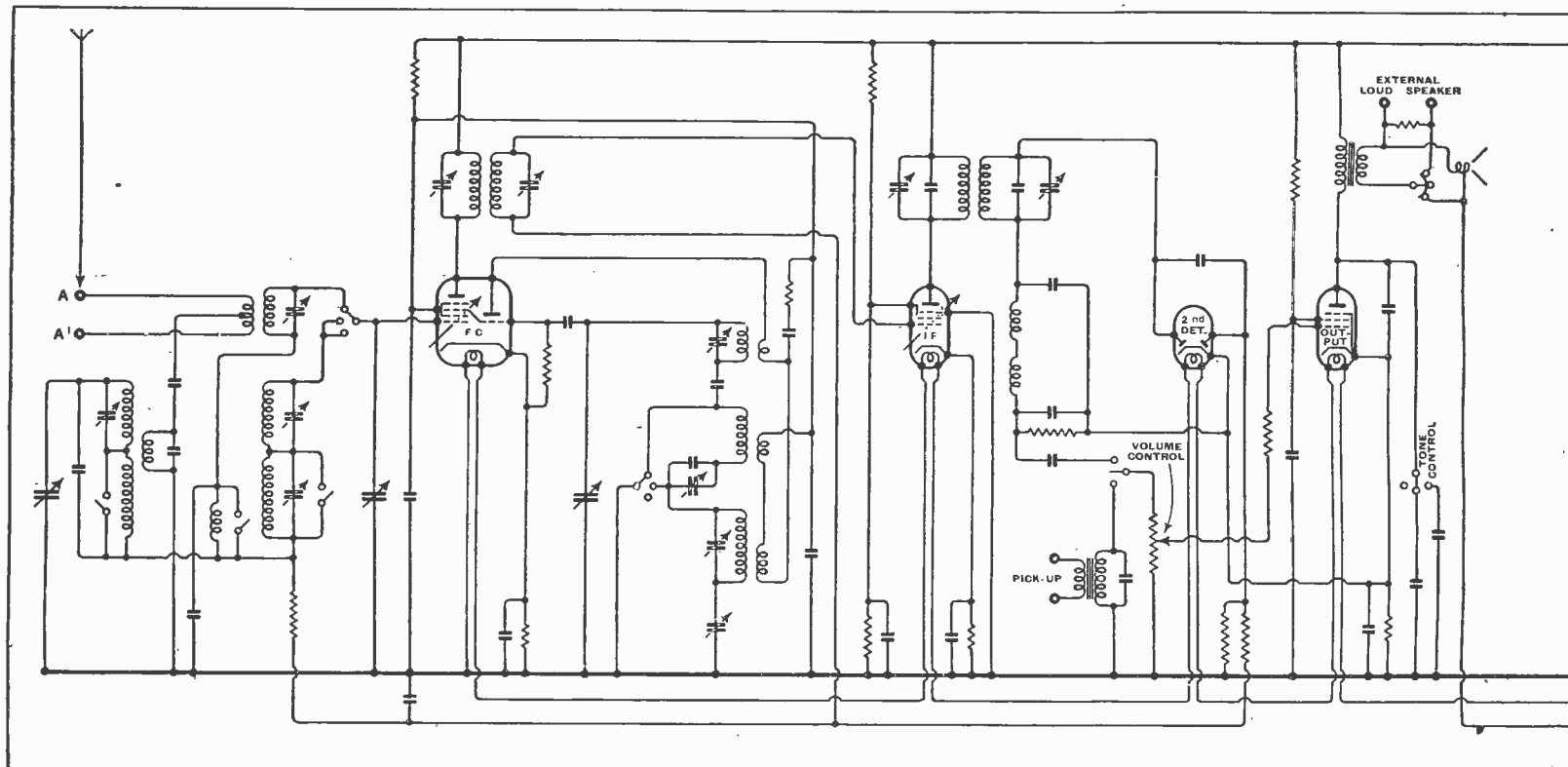
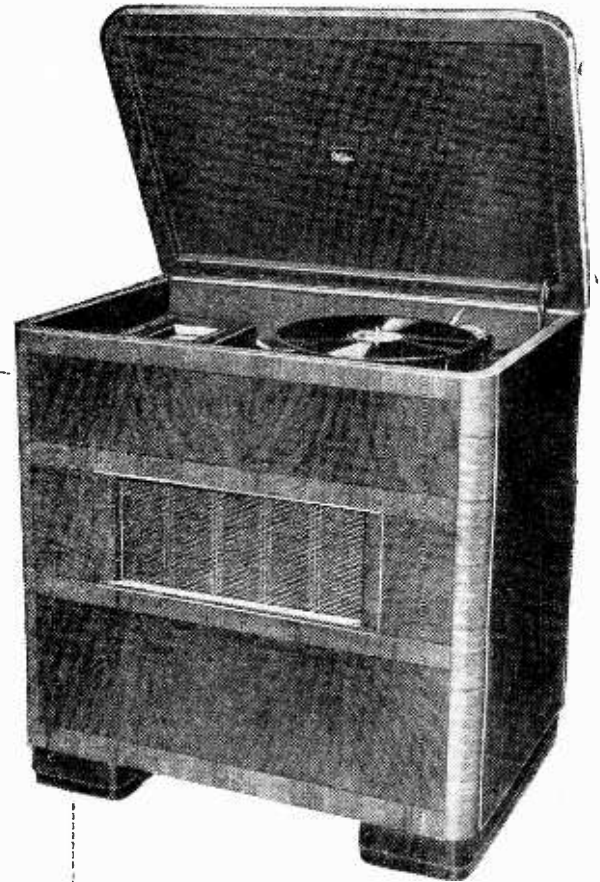

developed in the anode circuit from rising unduly should the switch be put into this position when no external loud speaker is connected.

The HT supply is derived through a U30 rectifier with the elements connected in parallel, and a barretter lamp is connected in series with the filaments to hold the heater current constant. Both the mains and the connections to the gramophone motor carry HF filtering chokes and each mains lead is supplied with separate fuses and switch contacts.

A high over-all magnification is not to be expected in a circuit of this type, but it is nevertheless quite adequate, and has this advantage, that the loud speaker is never overloaded. The balance of volume as between radio and gramophone is well kept, and, while ample power in keeping with the size of the set is obtained, it is virtually impossible to produce overload distortion in either case.

The elliptical loud speaker has an excellent bass response and gives wide angle distribution of the high tones, which are present in just the right proportion. Needle scratch is hardly noticeable, and yet the full high-note range can be used except under con-

ditions of unusually bad interference on the short-wave range.

Although the over-all magnification is not more than is necessary, no reduction has been made in the amplification of the earlier stages in the set upon which the sensitivity and range depend, and the receiver gives an excellent account of itself in bringing in distant stations both on the normal broadcast bands and on the short waves. W2XAD and W3XAL were received at a comfortable strength and there was a generous choice of Continental broadcast programmes during the

switch is rather unconventional and is operated by a lever working through a slot in the panel. Separate rotary switches are provided for changing from radio to gramophone and for switching the set on and off. The tone control is combined with the volume control and is matched by a similar concentric pair of knobs giving fast and slow movement to the tuning dial. A particularly lucid tuning scale has been provided in which the three straight scales run parallel on a translucent white illuminated background. The scales are over 8in. in length and

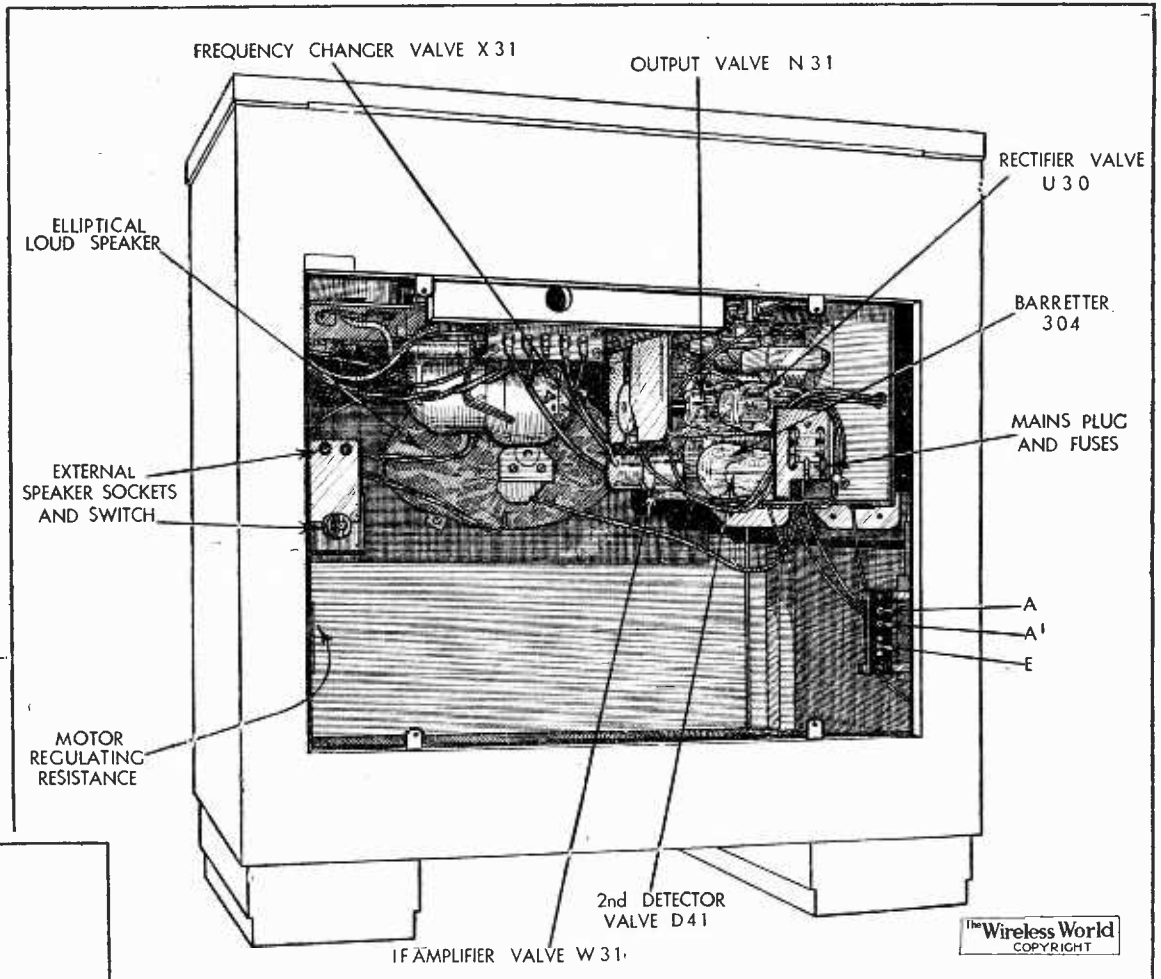

Rear view of the Model 395 with back panel removed. Note the three-position loud speaker switch and the accessible placing of the fuses.

are calibrated with station names on the medium and long waves.

With the motor resistance adjusted according to the instruction book the power appeared to be just sufficient to prevent slowing of the turntable during loud passages, and it was noticed that the turntable speed was to some extent dependent upon the setting of the regulating resistance as well as upon the external governor control on the top panel. In changing from one supply to another, therefore, the motor speed should be checked and corrected, if necessary. The chassis is mounted against the left-hand side panel of the cabinet which can be removed for inspection of the under side of the chassis. The mains plug is devised so that the back panel cannot be removed without disconnecting the supply and the fuses are accessibly placed adjacent to the mains plug. In sets of this type it is to be expected that more

hours of daylight on medium and long waves.

No second-channel whistles of any serious consequence are to be recorded and the selectivity enabled clear reception of stations spaced by more than one channel from the local stations to be obtained when using the set at a distance of 15 miles from Brookmans Park. The strength of the Deutschlandsender was excellent, but full use had to be made of the tone control to bring the sideband interference from Droitwich and Radio Paris within reasonable bounds.

All the controls are situated on the left-hand side of the motor board under the lid of the cabinet. The wave-range

No amplification is provided between the second detector and output stages, but the sensitivity is good and the over-all magnification is sufficient to give the full power output on all worth-while stations.

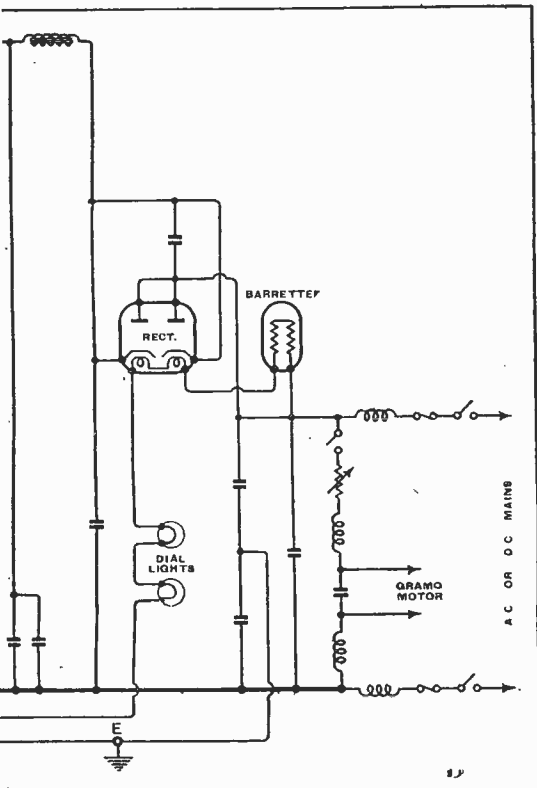

Marconiphone Model 395—

external heat is developed than with pure AC receivers and it is gratifying to note that every possible precaution by means of deflectors, etc., has been taken to ensure that this shall not interfere with the future reliability of the instrument.

To sum up, the Model 395 provides all

that one can reasonably wish from the point of view of entertainment either from radio or records with an economical circuit specification, which has this great advantage, that it provides a set which is extremely docile to handle and is virtually incapable of producing distorted results.

An Extra Valve ?

I'M wondering what improvements we shall see in this year's medium-priced sets, by which I mean those within the £12 limit. It's likely that there'll be many much cheaper sets incorporating simple three-valve superhet layouts; there will also be a fair sprinkling of sets selling at £20 and upwards. But the £12 receiver is sure to remain popular, for that is the kind of price that people have got used to paying. Some of these will no doubt contain signal-frequency stages. Every year production costs are lowered by the adoption of more and more scientific methods of manufacture. In 1937 it may therefore be possible to throw in an extra valve at the old price. If it is used for signal-frequency amplification it will mean greater sensitiveness as well as a reduction of "images" and self-generated whistles. But it may, of course, be employed for other ends. Some designers may plump for its use for ATC purposes; others may feel that the growing demand for better quality justifies its use on the low-frequency side of medium-priced sets.

RANDOM RADIATIONS

A Spate of Sets

SINCE the beginning of this year over one hundred and twenty new receiving set models have made their appearance on the market! Only a year or two ago all the new sets came along at the time of the Exhibition or just afterwards, and from Christmas until August novelties in receiving sets were almost as rare as water in the Sahara. The present policy of manufacturers is in many ways a good one. People are ceasing to think that they must wait till the Radio Show before replacing their old sets, and from this it follows that employment in the radio industry is becoming less of a seasonal affair. But I'm not quite sure that we aren't overdoing it a bit in the way of new types. A hundred and twenty in the first three months of the year is a pretty useful number—and it's not at all unlikely that there'll be a good few more between now and the Coronation. The vast majority of the sets that have so far seen the light this year are variations on the old theme of how to get rather more than you really ought to get out of three valves; but I note with joy that some bigger sets are amongst them.

News Out of Spain

SOMETIMES when you've been indulging in a little knob-twiddling in the medium and short wave bands and have been listening to copious news out of Spain from both Franco and Government stations it's rather disappointing to hear the B.B.C. report in its news bulletins that there is little or nothing to tell of happenings in that country. Myself, I find Spanish news direct from Spain of great interest. Not the smallest of its interest is to make a list of the victories, captures, advances and so on claimed by one side and then see how many of these are categorically denied by the other. The B.B.C. must be able to tap these news bulletins by way of Tatsfield. I suggest that they give us occasional samples of the way in which both sides are defeated and both victorious in the same battle. If the B.B.C. won't do so, the owner of a wireless set worthy of the name can always tune in Moscow and Rome and derive no little diversion from their commentaries in English on the Spanish news. I can assure you it's well worth while!

Impropaganda

ONE of the most amusing ways of wiling (I am not dropping an "h"; I maintain that the word is wiling and not whiling), of wiling away an hour with the wireless set is to tune in stations in some of the rather more deadly earnest countries whilst they are giving their talks and news in English. Whatever command their announcers may have of our queer language, it becomes almost instantly obvious that those who write what they have to read have very little familiarity with our

By "DIALLIST"

still queerer mentality. Most of us are only faintly interested in politics—foreign politics, anyhow. You can't listen long to one of these propaganda talks without feeling pretty sure that it can cut absolutely no ice with British listeners. Hence, though your blood may occasionally display a tendency to boil at some of the things that are said, there is no need to get hot under the collar. The impropropaganda talks are mostly too comic for anyone to take them seriously, unless he is totally bereft of a sense of humour. I, for one, am glad that we have adopted a policy of not answering back.

Les Mots Justes

IF you listened, as no doubt you did, to Professor Appleton's recent talk on Sunspots, you must have been struck by the peculiar aptness of one of his similes: "As the sunspots increase," he said, "there is a greater tendency for the sun to send out both bursts of ultra-violet light and swarms of flying atoms. When these reach the higher atmosphere the reflecting properties of the layers are impaired. It is like breathing on a looking-glass. I can't imagine any words that could have given the man in the street a clearer idea of the effects produced by the Heaviside and Appleton Layers on long-distance wireless reception and of the influence that outbreaks of sunspots have on them. A good many years ago H. G. Wells wrote that no department of human learning had more vital messages to give to humanity than science, but from sheer inarticulateness no department was less able to convey them. Men like Appleton, Bragg and Jeans have taken up that challenge and we are fortunate indeed in having them to put difficult things into such simple but vivid words that all who read or listen may understand.

America Predicts

Speaking of sunspots reminds me that the astronomers of the Mount Wilson Observatory in California, who make rather a speciality of solar work, predict that we are shortly to witness one of the biggest outbreaks of sunspot activity that there has been for a century or more. Though there's still about a couple of years before the maximum is due we have already had some pretty useful manifestations; twice in recent months there have been sunspots easily visible to the naked eye, or, rather, the eye protected by a screen of smoked glass. If something still bigger and still more spectacular is to be expected we can be fairly sure that there will be some weird radio happenings. As it is, we have had some remarkable instances of short-wave and ultra short-wave reception over vast distances. No one can say what further wonders are in store as we approach the maximum period, reach it and begin to leave it behind us.

Sets for All Purposes

The fact that there are at least three different uses of an extra valve to improve the performances of what has become virtually the standard superhet in this country which jump to the eye gives one to think a bit. It means that any such set could become an altogether better thing if it had three extra valves; if, in other words, the superhet in general use contained six valves in addition to the rectifier instead of the now almost traditional three. Probably it would be impossible to market such a receiver, even with modern mass-production methods, at a price of £12 or so; but in view of its really superior performances couldn't the public be educated up to regarding a set at about £15-£18 as the normal medium-priced receiver? I think it could. We'd then have this very satisfactory position. For the man with a short purse who wants a reasonably good set there'd be the receiver at about £9, capable of bringing in home stations and a good many foreigners on the long, medium and short waves with acceptable quality; a far higher standard would be reached by the set priced at about twice as much, and for those who want the best there'd be the receiver with a dozen valves or more, costing from £25 to £40.

Making It Easy

IN the old days of wireless, when the operator of a receiving set had to possess a certain amount of skill, we had a vast array of knobs and switches on the panel and quite simple circuits within. It's almost axiomatic that the more you simplify your visible and tangible controls the more you must complicate the unseen "works" of a wireless set. So long as the average operator was skilled there was no need to make sets foolproof; but now that the great majority of sets are handled by folk who neither know nor want to know anything at all about what happens when you do this or that with a knob it is of paramount importance that in every possible way the correct tuning and the best quality of reproduction should be attained automatically. If manufacturers will realise these things and stress them, they shouldn't have much difficulty in showing the man in the street that the set that sells at a pound or two more is worth every penny of its extra cost. Will they do so? I hope that they will.

UNBIASED

By FREE GRID

War-time Recollections

I SEE in my daily paper that the great *caravanseraï* which cross the Sahara desert are now fully equipped with wireless so that they can keep in touch with civilisation during their journeyings. Reading about this has taken my mind back nearly twenty years when during the war I and some fellow scientists, at the special request of the Government, undertook the pioneer work of fitting the ships of the desert with wireless.

It was during 1917 when the German submarine campaign was at its highest, more especially in the Mediterranean, which was a veritable lions' den. In order to circumvent the enemy, the Government arranged that all ships bound for the Near-Eastern theatre of war should discharge their cargoes on the west coast of Morocco, to be transported from there to Egypt across the great Sahara and Libyan deserts by means of camels. Unfortunately, a great deal of loss and confusion were caused by the fact that the ships' officers who were put in charge of the camels were totally lacking in experience in the matter of desert navigation, with the result that frequently convoys of camels were unexpectedly turning up in Sierra Leone or Cape Town instead of Alexandria. Naturally this tended to dislocate the plans of the Allied High Command and added materially to the undue prolongation of the war.

Eventually it occurred to somebody at the Admiralty that if each camel were fitted with a complete wireless installation it would enable them to keep in touch with each other and with the various "land" stations on the north coast of Africa. I and my fellow scientists were immediately despatched to Egypt to commence the necessary experimental work and quickly had the first few camels fitted with suitable sets. Incidentally, I have dug out an old photograph which I reproduce herewith showing myself (stern view) adjusting one of the sets.

We were troubled at first by the lack of a suitable earth, the desert being notoriously dry and therefore entirely unsuitable. By a tremendous stroke of luck, however, one of the members of my staff recollected learning at school that camels carried water in their humps, and we at once got the Royal Army Veterinary Corps to operate on the animals and insert silver plates inside the humps in order to make good contact with the water. Even so, however, results were exceedingly poor, and we could not think what could be the cause of the trouble. We felt that we were on the right track, however, for after all if an ordinary sea-going ship uses water very successfully as an "earth" why should it not be equally suitable for a ship of the desert?

We were at our wits' end to know what to do when somebody remembered that sea water is salt, whereas it is fresh water camels store in their humps. Needless to say, this little difficulty was soon remedied by arranging to provide the camels with salt water at all the filling stations—or oases, to use the old-fashioned name—in the desert. Immediately this was done we got

really snorting results, and were just about to fit the entire fleet of camels with sets when we received a telegram to say that the war was over and ordering us to return home immediately.

To be strictly truthful, it was in 1922 that we received the telegram. We had been astonished in the midst of our labours to find among the many tourists who came out from Cairo to gaze at us and our "shipyard," several parties of Germans whom we very promptly made prisoners-of-war. It was in reply to our despatch reporting this that we received the telegram. The Admiralty department concerned had apparently forgotten all about us, although it must be placed to the credit of the Government's watertight departmental system that our salaries and supplies had continued to arrive regularly.

Per Scientiam Ad Astra

I AM one who never believes in taking anything for granted, and I am always chary of accepting other people's state-



Experimental work in my bathroom.

ments until I have proved their truth or otherwise by scientific experiment. Consequently, when I read the other day a statement by "Diallist" to the effect that

Self (right) and Camels.

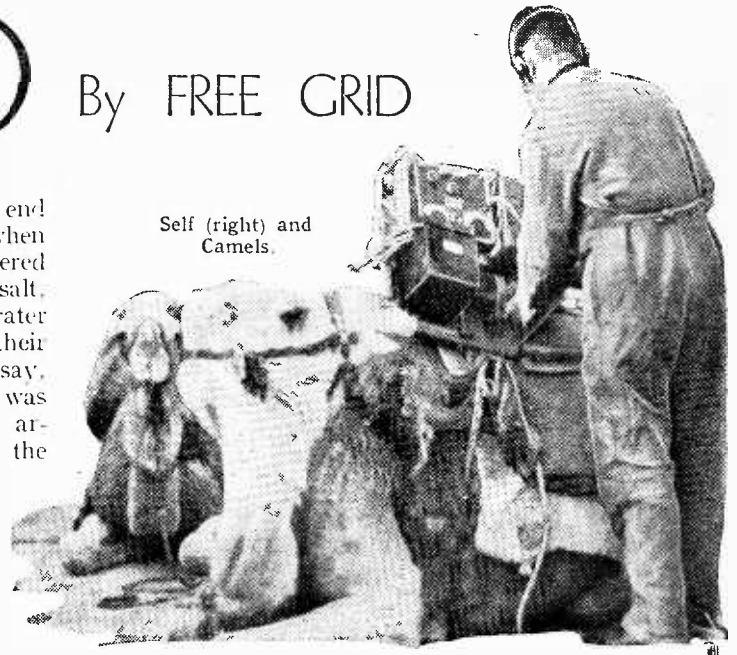

the resistance of the human body was astonishingly low after a hot bath, I determined not to accept it as true without experimental verification. Indeed, I may say that my whole soul rose in revolt at the statement, which was manifestly untrue.

The way I argued it out was this. Under normal conditions the pores of our skin are clogged with—pardon me, ladies—the natural exudations consequent upon the exercise of our daily functions, or, to put it in less scientific language, perspiration. These exudations are largely composed of *sodium bisomethingorother*, or, in other words, are salty.

Now saline liquids are, as every school-boy knows, very good conductors of electricity, far better than ordinary fresh water; it follows, therefore, that, in the normal state, the contact resistance of our bodies is extremely good, so that if we become connected in an electric circuit we receive a severe shock. The effect of a bath—even a cold one—is to cleanse our pores of these salty exudations, and to substitute fresh water, with the result that the contact resistance of our bodies rises considerably. In the case of a *hot* bath the cleansing effect, as everybody knows, is much greater, and therefore it follows logically that the contact resistance of the body is proportionately higher. Bathing, should therefore be regarded, not as a danger, but as a precautionary measure to be taken by all who dabble with high voltages.

These elementary physiological facts form, I think, a convincing argument against the veracity of "Diallist's" rash statement; but, as I have previously remarked, I never accept anything without experimental proof, and so I am proposing to carry out an elaborate series of tests in my bathroom. Should it so happen, therefore, that my usual contribution does not appear in next week's issue of *The Wireless World* you will know that "Diallist's" statement was correct after all.

TO hear the Prime Minister broadcast twice in four days is an unusual experience for listeners. This will, however, occur during the next week, the first occasion being on Tuesday, when he will speak at the dinner given in his honour at Grosvenor House, Park Lane, by the Federation of British Industries. His speech will be broadcast in the National programme at 9.20. On Friday, April 16th, he will be the first speaker in the new series of important broadcast talks on "The Responsibilities of Empire." In this series he will be followed by many famous statesmen within the Empire,

Listeners' Guide

Outstanding Br

broadcasts may be introduced, and telephone calls will enable well-known people in Europe to take part. The feature will be broadcast at 7.30 (Nat.), produced by A. W. Hanson, who has been responsible for "In Town To-night" since its inception in October, 1933.

compiled from the actual ship's log by Alexander Bone, the well-known nautical writer.

FIRE WALKING

AN unusual type of O.B. comes to Regional listeners today (Friday). At Carshalton, Surrey, the University of London Council for Psychical Investigation is to see a demonstration of fire walking by Ahmed Hussain. Although this seems much more fitted for a television O.B. than a

"THE FIRST DAYS OF STEAM"

THE Atlantic was crossed under power for the first time nearly a hundred years ago—

abroad. Last week Duncan White and his orchestra opened the series. On Wednesday at 7 (Nat.) Willy Lewis and his Negro Band will be heard from Paris. Other famous Continental bands to be heard include Kai Ewans from Stockholm, the Ramblers from Holland, and the Quintette du Hot Club de France.

PIANOFORTE

RAWICZ and Landauer, the well-known pianists, will give a recital for two pianos on Sunday at 4 (Reg.). Their programme will include an arrangement of Tchaikovsky's "Nutcracker Suite."

The Sunday Orchestral Concert which will be broadcast this week at 9.5 (Reg.) will be conducted by Sir Henry J. Wood. The programme includes William Walton's Sinfonia Concertante for piano and orchestra, the soloist being Clifford Curzon.

On Tuesday, Franz Reizenstein will give a recital at 6 (Reg.), during which he will play his own suite for pianoforte. This will be the first broadcast performance.

Solomon will give a recital with Antonio Brosa in the



some of whom will be members of Coronation delegations from India and the Dominions.

A.B.C.

A NEW variety feature entitled "The B.B.C. Presents the A.B.C." will succeed "In Town To-night" as from this Saturday. It has been devised by Alan Keith, the promising young writer, who as an actor is already well known to listeners for his radio performances. On twenty-six successive Saturday evenings, except for Coronation week, one for each letter of the alphabet, the feature will deal with people and things whose names begin with the appropriate letter. Thus the first programme will be introduced by a celebrity whose surname initial is A. The programmes will not necessarily consist solely of talks and interviews. Outside

in April, 1838. Addressing the British Association on steam navigation a month or two previously, Dr. Lardner was voicing popular opinion when he remarked, "As to the project of making a voyage under steam from Liverpool to New York, one might as well talk of a voyage from Liverpool to the moon." The first steamship to set out for New York was the paddle vessel *Sirius*. Built of wood, she carried ninety-four passengers, took nineteen days to make the passage, and had a gross tonnage of 703.

"The First Days of Steam" programme on Sunday at 9.5 (Nat.) will be an imaginary account of that historic voyage

SAVOY MEMORIES is the title of a reminiscent programme of twenty-five years of dance music to be given on Tuesday at 8.10 (Nat.) by Carroll Gibbons and the Savoy Hotel Orpheans. He is here seen with some of the Orpheans during a recent television broadcast. Among those we shall hear in this programme are Debroy Somers, Billy Mayerl and Rex Palmer.

"sound" broadcast, it should be none the less interesting for those who are able to listen in the early afternoon. For a quarter of an hour from 1 o'clock, listeners will be told of the preparations being made in readiness for the walk, then at 2.50 they are to hear a commentary on the walk itself.

SWING

ADMIRERS of the hotter forms of jazz will no doubt welcome the B.B.C.'s decision to give a regular place in the quarter's programmes to "live" swing music. Weekly broadcasts will be given alternately from London and

National programme at 10.20 on Thursday.

SPORTS

FROM 2.30 until 3.15 on Saturday, National listeners will be given a commentary on the play in the final stages of the match at the Queen's Club, West Kensington, between D. S. Melford (Gt. Britain) and N. Setzler (U.S.A.), for the World's Open Racquets Championship. Later in the afternoon the Public Schools Sports at the White City Stadium and the Empire Trophy Motor Race at Donington Park will provide commentaries. At 4 and 4.50 the switch will be put over to

Details of this week's Television programmes will be found on p. 361.

the Week

casts at Home and Abroad

the White City, where H. M. Abrahams will be waiting to tell listeners of the progress of events. At 4.25 and 5.5 Donnington Park will be switched in to allow F. J. Findon and Graham Walker to give commentaries on the Empire Trophy Race of the British Racing Car Drivers' Club.

The heavyweight boxing match between Tommy Farr and Max Baer at Harringay Arena will be described by Howard Marshall for Regional listeners at 9.30 on Thursday.

BLenheim PALACE ORGAN

ON Thursday, at 8, Regional listeners are to hear a Midland programme which is the first of a resumed series entitled "Midland Organs and Organists." The Duke of Marlborough has consented to a recital being broadcast on the organ at Blenheim Palace, Woodstock. A description of the organ will also be included. This, it is hoped, will be given by the Duke himself.

The organ, one of the finest instruments in the country, was

CITY OF BIRMINGHAM ORGANIST, G. D. Cunningham, who will give the recital from Blenheim Palace on Thursday. He will also conduct the City of Birmingham Choir and Orchestra in Part I of Bach's Mass in B minor at the Town Hall on Saturday. (7.30, Reg.)



installed in the Long Library at Blenheim Palace in 1891. Engraved over the console is the following inscription, written by the eighth Duke of Marlborough:

"In memory of happy days, and as a tribute to this glorious home, we leave thy voice to speak within these walls when ours are still." G. D. Cunningham, City of Birmingham organist, who has played several times at Blenheim, will give the recital.

NAPOLEONIC

ANTHONY ELLIS's second radio play on the subject of Napoleon comes into this week's programmes; the title is "His Father's Sword." The first play was "Brumaire," which was broadcast in 1935. The story is a brief account in dramatic form of Bonaparte's wooing of Josephine de Beauharnais, widow of the Vicomte Alexandre de Beauharnais, at one time Commander of the Revolutionary Army of the Rhine, but later executed as an aristocrat and a traitor against the Republic.

It is an imaginative reconstruction of the episode, and in writing it Anthony Ellis has availed himself of the dramatist's licence and selected those incidents which best accentuate the story, accepting as authentic material of doubtful historical exactitude.

As a very small boy Anthony Ellis listened to his Dutch grandmother's personal memories of the "Little Corporal." The old lady retained vivid memories of the days

when the French troops were billeted on her father's farm. The play will be broadcast on Tuesday at 7.30 (Reg.) and Thursday at 9.20 (Nat.).

OPERA

THOUGH first produced in 1890, Tchaikovsky's wonderfully vivid Russian tragic opera, "The Queen of Spades," otherwise known as "Pique Dame," only reached London in 1915. Pushkin's story describes a degenerate phase in the Russia of Catherine the Great. Acts I and II of this opera will be relayed from the Municipal Theatre, Berne, by Beromünster at 7 tonight (Friday). Statkowski's "Marya" comes from Warsaw at 7.5 on the same day. Statkowski won the first prize at the International Opera Competition held in London in 1903.

Sunday's performance of Stravinsky's "L'Histoire du Soldat" from Radio-Paris at 3 will interest those who love the ultra-modern. Strictly speaking, it is not an opera, but according to the standard works of reference, a "story told, acted and danced."

Tuesday brings something new from the 120-kW Rennes station. It is excerpts from Darius Milhaud's Opéra-Bouffe, "Esther de Carpentras." Milhaud is still a novelty to most of us, despite the recent B.B.C. performance of his "Christopher Columbus." At the present time he seems to be at the height of his powers, for almost every other week sees some new work of his produced on the French stage. The present broadcast will be preceded by Saint-Saëns' one-act "La Princesse Jaune," at 7.30. Produced in 1872, this was an utter failure, but has since won its way.

THE AUDITOR.

HIGHLIGHTS OF THE WEEK.

FRIDAY, APRIL 9th.

Nat., 7.30, Al Collins and his dance orchestra. 9.30, I Was There; Scott's last expedition.

Reg., 6 Recital, Laelia Finneberg (soprano) and Gordon Walker (flute). 8.45, B.B.C. Orchestra (E), conductor Glav Kielland.

Abroad. Beromünster, 7, Acts I and II of Tchaikovsky's "The Queen of Spades."

SATURDAY, April 10th.

Nat., 7.30, A.B.C.: An alphabetical miscellany. 8, Music Hall. 9.20, London is not England—Manchester programme.

Reg., 6, The Fol-de-Rols. 9, B.B.C. Theatre Orchestra.

Abroad. Stuttgart, 7.10, Variety: Part I—an evening with Robert Stolz Part II—popular music.

SUNDAY, APRIL 11th.

Nat., 7.15, Violin recital, Isolde Menges. 9.5, The First Days of Steam, a feature programme. B.B.C. Theatre Orchestra and Dmitri Smirnoff (tenor).

Reg., 4, Rawicz and Landauer; two pianos. 9.5, Sunday Orchestral Concert.

Abroad. Frankfurt, 7, "In Grandfather's Days"—visit to a dance of 1890 with a German and an American reporter.

MONDAY, APRIL 12th.

Nat., 6.40, From the London Theatre. The Music Shop—14. 7.45, The Adventures of Mr. Penny.—2.

Reg., 8, Songs You Might Never Have Heard—VII. 9, B.B.C. Theatre Orchestra and Alfredo Tomasini.

Abroad. Radio-Romania, 8, European Concert of Lithuanian music.

TUESDAY, APRIL 13th.

Nat., 8.10, Savoy Memories. 9.20, The Rt. Hon. Stanley Baldwin.

Tuesday, April 13th—(continued)

Reg., 6, Pianoforte recital; Franz Reizenstein. 7.30, "His Father's Sword." "The Lass of Richmond Hill; the true story behind the old song.

Abroad. Strasbourg, 7.30, Mozart concert by the orchestra of the Mozarteum Salzburg.

WEDNESDAY, APRIL 14th.

Nat., 7, Willy Lewis and his orchestra, from Paris. 7.45, and 9, The Symphony Orchestra at the Town Hall, Leeds

Reg., 8.30, B.B.C. Singers (B). 9.20, Callender's Senior Band.

Abroad. Radio-Paris, 7.5, Verdi's "Rigoletto" from the Grand Théâtre, Bordeaux.

THURSDAY APRIL 15th.

Nat., 7.40, Star Gazing; Edith Day. 9.20, "His Father's Sword." Recital: Antonio Brosa and Solomon.

Reg., 7.40, "The King's Pardon," short story. 8, Midland Organs and Organists. 9.30, Commentary on Farr-Baer fight.

Abroad. Radio Toulouse, 9.35, Excerpts from "Véronique" (Messenger).



BEBE DANIELS and her husband, Ben Lyon, before the H.M.V. recording microphone. They appear with Billy Bennett, Tessie O'Shea and Teddy Brown in this week's Music Hall. (Sat. 8, Nat.).

About Push-Pull

By "CATHODE RAY"

THE BASIC SYSTEM EXPLAINED

THIS is going to be very simple. Readers who, like me, are looking around for clear definitions of all the alphabetical barnacles that have grown around the original Push-Pull will not find them here. I think I know my "ABC," so long as it goes no further than that, but the other day I saw some reference to Class "D," and that leaves me one behind again.

No; for the benefit of any who would be unable at a moment's notice to give five reasons for preferring push-pull this is just going to be a simple account of the ordinary common variety, or, if one must be alphabetical, Class "A"; with perhaps an occasional reference to Class "B" thrown in.

First, briefly, what push-pull is. When it was invented, 22 years ago, valves were not very good. The characteristic curves were so short that they could effectively amplify only the positive half-waves of signal (Fig. 1 (a)). That is the same

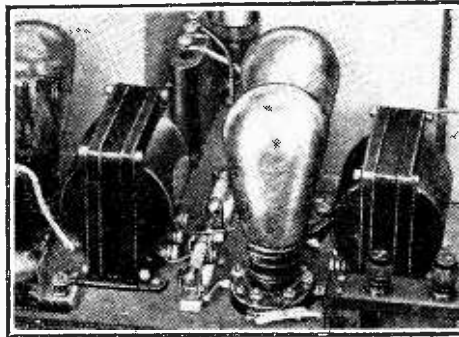

amplifier left out one half of the signal so long as it made a good loud noise with the other half. But at the date mentioned the idea of distortion and how to avoid it was beginning to occupy men's minds. If only the positive half-waves are amplified, distortion is very bad.

Now *negative* is simply positive reversed, so if another valve is connected "upside down" in the circuit then what is negative to the first valve, and therefore ignored by it, is positive to the second, and therefore amplified. So one valve deals with all the originally positive halves and the other with all the halves originally negative but reversed to look positive; and by putting the amplified products together again in the right order the result is a complete undistorted amplified wave.

Fig. 2 shows the basic circuit. At the date in question grid bias was not used, for valves then were near the "lower bend" even with no bias; with it, they would have been silenced altogether. Suppose, then, that only the upper valve is working. The output consists of positive halves only. Now if the lower valve is put in, at every moment when the upper valve receives a negative signal, and is therefore idle, the other (being connected to the input transformer the opposite way round) is getting a positive signal, which it is amplifying. The contributions from the two valves are put together again by the output transformer. It is like a couple of men who can push but not pull, sawing a log with a two-handed saw, sitting one each side and making themselves responsible for alternate strokes of the saw, instead of one man (or two men) sitting one side and having to do both pushing and pulling. ("Which, I suppose" you say "is why the former arrangement is called push-pull!" Well, as a matter of fact, it should strictly be called "push-push." But see on.)

As valves improved and became able to amplify both halves of a signal wave at once (Fig. 1 (b)), this system was abandoned; to be revived later for another reason, under the name of Class "B."

But although the development of power valves capable of handling the whole of a

signal without serious distortion seemed to make this type of circuit superfluous, actually it did not, as there were still several good reasons for continuing to use it. In fact, it is more popular at the present day than ever before.

Firstly, although a modern valve can amplify the whole wave, it never does it perfectly. At this stage we must distinguish between triodes and pentodes. Because the triode gradually becomes less effective as the grid voltage is made more negative, the negative halves are never

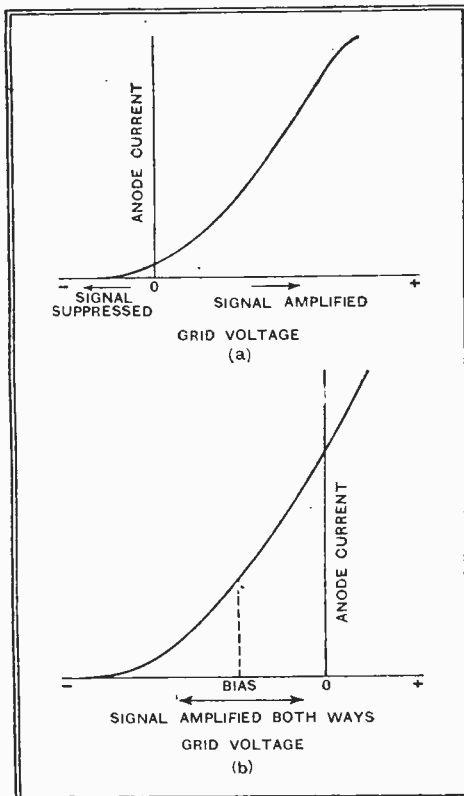

Fig. 1.—(a) Typical characteristic curve of very ancient valve (also of modern Class "B" valve). The negative half of the signal applied to the grid produces negligible effect, even if no negative bias is used. (b) Curve of typical power valve. When biased negatively there is still room for amplifying both halves of the wave, the positive slightly more than the negative, however.

thing as saying they worked as "anode bend" rectifiers. In the early days of radio nobody worried very much if an

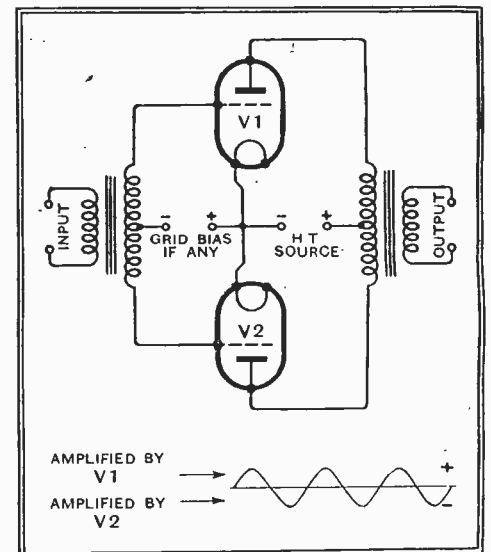

Fig. 2.—Basic push-pull circuit. One cannot definitely tell from the diagram what "Class" it is.

quite so full-grown as the positive (remember that what are called positive grid voltages are so relative to the negative grid bias; the grid, with the present system of working, is never driven actually more positive than the cathode). The lopsided wave thus produced is equivalent to an undistorted wave plus an added wave of double the frequency; in other words, a second harmonic. A triode valve causes second-harmonic distortion. The pentode, as usually adjusted, does not unbalance the wave in this way but it introduces a sort of S-shaped twist—a third harmonic.

From what has gone before, it should be clear that the lopsidedness due to triode amplification can be put right by using two valves as in Fig. 2. Both valves are now working all the time, like two men each alternately pushing and pulling a saw. But if each man is a little weaker in the pulling, it is an advantage to have this compensated by the strong push of his mate, which can be done if they take

About Push-Pull—

opposite positions. This, then, can legitimately be described as push-pull although the circuit is identical with push-push. The circuit itself is often loosely called the push-pull circuit, however used.

This balancing out of distortion means that two valves in push-pull give double the output of a single valve with less distortion, or more than double output with the same distortion. So far as triodes are concerned, this is a reason why push-pull is preferable to the same two valves in parallel, or one valve double the size. As the most serious part of pentode distortion is already equally balanced, this argument does not hold good for pentodes.

The reason just given is the usual answer to the question about the object of using push-pull. There are others.

Avoiding Magnetic Saturation

When a large output power is wanted, the design of the output transformer gets very difficult. If a single power valve is used, or several in parallel, there is a large steady current from the HT supply flowing through the primary winding from end to end. It magnetises the iron core so strongly that unless it is very massive indeed it is magnetically saturated—loses most of its virtue for the purpose. Then, when the valve is working to give a large output, this current alternately falls nearly to zero and rises to nearly double normal. Unless the iron core is very generously proportioned, the saturation effect tends to cut the above-normal peak as compared with the below-normal. In other words, harmonic distortion again.

But by connecting in push-pull (and assuming each valve draws its proper half share of current) then half of the current flows one way round the primary coil, and the other half the other way, completely neutralising the magnetisation. The core can therefore be made quite small even for a large feed current. Moreover, the magnetisation due to the signal starts from zero instead of from a strongly magnetised level, so there is less risk of the peaks being distorted.

The output transformer is one of the most expensive items in a good amplifier, and the saving on this alone due to push-pull may more than pay for the second valve! Another costly item, if the power is very large, is the smoothing choke, and for the same reason. Push-pull doesn't enable the heavy feed current—"polarising" current—to be split into opposing camps, but it does help in another way. A push-pull stage can tolerate very sketchy smoothing—it has even been worked with no smoothing choke at all—because any ripple that is left over from the smoothing condenser sends currents through the valves in such a way that they cancel out so far as any effect on the output transformer secondary is concerned. Hum from other causes—grid bias or heaters—also tends to balance out. It is true that the earlier stages in the amplifier still need adequately smoothed HT, but as the current to be dealt with is relatively small a

cheap resistor or tiny choke may do all that is required.

Even in this part of the circuit push-pull is helpful. If it is not used, the working of the output stage causes large signal currents to circulate through the HT supply, and, owing to the considerable smoothing impedance required there, these currents cause corresponding fluctuations of voltage that are passed on via the HT feed to the earlier stages. Thorough decoupling is then needed to prevent trouble. But with push-pull the signal current in the HT supply is practically nil, and these precautions may be greatly relaxed.

There are other advantages for special purposes. Line telephone amplifiers use push-pull so that the system is balanced with respect to earth, and, therefore, less liable to cause "cross-talk" (interaction between lines, which may ultimately result in other sorts of cross talk).

Television receivers use it for the deflector voltages applied to the scanning plates of the cathode-ray tube. Although the power involved is quite small, single valves are undesirable because they would cause the average voltage at that part of the tube to vary, which would have the effect of defocusing the spot of light. Push-pull makes one plate negative while the one opposite is positive, so keeping the average steady.

Ultra-high-frequency oscillators are often connected in push-pull, because a balanced system is more likely to work well when unbalanced stray capacities have such vital influence as in ultra-short-wave work.

I mentioned that the original purpose of a balanced circuit, used as push-push or Class "B," has long since disappeared; and what I have been describing is true push-pull or Class "A." The reasons for the revival of Class "B" are too complex to dismiss in a sentence, so perhaps they will do for the next time.

The Radio Industry

PHILCO receivers will in future be distributed throughout London and the Home Counties by Philco Southern Distributors, Ltd.; this firm is transferring its headquarters from Redhill to London.

The five Lockheed Electra aircraft recently purchased by British Airways have been equipped by Standard Telephones and Cables with Lorenz Blind Approach Receiving equipment. The complementary Lorenz ground apparatus has been installed at Gatwick and Croydon airports.

Radiometers, Ltd., of Eagle House, Jernyn Street, London, S.W.1, informs us that a new Data Book for use with the Universal Valve Tester will shortly be available. The book, which will be in loose-leaf form, is to cost 2s. 6d., and the contents will be arranged for speedy reference.

A central receiver feeding ten separate loud speakers has been installed at the Savoy Hotel by Ismay Distributors. The basic unit is a Halcyon Model A581 chassis, which feeds a 20-watt amplifier.

R.C.A. Photophone, Ltd., have recently installed high-fidelity sound reproducing equipment at Radio Luxembourg.



MCCARTHY

Important! The prices at which McCarthy Chassis are advertised include Marconi Royalties. "Wireless World" readers should, for their own protection, make sure before purchasing any receiver that the quoted price includes the Royalty payment.

MCCARTHY ALL-WAVE SIX

with radio frequency stage

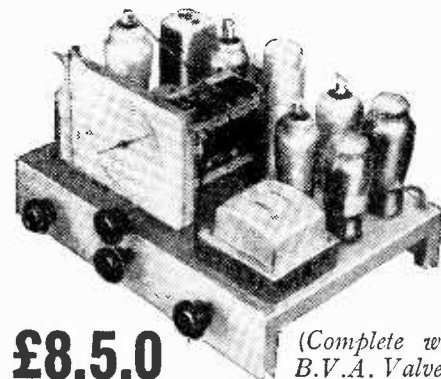

£8.5.0 (Complete with B.V.A. Valves.)

"De luxe" 6 valve receiver with 8 valve performance (specially recommended for tropical and foreign reception conditions). Built on special cadmium-plated 18 gauge steel chassis. Variety iron-cored I.F. coils. Litz-wound tuning coils. 3 wave-ranges—16.5-2,000 metres. Illuminated "Airplane" dial with principal station names. Micro-vernier 2-speed drive. Circuit comprises: Pre-selector radio frequency amplifier (operative on all wavebands), triode-hexode frequency changer, double band-pass coupled I.F. amplifier, double diode detector, D.A.V.C. applied to 3 preceding valves. L.F. amplifier and pentode output. Variable tone control and volume control operate on radio and gramophone.

BATTERY ALL-WAVE SIX

£7

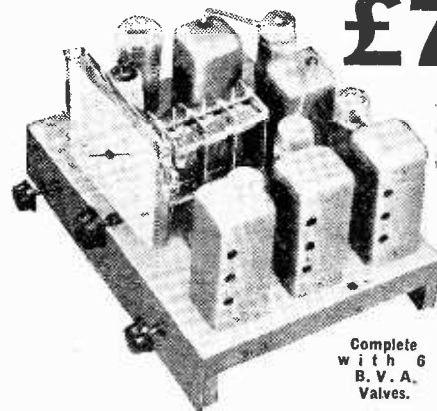

Complete with 6 B.V.A. Valves.

The only receiver of its type now on the British market. Results on all 3 wavebands equal to mains operation. Latest technical developments incorporated in circuit. Latest types valves, transformers, tuning coils, switches, etc. Specification in brief: radio frequency amplifier, first detector with separate triode oscillator, I.F. amplifier, double diode detector, L.F. amplifier, low consumption pentode output. D.A.V.C. volume control and tone control both operative on gramophone. Illuminated dial with station names. Wave-ranges: 16-52, 200-550, 900-2,000 metres.

All McCarthy receivers supplied complete with valves, knobs, pilot lamps, leads, mains cable and plug. 12 months' guarantee.

Deferred terms on application, or through London Radio Supply Co., 11, Oat Lane, E.C.2.

Cash with order on 7 days' approval. Also write for illustrated catalogue of complete range of all McCarthy receivers.

MCCARTHY RADIO LTD.
44a, Westbourne Grove, London, W.2

Telephone: Bayswater 3201/2.

The Television Receiver

VI.—THE OUTPUT STAGE

By W. T. COCKING

IN dealing with the output stage of a sound receiver we are accustomed to think in terms of power, for the loud speaker which it feeds is a power-operated device. The cathode-ray tube adopted for television, however, is voltage-operated, and requires power no more than an ordinary valve which is functioning with adequate negative grid bias. Since the tube needs an input of something like 30 volts p-p only, it would at first appear that the output stage of a television receiver would not offer any particular difficulties.

The input voltage required by the tube must be developed across a coupling impedance, however, and we have seen in the earlier articles in this series that because of the enormous range of frequencies involved this impedance must be of low value. It follows that an appreciable amount of power is required in order to develop the necessary voltage across a low impedance. Although the tube itself does not require a power input, as does a loud speaker, the voltage for operating it cannot be produced without the expenditure of power in the coupling.

If we feed the CR tube directly from the detector in the manner described in Part V, then for a tube input of 30 volts p-p the detector input must be about 15 volts RMS for a voltage-doubler detector, 30 volts RMS for a single diode, and 60 volts RMS for a push-pull detector. This input voltage must be developed across the intervalve coupling by the last RF or IF valve, and quite a large amount of power is involved.

For a moderate degree of sideband cutting with a single tuned circuit the coupling impedance at resonance should be no more than 1,000 ohms when a band-width of 4 Mc/s is required. Since power is equal to E^2/R , we find that the power output should be 0.225, 0.9, and 3.6 watts for the three detectors enumerated above. Actually, of course, a single tuned circuit is an unsuitable coupling for either the voltage-doubler or the push-pull detectors since each requires a transformer which is really the equivalent of a band-pass filter. This type of coupling is also more suitable for the single diode, since it permits the attainment of a higher load impedance on the valve for a given frequency response.

The power required, however, does not seem excessive in view of the amounts to which we are accustomed in sound reproduction, but when we examine the case in detail it will be seen to be quite difficult to obtain it. An output-type pentode will give an output of some 2.5-3.5 watts with moderate distortion, but only when it has a load impedance of some 5,000-10,000

ohms, according to the exact valve used. In television IF circuits, however, we cannot employ a load of more than about 2,500 ohms at most, and even that only under the most favourable circumstances.

THE considerations affecting the design of the output stage of a television receiver are discussed in this article. Particular attention is paid to the case when this valve is also the last IF amplifier

Suppose we find a valve which will give 3 watts into a load of 5,000 ohms, what voltage are we likely to get in a load of 2,500 ohms? When a pentode is used with a low-impedance load the output voltage across the load is roughly proportional to the load impedance. Three watts in a 5,000-ohm load means a voltage of 122.5 volts across it, so that if we use a 2,500-ohm load we cannot expect to obtain more than 60 volts across it. It is only in the most favourable circumstances that we can use such a high load, however, and if we can employ only 1,000 ohms we can develop only about 25 volts across it.

An exact solution can be obtained by the usual graphical process from the valve curves, but it must never be forgotten that it is not always easy to apply the full voltage to the detector. There is always some loss of voltage in the diode load resistance by-pass condenser, and this is appreciable with low intermediate frequencies. Accurate calculation is consequently difficult, and computation should not be relied on, but should be checked by measurement.

Various arrangements have been tried by the writer, and among them the following give a useful guide to the results obtainable. In every case the last IF valve was an N43 pentode.

(1) Single diode detector in receiver for single-sideband operation at an IF of 4.5 Mc/s. Series-resistance type coupling to detector. Max. undistorted output = 20 v. p-p.

(2) Voltage-doubler detector in single-sideband receiver at 3.5 Mc/s. Transformer coupling to detector. Max. undistorted output = 30 v. p-p.

(3) Single diode detector in receiver for double-sideband operation at 10.0 Mc/s. Transformer coupling to detector. Max. undistorted output = 30 v. p-p.

(4) Voltage-doubler in receiver for double-sideband operation at 8.0 Mc/s. Transformer coupling to detector. Max. undistorted output = 60 v. p-p.

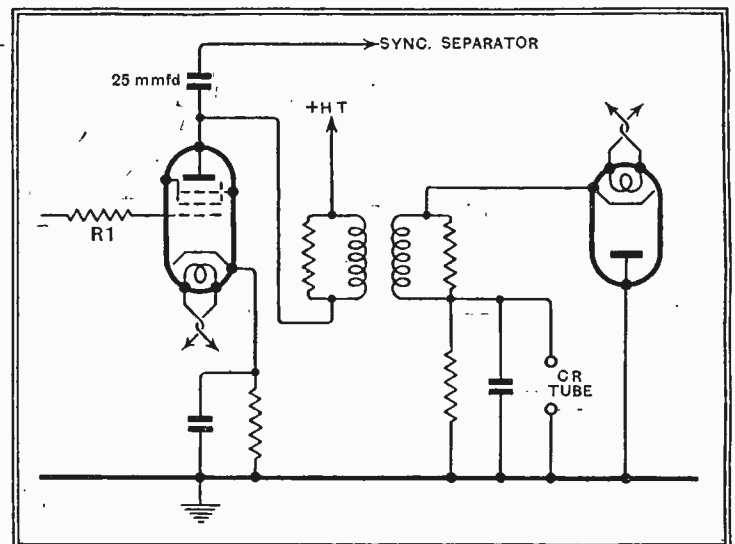

Fig. 16.—At high intermediate frequencies sufficient output can be obtained with a single diode detector and an N43-type pentode for the last IF valve.

With the N43 valve it is possible to secure a 30-volt p-p detector output from a single diode provided that transformer coupling is adopted and that the intermediate frequency is not lower than 8.0 Mc/s. If the frequency must be lower than this, then it will be necessary in most circumstances to use a voltage-doubler detector.

The N43 can be successfully employed as an IF valve provided that the frequency is not too high; the writer has used it successfully at 10.0 Mc/s in the circuit of Fig. 16. The grid-stopper R1 of 50 ohms is necessary to prevent parasitic oscillation. The coupling transformer is tuned by the stray capacities, and each winding must be experimentally adjusted for resonance at the intermediate frequency. The coupling must be tightened sufficiently to enable the required band-width to be obtained, and the resistances then chosen to smooth out the peaks in the response. As

The Television Receiver—

a guide to those interested, it may be said that for 10.0 Mc/s the writer has used coils wound end to end on a 0.75in. diameter former, the gap between primary and secondary being about 1/32nd inch. The secondary needed 38 turns of No. 32 DSC and the primary 20 turns only, the difference being occasioned by the difference in

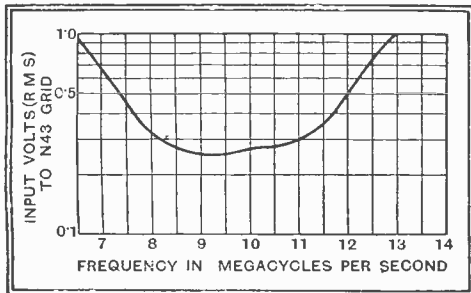

Fig. 17.—The frequency-response curve of the transformer coupling used in the last stage.

the stray capacities. Incidentally, the primary capacity is rather heavy on account of the N43 and also because of the sync separator.¹ With a primary shunt resistance of 3,500 ohms and a secondary shunt of 10,000 ohms, the resonance curve of Fig. 17 was obtained. The curve was taken with an unmodulated input to the N43 grid and for a constant rectified voltage across the diode load resistance of 3 volts. At 10.0 Mc/s the N43 input was 0.27 volt RMS, so that the ratio of detector output/N43 input is $3/0.27=11.1$; this figure is also the effective ratio between the detector peak-to-peak output and the N43 RMS input on 100 per cent. modulation, so that it represents the effective gain of the last IF valve taking into account the AC/DC

¹ The Wireless World, January 22nd, 1937.

conversion efficiency of the detector. For a 30 v. p-p output, therefore, the N43 must have an input of 2.7 v. RMS.

The N43 has a very low grid-anode capacity—for an output-type pentode. Actually, it is about 0.3 $\mu\mu\text{F}$, and is very high for operation at radio frequency. Owing to the low efficiency of the circuits, however, it is quite possible to use it at 10.0 Mc/s (30 metres), but even so there is considerable feed-back through the capacity, and it is not easy to design the coupling of the penultimate stage by calculation. In the writer's opinion, the valve would probably become unusable at much higher frequencies unless neutralisation of the grid-anode capacity were adopted. It would almost certainly be impossible to use it in a straight set at 45.0 Mc/s.

Because of this, one is usually forced to adopt VF amplification if a high operating frequency is used. Actually, a vision frequency output stage is in any case more economical so far as the output stage itself is concerned. In the first place, the bandwidth is halved, with the result that the load impedance is doubled and the power output halved; and, secondly, the detector losses come before instead of after the power stage, so that the power output is still further reduced. Instead of a power output of 0.2-3.0 watts being needed, it can be as small as 0.032 watt (30 v. p-p across 3,500 ohms), and it is just possible to obtain this from an RF pentode.

The use of VF amplification has certain disadvantages, as pointed out in Part II, but its superiority in the matter of power output may lead us to reconsider the advisability of including it. Should we for any reason decide to adopt a high intermediate frequency we shall be practically forced to use it.



They SHOULDN'T DO IT— BUT **THEY DO!**



WE'VE all heard those "famous last words"—all except the fellow most intimately concerned. He has to pay for his fame. Unfortunately, in your business your customer has the last word . . . and YOU PAY! He's not worried when he switches on with the wrong transformer tapping used—he's got your guarantee, and he will still be there to claim. Have the last word yourself—you can if you fit T.C.C. Wet Electrolytics. However careless your customer, high voltage surges just cannot pass—and are kept within safe limits—so are your SERVICE COSTS.

FOUR TYPICAL TYPES

Type	Capacity	Continuous Working Volts
802	16 mfd.	440 volts Peak
802	8 mfd.	440 volts Peak
805	8 mfd.	500 volts Peak
809	32 mfd.	320 volts Peak

Special types are available to meet the stringent conditions found in A.C./D.C. Receivers. Write for full details.

T.C.C.
VOLTAGE REGULATING
WET ELECTROLYTICS

THE TELEGRAPH CONDENSER CO., LTD.,
WALES FARM ROAD, NORTH ACTON, W.3.

1477

Television Programmes

Transmission times are from 3-4 and 9-10 daily.

Vision 45 Mc/s. Sound 41.5 Mc/s.

FRIDAY, APRIL 9th.

3, Chief Os-Ke-Non-Ton in North American Red Indian songs. 3.10, Friends from the Zoo. 3.25, Gaumont-British News. 3.35, Scenes from a new cabaret now running in the West End. 9, Beatrix Lehmann and Ernest Milton in scenes from Shakespeare's "Richard III." 9.10, Repetition of 3.10 programme. 9.25, British Movietonews. 9.35, Repetition of 3.35 programme.

SATURDAY, APRIL 10th.

3, Living History—the use of models in teaching history. 3.20, John Carr's Jacquard Puppets. 3.35, British Movietonews. 3.45, "Thomas and Sally or The Sailor's Return"—dramatic pastoral composed by Dr. Arne. 9, Repetition of 3.20 programme. 9.15, "Queue for Song," a little show. 9.35, Gaumont-British News. 9.45, Repetition of 3.45 programme.

MONDAY, APRIL 12th.

3, Fashions for cruising—parade of clothes for sea travel. 3.15, British Movietonews. 3.25, Cabaret Cruise.

9, Repetition of 3 programme. 9.15, Gaumont-British News. 9.25, Repetition of 3.25 programme.

TUESDAY, APRIL 13th.

3, Vienna Boys' Choir. 3.5, The World of Women. 3.20, Gaumont-British News. 3.30, Henry Hall and the B.B.C. Dance Orchestra. 9, Repetition of 3 and 3.5 programmes. 9.20, British Movietonews. 9.30, Dorset Garden; a miniature restoration revue.

WEDNESDAY, APRIL 14th.

3, Snooker; exhibition of play by Horace Lindrum and Willie Smith. 3.10, Preview of Daffodil Show. 3.20, British Movietonews. 3.30, Forty-fifth Picture Page. 9, Music Makers, Alfredo Tomasini. 9.10, Repetition of 3.10 programme. 9.20, Gaumont-British News. 9.30, Forty-sixth Picture Page.

THURSDAY, APRIL 15th.

3, Comedy Act. 3.5, Masks through the Ages—11. 3.20, Gaumont-British News. 3.30, "Ad Lib.": a revue by Herbert Farjeon. 9, Henry Hall and the B.B.C. Dance Orchestra. 9.30, British Movietonews. 9.40, Repetition of 3.5 programme. 9.55, Comedy Act.

Current Topics

Norwegian Concession to Tourists

FOREIGN tourists who take wireless receivers with them to Norway are to be exempt from the necessity of obtaining a Norwegian listener's licence provided that their stay does not exceed eight weeks. This ruling applies to any type of wireless set irrespective of whether it be carried in a car, a yacht, or in any other manner.

Mountaineers' S O S.

THE possession of a trans-receiver has been the means of saving the lives of certain members of a scientific expedition engaged in exploratory work in the Andes. Some members of the party became separated from the main body during a blinding snowstorm at an altitude of over 6,000 ft. A call for help was picked up at the base and a relief party immediately set out. The lost explorers were eventually located and rescued.

Well-known Wireless Personality Dead

BY the death of Brigadier-General Sir Capel Holden on March 30th, at the age of 81, wireless loses one of its oldest enthusiasts. Sir Capel Holden, who was Director of Mechanical Transport during the War, always took a great interest in wireless matters, and in 1927 became President of the Radio Society of Great Britain.

Pirate Transmitter Baffles German Police

APPARENTLY the German authorities are not so good at tracking down illegal wireless transmitters as is the British G.P.O. For some time past the resources of the German radio detectives have been directed to the unearthing of a transmitter accused of broadcasting subversive propaganda. The Government direction-finders appear to differ as to the location of the station, not only from day to day but almost from hour to hour. It would appear, therefore, that either the station is a mobile one or that there are a number of them, each working according to a pre-arranged time-table.

The International Musical Festival

SEVERAL sessions of the annual Music Festival organised by the International Society of Modern Music, which will be held in Paris this year, are to be broadcast by all French stations. The festival will be held from June 20th to the 27th during the International Exhibition.

EVENTS OF THE WEEK IN BRIEF REVIEW

Coronation Ceremonies and Recording

ALTHOUGH anybody is at liberty to relay to the public any ceremony or musical programme broadcast by the B.B.C. in connection with the Coronation, they must not record them except by permission of the Earl Marshal. The Performing Right Society has waived all fees for the relaying of copyright music broadcast during the festivities.

French Licence Figures

IN France crystal-set owners do not pay so much for their licences as valve-set users. For crystal sets 15 francs per annum is demanded. There are 67,369 of these licences in use. Valve-set users make up by far the greater part of French listeners, there being no fewer than 3,642,944 of these out of a total of 3,759,690. These pay 50 francs each. Receivers used for free public listening contribute the sum of 100 francs per licence,

A Trip to Paris

REMARKABLE enterprise is being shown by the Southall Radio Society, who are arranging a special trip to the French Radio Show. The party is not restricted to members of the Society, and other wireless enthusiasts will be gladly welcomed. The cost will be about £2 per head, and no passports will be required. It is proposed that the party should leave on Friday evening (May 21st) and return on the following Sunday. Those interested should get into touch immediately with Mr. S. Gould, 3A, Argyle Road, West Ealing, London, W.13, who will be glad to furnish full particulars of the exhibition and travelling arrangements.

Paris Exhibition News

IT has been decided that the S.P.I.R. (Syndicat Professionnel des Industries Radio-Electriques) and the C.S.I.R. (Chambre Syndicale de L'Indus-

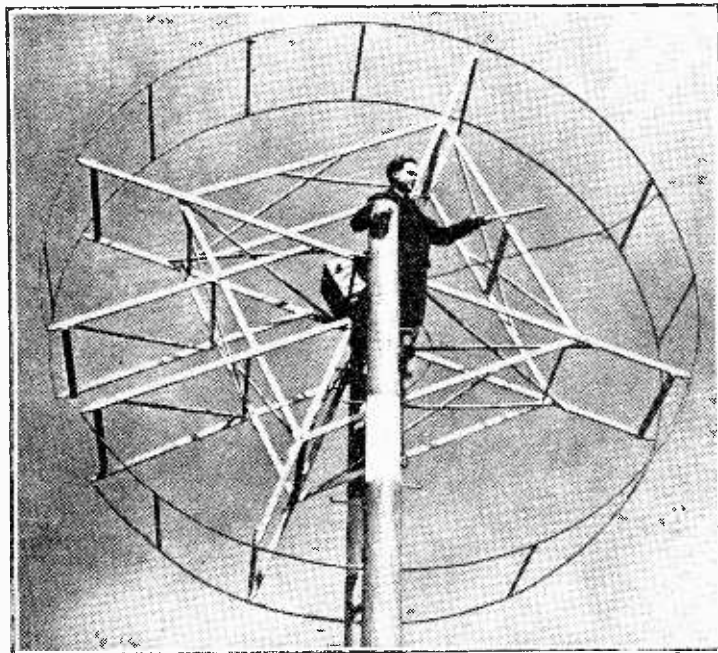

DIRECTIONAL LOOP. This 20ft. aerial, installed at the Grand Central Air Terminal, Glendale, California, is part of a new long-range transmitting station serving the whole of the American trans-continental aircraft route.

while, if a charge is made for listening, 200 francs is payable.

Station Migrating

A WIRELESS station with a mast nearly 500ft. high is being built at Argenteuil by the French N.B.C. (Compagnie Nationale de Radiodiffusion). This will be the new transmitter for the Radio-Cité station. The studios will remain in Paris.

trie Radio-Electrique) will have a collective stand in the International Exhibition in the Grand-Palais des Champs-Élysées. The S.P.I.R. is to have its own Spring show from May 14th to the 30th in the Palais du Neó-Parnasse in the Boulevard Raspail, while the C.S.I.R. will exhibit in the Foire de Paris during May. There will be no official Salon in September this year.

Manchester Anticipates Trouble

IT has been announced that before very long trolley buses will replace trams in Manchester. This has caused a certain amount of uneasiness among listeners, who have heard reports of very severe interference in other districts in which trolley buses have made their appearance.

The Manchester City Transport manager has, however, intimated that all buses will be fitted with suitable suppressors in order to prevent any trouble of this nature.

Sound Effects on Sale

A NEW company is said to have been formed in America to record every possible type of sound effect likely to be required by the producers of broadcast plays. Over forty records containing 120 different sound effects have already been made, and these will be offered to the various broadcasting authorities throughout the world.

Mecca Calling

CONSIDERABLE difficulties were encountered in the building of the broadcasting station which has just been completed in the Holy City of Islam. Since the station stands on holy ground, to which unbelievers are not admitted, only Moslem engineers could be permitted to erect the station. Four natives were therefore sent to London to study radio engineering. All the material for the station had to be taken to Mecca on camels owing to the absence of railway facilities. The station will be used chiefly for broadcasting the prayers and ordinances of the Prophet and disseminating his teaching. It will also be employed for the spreading of Arabian culture generally.

U.I.R. Meeting

AT the Berlin meeting of the International Broadcasting Union four new members were admitted, namely, the Broadcasting Services of Bulgaria, Canada and India, and the U.S.A. National Association of Broadcasters. The questions discussed included wavelengths, acoustic problems and television. In addition, the schedule of International European concerts for the season 1937-1938 was fixed.

Association for French Broadcasting Employees

THE personnel belonging to the artistic, literary and news sections of the State Broadcasting Service have formed themselves into an association and have applied for affiliation to the French T.U.C. (Confédération Générale du Travail).

The Manufacturer's Guarantee

WHAT IT MEANS

By "ALTER EGO"

BIOLOGISTS say that the uni-cell lives for ever. This simple form of life has little in it to go wrong.

At the other end of the scale is man, a highly complex organised organism, the failure of *any one* of whose parts might stop his working. At his birth he is plunged into the world without a guarantee, but his stay here below in working order and condition does not bear comparison with a uni-cell.

A wireless receiver, radiogramophone, or television set is a complex man-made article for which the purchaser pays good, hard cash, and for that reason alone, it seems, should be better than anything that Nature produces.

For about ten guineas upwards a wireless receiver can be purchased all complete and ready for working, definitely with knobs on, and sometimes handles. But the manufacturer, unlike Nature, knowing that it is a complex article, actually gives a guarantee with the instrument. To some this guarantee represents the assurance of the manufacturer that nothing will go wrong with his receiver within a certain time, and that inference is the first mistake so widely made by members of the general public, and is the root cause of so much dissatisfaction to-day.

The word "guarantee" has been so abused and twisted about that it has been misinterpreted when applied to wireless apparatus. It means "to be responsible for." The wireless manufacturer gives documentary assurance that if anything goes wrong with the instrument within a stated time he will put it right for nothing, provided that it is brought to him. He does not guarantee that the set *will* not break down. Nobody can do that.

In every instrument there are valves, resistances, condensers, loud speakers, transformers, switches and other things which may or may not be made by reputable sub-contractors or specialists, and in spite of all precautions any one of these may break down, causing defective working or a complete stoppage. These proprietary units are tested by the men who made them, and when they are delivered to the instrument manufacturer they are tested and examined, as a rule, before passing to his stores. On withdrawal from the stores they are usually tested before going out to a manufacturing line, and when the chassis of the instrument is being tuned up—i.e., lined or tracked against standard signal generators—the components are functioning under working conditions. After being encased in a cabinet or other housing the general procedure is to give the instruments a reception test and lastly a life test.

In spite of all these precautions, no

manufacturer can see the *insides* of all the component parts he uses. He cannot tell you, for example, that the insulation of the windings of a mains transformer is perfect. There *might* be a flaw somewhere in the goods he is using which have so rigorously been tested by the men who made them and by his own staff.

In short, there is no method known to science or industry by which it is possible to forecast the life of any component tested and used in a wireless receiver short of invoking the aid of psychic mediums, and then I cannot see how they could help. Surely a medium can only see what is going to *happen*, and how could it happen if the component destined to cause the breakdown is changed before the issue of the wireless receiver.

Having regard to these indisputable facts a manufacturer would be a fool to take on such a profound responsibility as to state categorically: "This receiver *will* not break down for three months."

The manufacturer's guarantee on a complex article like a wireless instrument, therefore, is not an assurance that it *will* not go wrong, but that if it *does* go wrong he will put it right free of charge during the stated period.

Once the correct interpretation of the word "guarantee" is gripped, it does a great deal to smooth the way to understand the rest.

The Electrical Encyclopedia. Edited by S. G. B. Stubbs. Waverley Book Co., Ltd., London. Price 70s. (four volumes).

THE second edition of an exceedingly comprehensive work first published two years ago. The material is arranged in alphabetical order and articles by authorities cover every branch of electrical engineering. The new edition brings the articles up to date where necessary, and new matter has been added. In addition to the four volumes there is supplied with them a pocket-book of electrical tables and useful data contained in 64 pages.

The "Express" Division Reckoner. Pp. 120. Published by Gall and Inglis, 12, Newington Road, Edinburgh, 9. Price 2s. 6d.

THIS book is the converse of the ordinary ready-reckoner inasmuch that it divides instead of multiplying, the cost of a unit being quickly ascertainable from the total cost. It is particularly useful in working out the value of each instalment when a wireless receiver is being bought or sold by the hire-purchase system.

Fame. Edited by Terry Ramsey. Pp. 278; numerous illustrations. Published by Quigley Publications, New York.

A BOOK devoted, among other things, to statistics concerning the popularity of artistes in the various branches of the entertainment world. The data concerning broadcasting artistes—confined to those appearing at American stations—is compiled from the votes of more than 400 radio editors in the U.S.A. and Canada.

POINTS OF IMPORTANCE in the Rola G.12

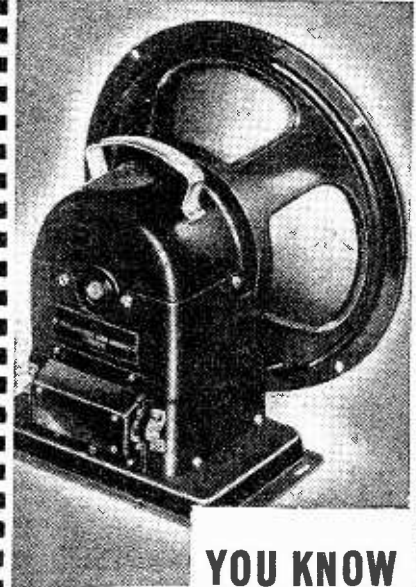

YOU KNOW A GOOD WINE BY ITS VINTAGE . . .

. . . and a good speaker by its reputation. For just as the connoisseur can judge the wine he is buying by a glance at the label so the experienced radio enthusiast can judge a receiver by the speaker with which it is equipped. All lovers of good radio entertainment know that their surest guarantee of a high quality receiver is to buy a set with a G.12 speaker. For such a unit would be wasted in an indifferent set. This famous Rola unit is used by the leading manufacturers in their best receivers and it is significant that it is just these models that have shown the greatest sales increase during the past year. For brilliance of tone, genuine high fidelity reproduction and the utmost reliability you cannot equal a Rola G.12.

G.12 D.C. (as illustrated) complete with Transformer, Mounting Stand, Handle and Base...	£5 5 0
G.12 D.C. with Mounting Stand, Handle and Base, but without Transformer	£4 16 0
G.12 D.C. Stripped, but with Transformer	£4 4 0
G.12 D.C. Stripped and without Transformer	£3 15 0
(When ordering please state Field Resistance and Impedance of Transformer required.)	
G.12 P.M. less Transformer	£4 16 0
G.12 P.M. with Transformer	£5 5 0

For Public Address work both the P.M. and Energised Models can be supplied with a 15 ohm Voice Coil at an additional charge of 3/-.
Write for Folder A.

OVER 8 MILLION IN USE

ROLA

The World's Finest Reproducers

THE BRITISH ROLA CO., LTD.
MINERVA ROAD, PARK ROYAL, N.W. 10.
PHONE: WILLESDEN 4322-3-4-5-6.

Brief descriptions of the more interesting radio devices and improvements issued as patents will be included in this section.

Recent Inventions

LONG- AND SHORT-WAVE AERIALS

AN aerial is arranged so that it can be used either for short-wave working or for receiving ordinary medium- or long-wave programmes. The down-lead consists of three strips of copper, which are separated by insulators inserted at intervals along their length and are closely wound inside a common flexible cover. The strips are connected either (a) to a dipole aerial or (b) to a second wire arranged at right-angles to the dipole and acting as an earthed T or L aerial, the two alternative modes of connection being controlled by a switch. The whole arrangement is such that the impedance of the down-lead is low, and no coupling-transformer is necessary at the aerial end.

Marconi's Wireless Telegraph Co., Ltd., and N. M. Rust. Application date June 8th, 1935. No. 458084.

PREVENTING VALVE DISTORTION

ONE effect of valve-curvature is the production of undesired harmonics, whilst another is the inter-modulation of any currents of different frequency that may be present.

The Figure shows a circuit in which non-linear distortion is prevented by a method of feeding back components from the output to the input in a compensating sense. A potentiometer R, R₁,

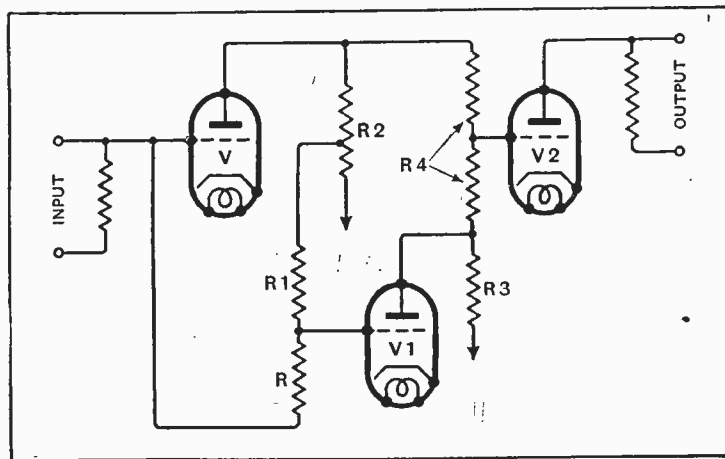

Method of obtaining distortionless amplification.

R₂ is provided between the output from the amplifier V and its grid, and a tapping is taken from a point between R and R₁ (which remains at a practically constant potential when no distortion is present) to the grid of an auxiliary valve V₁. The result is that if any distortion components are present in the resistance R₂ they are compensated, so far as their effect on the subse-

quent amplifier V₂ is concerned, by corresponding fluctuations produced in the output resistance R₃ of the valve V₁. The amplification factor of the valve V₁ is twice that of the valve V, and the two anode circuits are connected together through a high resistance R₄ having a mid-point tapping to the grid of the valve V₂.

Marconi's Wireless Telegraph Co., Ltd., and G. M. Wright. Application date June 21st, 1935. No. 458449.

REACTION CIRCUITS

THE grid and anode of an amplifier or detector valve V (which may be a pentode), are back-coupled through the coil L,

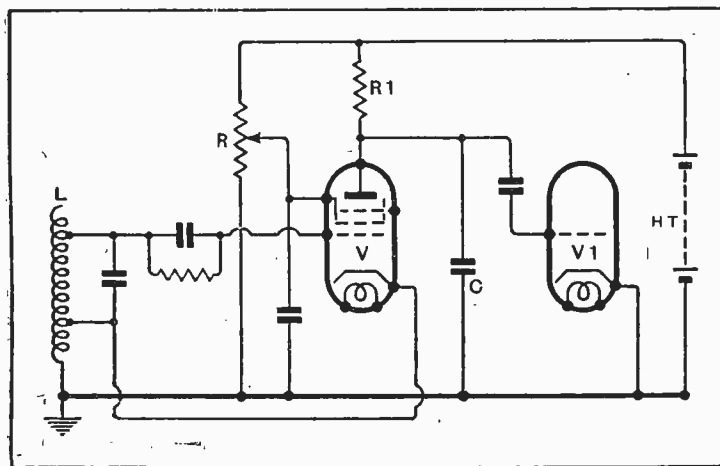

Detector circuit giving smooth control of regeneration.

the upper part of which is in the grid-cathode circuit, whilst the lower part is on the anode-cathode circuit. The screening grid is adjustably biased from a tapping on

ance R, is stated to be particularly smooth and convenient.

Baird Television, Ltd. and L. R. Merdler. Application date June 18th, 1935. No. 458133.

TELEVISION RECEIVERS

TO protect the bulb of a cathode-ray receiver, it is mounted immediately behind a concave "window" of unbreakable glass, or a grill of open-mesh thin wire. The use of a concave surface is found to minimise the effect of any light reflected back from external objects. This is an advantage, since the light intensity of the received picture is generally small.

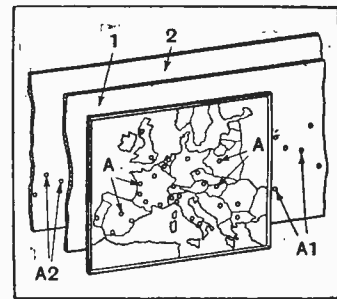

Details of tuning dial with stations arranged geographically on a map.

such that when the set is tuned, say, to the programme from Rome, a hole A₁ in the panel 1 coincides with a hole A₂ in the panel 2, and both come into alignment with the particular hole A which represents the position of Rome on the map. When this occurs, the light from a lamp located behind both of the panels appears through the holes, to indicate the position of the station received.

Fabrica Italiana Magneti Marelli. Convention date (Italy) February 6th, 1935. No. 458059.

SCANNING SYSTEMS

WHEN magnetic deflecting-coils are used to control the scanning movements of the electron beam inside a cathode-ray tube, their inductance tends to slow-up the "flyback" movement of the beam. In order to prevent this, both coils are shunted by a gas-filled valve.

Since the "flyback" stroke is more rapid than the working stroke, the voltage induced across the coils acquires a value sufficiently high to discharge the gas-filled valve. The coils are therefore short-circuited during each of the "flyback" periods.

Marconi's Wireless Telegraph Co., Ltd., and G. B. Banks. Application date June 8th, 1935. No. 457929.

AMPLIFYING CIRCUITS

IT is found that when a valve amplifier or photo-electric cell works on to a load which has a negative-resistance characteristic, the resulting "load-line" shows a more favourable performance. In the case of a photo-electric cell, for instance, a greater change of cell-current is produced for a given change in illumination.

Accordingly an "electron-multiplier" of the type having two electron-emitting surfaces, between which the stream passes and re-passes to produce secondary emission, is used as the load impedance of an amplifier valve or P-E cell, and, because of its negative resistance characteristic, gives a performance higher than is usually obtained. In addition it is stated to reduce the well-known Miller effect.

Baird Television Ltd. and J. C. Wilson. Application date April, 1936. No. 457886.

The "window" may be hinged to the cabinet, and, when opened, automatically cuts off the high-tension supply so that the circuits are made "dead." The same safety device is automatically brought into operation if the window is accidentally broken.

Marconi's Wireless Telegraph Co., Ltd., and A. A. Linsell. Application date May 24th, 1935. No. 457274.

STATION INDICATORS

THE object is to indicate, on a map associated with the tuning dial, the geographical situation of the station to which the set is, for the time being, tuned. As shown, a map of Europe is mounted in a window on the cabinet and is provided with a series of small holes, A, to show the location of transmitters in various countries.

Behind the map are two sliding panels 1, 2, both of which are controlled by the tuning-knob in such a way that whilst one panel moves to the right, the other moves to the left. Each panel is pierced with holes marked A₁, A₂, respectively. The arrangement is

The British abstracts published here are prepared with the permission of the Controller of H.M. Stationery Office, from Specifications obtainable at the Patent Office, 25, Southampton Buildings, London, W.C.2, price 1/- each. A selection of patents issued in U.S.A. is also included.

NEW PROJECTOR TYPE Public Address LOUDSPEAKER

Incorporating a new design of MONO-PLANAR directional baffle with special divided flare, this new Loudspeaker provides the effect previously only obtainable with two speakers.

Sound distribution is vastly improved—particularly of the high notes. Moreover, the special diaphragm fitted gives extremely good high note response.

Especially noteworthy is the fact that the highly efficient Permanent Magnet Unit is totally enclosed in a non-resonant chamber thereby considerably increasing the loading on the diaphragm at low frequencies, and obviating risk of damage to the diaphragm in the event of overload.

GOODMANS

for Quality Reproduction

GOODMANS INDUSTRIES LTD., Lancelot Rd., Wembley, Middx.

Telephones: Wembley 4001-3.

Goodmans Duplex Horn
P.A. Loudspeaker

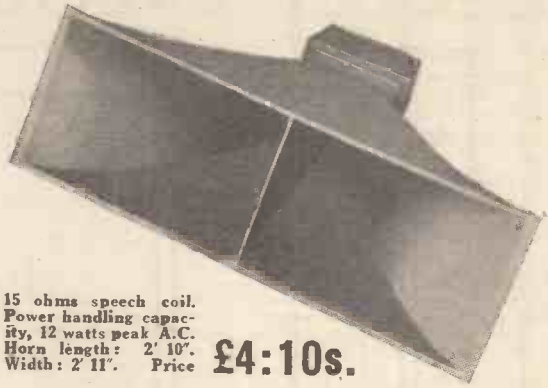

15 ohms speech coil.
Power handling capacity, 12 watts peak A.C.
Horn length: 2' 10".
Width: 2' 11". Price **£4:10s.**

SPECIAL HIRE TERMS FOR CORONATION

DEMONSTRATIONS of this and other GOODMANS Loudspeakers held every Thursday Evening at the Wembley Works between 6 p.m. and 7 p.m. (5 mins. from Wembley L.M.S. and Bakerloo St., and Buses). Other demonstrations by appointment.

COUPON

Post to-day in unsealed envelope (½d. stamp) to:—
GOODMANS INDUSTRIES LTD., Lancelot Road, Wembley, Middx.

If you desire Technical Bulletin and Response Curves for High Fidelity Auditorium Loudspeakers, enclose 3d. stamps.

Name

Address

W.W. 9/4/37.

FOR THE CORONATION



The

GRAMPIAN 18WATT Complete PUBLIC ADDRESS EQUIPMENT

A variety of entertainment can be provided with this general purpose amplifier—microphone, gramophone music, or radio! The reproduction is of the high order for which Gramphian Equipment is renowned.

The Amplifier circuit employs a High mag. Triode feeding an 8 watt Output Pentode, which is used as a driver stage to drive Class B output valves in parallel. These valves are twin stages; the output stage thus really consists of 6 valves. Tone Control, Microphone-Pickup and Volume Controls are fitted and provide a smooth fade. Hum level is particularly low, the equipment can be used on poor mains without interference.

WORKS OFF:
12 VOLT BATTERY,
A.C. MAINS,
D.C. MAINS.

PROGRAMMES
From
RADIO,
GRAMOPHONE or
MICROPHONE.

COMPLETE WITH
ONE PROJECTOR
SPEAKER, BUILT-
IN RADIO PANEL,
DYNAMIC MICRO-
PHONE.

PRICE COMPLETE
with 30 ft. leads, plugs,
all necessary controls
and fittings.

43 Gns.
List.

Extra
Projection
Speakers

£6 : 15s. List.

CONVENIENT DEFERRED TERMS.

WRITE TO-DAY FOR FURTHER PARTICULARS.

GRAMPIAN REPRODUCERS, LTD., Kew Gardens, Surrey

Telephone: Richmond 1175.

Export Enquiries Invited.

GRAMPIAN

PUBLIC ADDRESS EQUIPMENT.

Mention of "The Wireless World," when writing to advertisers, will ensure prompt attention.

MISCELLANEOUS ADVERTISEMENTS

NOTICES

THE CHARGE FOR ADVERTISEMENTS in these columns is

12 words or less, 3/- and 3d. for every additional word.

Each paragraph is charged separately and name and address must be counted.

SERIES DISCOUNTS are allowed to Trade Advertisers as follows on orders for consecutive insertions, provided a contract is placed in advance, and in the absence of fresh instructions the entire "copy" is repeated from the previous issue: 13 consecutive insertions 5%; 26 consecutive, 10%; 52 consecutive, 15%.

ADVERTISEMENTS for these columns are accepted up to **FIRST POST ON MONDAY MORNING** (previous to date of issue) at the Head Offices of "The Wireless World," Dorset House, Stamford Street, London, S.E.1, or on **SATURDAY MORNING** at the Branch Offices, 19, Hertford Street, Coventry; Guildhall Buildings, Navigation Street, Birmingham, 2; 260, Deansgate, Manchester, 3; 266, Renfield Street, Glasgow, C.2.

Advertisements that arrive too late for a particular issue will automatically be inserted in the following issue unless accompanied by instructions to the contrary. All advertisements in this section must be strictly prepaid.

The proprietors retain the right to refuse or withdraw advertisements at their discretion.

Postal Orders and Cheques sent in payment for advertisements should be made payable to **ILIFFE & SONS Ltd.**, and crossed **& Co.** Notes being untraceable if lost in transit should not be sent as remittances.

All letters relating to advertisements should quote the number which is printed at the end of each advertisement and the date of the issue in which it appeared.

The proprietors are not responsible for clerical or printers' errors, although every care is taken to avoid mistakes.

NEW RECEIVERS AND AMPLIFIERS

A. DEGALLIER'S, Ltd., the firm for reliable short wave radio, have on show in London the largest selection of fully guaranteed brand new all-wave receivers; callers invited to handle all these at their leisure without obligation to purchase; all S.W. receivers will get stations on the low bands, including the Americans, etc. Hours of business 11 a.m.-7 p.m. Closed all day Mondays. All goods cash with order or c.o.d. Handsomely illustrated catalogues forwarded on receipt of large stamped addressed envelope or stamp 2/4d. Our models receive American transmissions at full programme strength; demonstrations daily after 4.30.

VALVES, every one-brand new, not seconds or rejects. Even if it is not shown here we have it. 01a, 1a6, 1c6, 1f4, 1v, 2a3, 2a5, 2a6, 2a7, 2b7, 5z3, 6a4, 6a6, 6a7, 6b7, 6c6, 6d6, 6e5, 6f7, 6g5, 10, 12a, 12a5, 12a7, 12z3, 12z5, 15, 19, 22, 24, 25s (1b5), 25z5, 26, 27, 30, 31, 32, 33, 34, 35 (use 51), 36, 37, 38, 39-44, 41, 42, 43, 45, 46, 47, 48, 49, 50, 51, 53, 55, 56, 57, 58, 59, 71a, 75, 76, 77, 78, 79, 80, 81, 82, 83, 83V, 84 (6Z4), 85, 89, 99V, 99X, P.Z., P.Z.H., Wunderlich Glass Counterparts, 5W4g, 5Y3, 6A8G, 6X5G, 6B6, 25A6G, 6CSG, 25Z6g, 6F5G, 6H6G, 6J7G, 6K7G, 6L7G, 6N6G, 6V7G, 6P7, 6Q7G, 6R7G, 25N6G. Metal Valves, 5Z4, 6a3, 6b5, 6c5, 6f5, 6h6, 6j7, 6k7, 5Y3, 5W4, 617, 6n6, 6n7, 6q7, 6r7, 6x5, 25a6, 25z6. All metal replacement types for glass valves, 2a6, 24, 27, 51, 55, 56, 57. All the above 6/6 each. Line cords for any Midget receiver, 4/9 each.

£3/10—TR.F. Midget receiver. "The smallest of its type in the world," medium and long wavebands, moving coil speaker, 2 watts output, no earth required, compact and transportable, leather cloth covered, obtainable in various colours; carriage 1/-.

£7/7—Table model six-valve all-wave superhet, tuning 16 $\frac{1}{2}$ -50, 200-550, 800-2,000 metres, high efficiency resistance-capacity circuit with A.V.C., station calibrated dial, 8in. moving coil speaker, cabinet of handsome appearance and super acoustic, 17x13x9 $\frac{1}{2}$, operates on A.C. or D.C. mains, 200-250 volts; never before such tone from a D.C. receiver, carriage 4/6.

13 Gns.—The new Challenger 8 (type 800) table model De Luxe, 22x18x12, high fidelity 8-valve superhet, A.C. 200-250 volts, waveband coverage 11-32, 27-65, 190-550, 800-2,000 metres, simplified centralised tuning, super slow motion vernier slow-fast tuning dial calibrated in metres, with station names, self contained control panel, perfect tone quality at low volume, new type, M.C. 10in. speaker, from a whisper to 8 watts pure undistorted tone, no overloading at full volume, oscillator fundamental without use of harmonics, persistent oscillator of highest output, isolating filters eliminate oscillation and motor boating, fully delayed A.V.C., P.U. terminals (switching and volume control incorporated in the front panel), absolute minimum of noise, sensitivity control for noise suppression. Reinforced capacitors prevent drift, pre-aged intermediate frequency transformers, I.F. barrier discs, anchor coil leads, plug-in loudspeaker, moisture sealed out by tropical zone impregnation, self heating electrolytic condensers. One complete chassis of

(This advertisement continued in third column.)



REMINDERS

No. 1. Don't forget that the **HARTLEY-TURNER P.M. SPEAKER** is still the best on the market *except* the Duode de Luxe.

No. 2. Make an appointment to call and hear the **M.A. RECEIVER**—the only one we know of that gives Hartley-Turner quality, and also gets distant stations. The first batch is now being despatched—they are all sold. But the second is being laid down, and we shall soon be able to deliver from stock. If your movements are uncertain, and you don't want to make an appointment, then

No. 3. Remember that for a little longer we are still keeping open for demonstrations from 6 to 10.30 every Wednesday and Thursday.

No. 4. This is a nasty one. We have to remind you that all the prices shown in our leaflets have now been increased 10%. Please don't think we are greedy—it is simply that most of our materials are up 20%, or more.

No. 5. In case you have forgotten how to get to us, here is our little map again: this time cut it out for reference.



No. 6. If you can't call on us make a note to send for any of our new leaflets that interest you: they are

"New Notes in Radio," not new but with a new supplement: Price 6d. each, Vols. I and II, or if you have them, 3d. post free for the supplement.

1937 Loud-speakers.
Radio-Gramophones.
S.A. Chassis.
M.A. Chassis.
Whistle Rejector.
Hartley-Turner A.F. Coupling Units.



HARTLEY TURNER RADIO LTD.,
THORNBURY ROAD,
ISLEWORTH, MIDDLESEX.
Telephone: HOUnslow 4488

NUMBERED ADDRESSES

For the convenience of private advertisers, letters may be addressed to numbers at "The Wireless World" Office. When this is desired, the sum of 6d. to defray the cost of registration and to cover postage on replies must be added to the advertisement charge, which must include the words Box 000, c/o "The Wireless World." All replies should be addressed to the Box number shown in the advertisement, c/o "The Wireless World," Dorset House, Stamford Street, London, S.E.1. Readers who reply to Box No. advertisements are warned against sending remittance through the post *except* in registered envelopes: in all such cases the use of the Deposit System is recommended, and the envelope should be clearly marked "Deposit Department."

DEPOSIT SYSTEM

Readers who hesitate to send money to advertisers in these columns may deal in perfect safety by availing themselves of our Deposit System. If the money be deposited with "The Wireless World," both parties are advised of its receipt.

The time allowed for decision is three days, counting from receipt of goods; after which period, if buyer decides not to retain goods, they must be returned to sender. If a sale is effected, buyer instructs us to remit amount to seller, but if not, seller instructs us to remit amount to depositor. Carriage is paid by the buyer, but in the event of no sale, and subject to there being no different arrangement between buyer and seller, each pays carriage one way. The seller takes the risk of loss or damage in transit, for which we take no responsibility. For all transactions up to £10, a deposit fee of 1/- is charged; on transactions over £10 and under £50, the fee is 2/6; over £50, 5/-. All deposit-matters are dealt with at Dorset House, Stamford Street, London, S.E.1, and cheques and money orders should be made payable to Iliffe & Sons Limited.

SPECIAL NOTE.—Readers who reply to advertisements and receive no answer to their enquiries are requested to regard the silence as an indication that the goods advertised have already been disposed of. Advertisers often receive so many enquiries that it is quite impossible to reply to each one by post. When sending remittances direct to an advertiser, stamp for return should also be included for use in the event of the application proving unsuccessful.

NEW RECEIVERS AND AMPLIFIERS

(This advertisement continued from first column.)

dreadnought construction. Moderate voltages assure full valve life. Economical to operate, 70 watts consumption. Correct valve selection, no compromise, no hum. Full weight transformers. True push-pull. Stabilised H.T. supply. Stabilised biases. Ceramic coil insulation. Fully loaded plate coils give maximum gain. Pre-balanced coil assembly. Sealed insulation, thin laminations of special silico steel, 7 k.c. selectivity. Fractional microvolt sensitivity. Shielded switching permits high gain. Positive silver plated contacts eliminates switch noises. Audio frequency range 30-8,000 cycles. Diode detection. Prizemone high fidelity. R.F. selector stages on all bands. Carriage 5/6.

£12/18—"800" chassis valves and 10in. speaker; carriage 4/-.

£14/18—"800" chassis valves and G.12 12in. Rola high fidelity speaker; carriage 6/-.

NOTE.—The Challenger 800 is available in A.C./D.C. 200-250 volts, employing 11 valves at an additional cost of 20/- on each model.

14 Gns.—Challenger 381 8-valve 14-2,060 metres. Polychromatic dial scale, improved vision master, beam power output, band spread Magna dial and second-hand magic eye tuning, automatic band indicator, high image frequency suppression, hair line selectivity, 5 k.c. separation; carriage 5/6; less cabinet, £13/18; carriage 4/-.

17 Gns.—Challenger 8 Console "800C" height 3ft. 6in., width 24in., depth 12 $\frac{1}{2}$ in.; this is the 800 chassis with G.12 speaker, carriage and crate, 10/-.

29 Gns.—Challenger "800R.G." radiogram, with automatic changer "Garrard", this job also incorporates the G.12 Rola; carriage and crate, 15/-; A.C./D.C. model, £2 extra.

DEGALLIER'S Ltd., 18, Connaught St., Marble Arch, London, W.2. Paddington 2745. [4127]

ALERT RADIO Co.
COMMUNICATION Receivers, all-wave chassis, complete receivers of all types, American valves, spares and service; we also have a few reconconditioned receivers.—21, East Rd., N.1. Clerkenwell 4871. [3737]

ROYAL RADIO Co.

ALL-WAVE Receivers, suitable for use on ships, as supplied to officers of many shipping lines.

OUR 8 and 10 Metal Valve All-wave Receivers; 15-2,000 metres, acknowledged by the trade as the best for range, tone, and general performance.

LATEST 6-valve Car Radio, A.V.C., remote control, no suppressors required.

A FULL Range of the World Famous Ferguson and Pilot Models Stocked.

ALL Sets Fully Guaranteed by Ourselves.

ALL Types of American Valves Stocked.

PAY Us a Visit Any Time, or send for full range catalogue; 1/4d. stamp will be appreciated.

ROYAL RADIO Co., 5, Buckingham Rd., South Woodford, London, E.18. Phone: Buckhurst 2756. [4111]

NEW RECEIVERS AND AMPLIFIERS

AIR KING.
ALL Models Feature Beam Tuning, Magic Eye indicator, gramophone pick-up connections, and special output valves.
ALL Sets Fully Guaranteed; H.P. terms available from 3/- per week.
WHOLESALE and Trade Enquiries Invited; generous terms.
ALL Types of American Valves Stocked; write for lists to
AIR KING RADIO, 115, Shaftesbury Av., Cambridge Circus, W.C.2. Phone: Temple Bar 4875 (2 lines). All receivers assembled in England. [3406]

ANGLO AMERICAN RADIO Offer the Finest Range of Bargains in Radio Chassis and Receivers.
2 Special Cash Bargains.—Limited number only; cash or c.o.d.; post 1/-, secure yours now.
37/6—Powerful 5-valve all-wave battery chassis, 12-2,000 metres, gramophone band-spread, 7 1/2 in. dial with short wave station names and map tuning scale. Complete with valves; an unprecedented offer.
21/-—Superheterodyne short-wave converters, 7-200 metres, 5 in. dial with band-spread, operates in front of any superhet or receiver with H.F. stage, mains or battery, complete with valves and cabinets, aerial tested.
4 D. in Stamps Enclosed Brings Our New Coronation Bargain Catalogue, 2 colours, fully illustrated; complete receivers 4v. A.C./D.C. to 10-valve 5 band. 10 watt at lowest prices in the country.
IF in Town Visit Our New Showroom and Coronation Display at Banham House, 39, New Oxford St.; full demonstrations without obligation.
ANGLO AMERICAN RADIO (AND MOTORS), Ltd. (Dept. W.12), Albion House, 59, New Oxford St., London, W.C.1. (Temple Bar 3231.) [4146]
"SERVICE With a Smile."

HENRY FORD RADIO, Ltd.
ELECTRONIC House, 22, Howland St., Tottenham Court Rd., W.1. Museum 5675. [0511]

HARMAUR RADIO for Wireless Receivers from £3/3; Raytheon glass and metal valves and all components; trade enquiries.
THE HARMAUR RADIO Co., Ltd., 8, Clifford St., New Bond St., London, W.1. [0499]

MCCARTHY New Series of A.C. Universal, Battery, All-Wave and other receivers; many refinements at no extra cost; several interesting new models.
IMPORTANT!—All prices quoted for McCarthy chassis include Marconi Royalty payments.
MCCARTHY All-Wave Battery Superhet, with R/F stage; £7; separate triode oscillator, L.F. stage, pentode output, ext. speaker and gram. sockets, etc., equals mains performance.—(See McCarthy advertisement, page 359.)
MCCARTHY 6-valve All-Wave Superhet, with R/F stage; £25/5; A.C. or Universal, iron-core I.F. coils, Litz-wound tuning coils, illuminated "Airplane" dial, triode-hexode frequency changer, double band-pass coupled I.F. amplifier, L.F. stage, pentode output, D.A.V.C., tone control, ext. speaker and gram. sockets; etc., etc., performance equals many 8-valve receivers.—(See McCarthy advertisement, page 359.)
MCCARTHY Super 9-valve All-Wave with Push-pull Triode Output; £12/12; 4 wave-bands (12.8-2,000 metres), R/F stage, triode-hexode frequency changer, 2 band-pass transformer-coupled I.F. amplifiers, double diode detector, L.F. amplifier, 5-6 watt output, D.A.V.C., tone control, ext. speaker, gram., etc., etc.
ALL McCarthy Receivers now on Heavy Cadmium-plated Steel Chassis; quality components and B.V.A. valves throughout.
MANY Other McCarthy Models. Write for complete catalogue.
MCCARTHY RADIO, Ltd., 44a, Westbourne Grove, London, W.2. [4126]
COUPLPHONE 6-valve All-Wave—Chassis, with R.F. stage, B.V.A. valves, 8 in. Rola speaker; £28/10, royalties paid; 12 months' guarantee, including valves.
COUPLPHONE RADIO MANUFACTURING Co., Ltd., Hutton, Preston. [4180]
CHASSIS, Peerless, latest American 9-valve, all wave, 8 1/2 in. speaker, £6/17/6; ditto 11 valves, 5 waves, 1938 model, 12 1/2 in. speaker, 18 watts, £11/11.—Kay, 1, Old Church Lane, N.W.9. [4183]
TRANS-ATLANTIC RADIO for Latest and Finest All-wave Receivers and Compacts from 59/6. "Philco" agents; radio repairs by experts.—Trans-Atlantic Radio Co., 15, Percy St., W.1. Museum 5096. [4095]
AMazing Midgels, 4 valves, A.C./D.C., portable, leatherette, colours, £3/5; valves, American, most types, 3/-, postage 3d.—Luke Radio, 165, Rushey Green, Catford, S.E.6. Hither Green 2864. [4178]
PILOT, Ferguson, Belmont, Pegasus, and Air King all-waves lead the field; our deliveries are prompt in original cartons, with full guarantees; your trade card will bring our wholesale catalogue from the authorised distributors.—Leonard Heys, 36, Henry St., Blackpool. [0530]
COMMUNICATION Receivers, Hammarlund, National, Hallcrafters, R.M.E.69, Tobe-Deutschmann; transmitters, Collins 45A, Peerless DX20, or built to order; American valves, microphones, Eddystone components.—A.C.S., Ltd., 52-4, Widmore Rd., Bromley. Phone: Ravensbourne 0156 [0550]

Notes
on the Suppression of Electrical Interference with Wireless Reception

No. 33.

SUPPRESSION FOR CAR RADIO AND ITS EFFECT ON ENGINE PERFORMANCE

The aerial is the greatest problem. With a coachbuilt body with wood or fabric roof the aerial can be situated there but with an all-metal body it must be outside and often the only practicable site is under the running board, taking advantage of every inch. Therefore a receiver must necessarily have a much greater degree of sensitivity than one for home use. This means that interference from the electrical equipment is generally severe and it is annoying that a given "cure" cannot by any stretch of imagination be said to apply to every make of car.

The worst sources of interference are the plugs and the generator. Suppressors are connected at the plug ends of the H.T. leads, the values of which should not exceed 15,000 ohms, and a further similar suppressor in series with the input to the distributor. Much has been written about the effect of these suppressors on the performance of the car, and once they have been fitted they are blamed for everything that is not just right. In fact, with new plugs they make no difference at all, but as plugs get older and a film forms of dirt, metal dust, and carbon, the resistance of the plug drops in relation to the suppressor in series; more voltage is dropped across the suppressor and less across the plug, resulting in a weak spark, and sometimes difficult starting, loss of power, etc. So long as you do not exceed 15,000 ohms in each lead and 15,000 in the input to the distributor, things are all right, provided always that that gives the necessary suppression. If greater suppression is required it may be necessary to put 15,000 ohms in each lead as it leaves the distributor, in which case you must be prepared to change your plugs more frequently as required.

The generator is dealt with by fitting a special .5 mfd. condenser between the brushes and "earth." Some modern cars have a voltage regulator to bring batteries on charge and to maintain a steady charge at all engine speeds. These may be exceedingly troublesome, but may be cured by the addition of a 0.02 mfd. condenser connected in the circuit not directly across the contacts but across contacts and coils. The windscreen wiper can be most troublesome, but on long and medium waves adequate suppression is obtained by fitting our standard windscreen wiper suppressor, one to each wiper. If it is desired to listen to short wave reception this suppressor is not sufficient, and two 0.01 condensers must be connected across the little motor with leads not exceeding one inch. This means either that the condenser must be housed under the wiper cover, or else the cover must be drilled to take the leads. Leads two inches in length do not give the necessary suppression.

- Car Kit, 4-cyl. (not including wiper suppressor) ... 15/6
 - 6-cyl. (not including wiper suppressor) ... 20/-
 - †No. 1241 Windscreen wiper suppressor with screened lead ... 10/6
- Write for authoritative literature on the subject "Interference Suppression," post free 1/2.



Belling & Lee Ltd.
 Cambridge Arterial Road,
 Enfield, Middx.
 Telephone: Enfield 3322.

RECEIVERS AND AMPLIFIERS
 CLEARANCE, SURPLUS, ETC.

HENRY'S.
1937 Regentone De Luxe Model A.C. 200-250 3 waveband Superhet. 5 valves, 17.5 to 2,000 metres, handsome cabinet; list 12 1/2 gns., our price £7.
1937 Regentone 3 Waveband, A.C. 200-250, 17.5 to 2,000 metres, thermometer tuning; list 9 gns., £4/10.
1936 Regentone 5-valve Consolette, A.C. 200-250, thermometer tuning; list £10/10, £4.
1937 Regentone 3-valve Battery Set, H.F. pentode, det. and pentode output, moving coil speaker, thermometer tuning; list £6/2/6, £3.
FARREX Short Wave Units for A.C. Mains or Battery Sets; list £3/3, only a few left for 30/-.
HENRY'S, 72, Wellington Av. London, N.15. Stamford Hill 2907. [4075]
CLEARANCE List (Trade Only).—Write Leonard Heys, 36, Henry St., Blackpool. [0527]
ARMSTRONG Co. Have a Further Few Soiled but Genuine Brand New Radio Chassis for Disposal at Considerably Less Than Cost Price, described hereunder.
ARMSTRONG Co. Offer 3 Only Genuine Armstrong 7-stage Superheterodyne Radiogram Chassis, perfect in every way, complete with British valves and brand new Rola F6 moving coil speaker, aerial tested and ready to switch on; 5 gns. each.
ARMSTRONG Co. Offer Several New 8-valve Radiogram Chassis, 4 wavebands from 12.9 metres; with radio frequency stage preceding triode-hexode frequency changer, 2 intermediate frequency transformer amplifiers, double diode triode and 2 PX4 push-pull output; all wavebands calibrated in station names; chassis, complete with Marconi and Mullard valves, 9 gns.
ARMSTRONG Co. Will Willingly Send Above on 7 Days' Trial, carriage and packing free.
ARMSTRONG MANUFACTURING Co., 100, King's Rd., Camden Town, N.W.1. [4181]
"WIRELESS World" 6-watts Undistorted Push-pull Amplifier, "B.T.H." "12in" "R.K." Speaker, complete; £8/15.—S.A.E., particulars, 9, Edison Ave., Romford. [4165]
"WIRELESS WORLD" Push-pull Quality Amplifier, with valves, Magnavox 66 speaker with transformer, Rothermel Tweeter speaker, feeder unit with valve for amplifier, Collaro, A.C./D.C. radio-gram. unit; £12/10; genuine.—S. W. Scott, 7, Selbourne Rd., Grimsby. [4156]

BATTERY CHARGING PLANT

WESTINGHOUSE R.G.C.1, 200-240v. A.C., cost £40, perfect condition, £18; ditto, 55 and 110, 1/2 amp. D.C. output, £3/10; Macfarlane C.P. type, output 22v. 75 amps. D.C. input 200-220v. A.C., cost £65, fine condition, £12/10; 2h.p. 200-220v. A.C. motor, with starter, ball bearings, £4; 6h.p. ditto, £4/10.—Mathers Bros., Sandy Lane North, Wallington. Phone: 4050. [4149]

PUBLIC ADDRESS EQUIPMENT

SPECIAL Offer!!!
81 Guinea Assembled; Vortexion 20 watt 4-stage P.A. amplifier, in steel case, 8in. x 10in. x 9in. high, with carrying handle, input with controls for microphone and pick-up and tone control, output for 7 1/2 and 15 ohm speakers, weight 25lb.; only 8 1/2 guineas, with valves.
4 Input Model, with mixers; £10.
HEAVERY Duty Model, as fitted to cinemas and dance halls; £25.
CALL and Hear the Rumble of an Organ as Never Before on our Wide Frequency Range Models, the best yet.
VORTEXION, Ltd., 182, The Broadway, Wimbledon, S.W.19. See our advertisement under New Mains Equipment. [3904]
DAVIS (SOUND SYSTEMS) Offer:—
FILLS LS Units; £7 each; list 15 gns.
TRUXOV P.M. Horn Units, type 6, £5/10; types 6a, £6; list price 15 and 16 gns. respectively. (All the above in perfect order).
QUANTITY of Large Truxov Horns, 7ft. 6in. air column, 3ft. 1in. dia., £4/10; 42in., 37/6.
7FT. 6in. Air Column Aluminium by Standard Telephones; £5.
DAVIS (SOUND SYSTEMS), 154, Hamlet Court Rd., Westcliff-on-Sea. [4208]

PARTRIDGE P.A. Manual, free to trade. See "Partridge Transformer" under "New Mains Equipment." [3487]
FOUR Marconi Shorthorn Projection Speakers for Disposal, recently overhauled; £16.—Harmony House, Southport. [4186]
HARMONY HOUSE SOUND SERVICE, Southport.—Beam power amplifiers, 14 watts output; £13/10 (subject); send for lists. [0546]
15-WATT Amplifier, A.C. operated Fader gramophone, mike, 11in. energised speaker; £18; trial.—Russell, Shrewsbury Av., Market Harborough. [4152]
FERRANTI A.C. 12c. 12-watt U.D.O. Amplifier, complete with two Gramplan P.A. speakers, mike and stand, Garrard auto changer, De Luxe outfit; a snip at £20.—Box 1356, c/o The Wireless World. [4150]
WANTED, Genemotor, 6 or 12v. to 400v. D.C.; sale, pair Marconi P.A. projector speakers complete, stands, £10; Genemotor 50v.-350v. D.C., 35/-; 110v. I.K.W. dynamo, £3.—Tate, Church St., Romsey, Hants. [4168]
AMPLIFIED Speech and Music for Fetes, sports meetings, etc., using our public address mobile equipments, also smaller equipments for dinners, dances, conferences, etc.—Harmony House Sound Service, Southport. [0548]

SPECIAL PUBLIC ADDRESS AMPLIFIERS

Our numerous friends will be pleased to know that we have obtained two major P.A. Contracts for the Coronation Celebrations.

We shall depend on our famous 30 watt Amplifiers to uphold our reputation on this momentous occasion and we respectfully suggest that all those interested in P.A. equipment should obtain further details of our 30 watt model. Better still, we should very much like to demonstrate this Amplifier to anyone interested.

Owing to its extreme sensitivity no Pre-stage Amplifier is required with the average Microphone, while its amazingly good frequency response and generous output coupled with the fact that we provide a Universal Output Transformer at an all in price of

£25 Complete With Valves MAKES THE S.S. 30 WATT A VERY ATTRACTIVE PROPOSITION.

May we send YOU further particulars?



SOUND SALES
MARLBOROUGH RD., UPPER HOLLOWAY, LONDON, N.19. (Contractors to the G.P.O., etc.)
LIMITED. Tel.: Archway 1661/2/3

The UNIVERSAL
AVOMINOR
REGD. TRADE MARK.
QUICKLY REVEALS EVERY FAULT
BRITISH MADE



"RADIO SERVICING SIMPLIFIED."
5th Edition.

A comprehensive survey of radio testing. Describes all faults that can develop in receivers and radio-graphs. Sets forth multitudinous tests in extremely straightforward manner. Explains the use of all testing instruments. 2/9 free

Deferred Terms if desired. (Leather Case, 10/-). **£5. 10**

Write for descriptive pamphlet to

The Automatic Coil Winder & Electrical Equipment Co. Ltd., WINDER HOUSE, DOUGLAS ST., LONDON, S.W.1. Phone: Vic.3404/7

USED SETS FOR SALE AND WANTED

HAYNES

HAYNES 2H.F. Unit and 14-watt Amplifier in Maker's Cabinet, quite new, gives perfect results, bargain; price, £22.—Lownds, The Cottage, Old Lenton, Nottingham. [4170]

MCCARTHY

MCCARTHY 6-valve, all-wave chassis, R.F. stage, list £8/10, used few hours only; first offer secures; Rola 10in. if required.—Box 1357, c/o The Wireless World. [4151]

MIDWEST

1936 Midwest 18 Valves Chassis and 12in. Loud Speaker, new condition; £18.—Freeman, 16, Fitzwilliam St., Sheffield. [4166]

MURPHY

"MURPHY" 1936 A.C. Radiogram, new condition; £17; offer.—112, Byron Rd., Reading. [4189]

MISCELLANEOUS

1937 Short-wave Eddystone Battery Superhet, 13.5-550m., two I.F. stages, A.V.C., 2½ watts, Q.P.P., walnut console, Goodmans auditorium speaker, world-wide reception, cost £21, accept £13; also Vidor all-wave sets, A.C., £4/17/6; battery, £3/17/6; Ekco 12v. car radio, £6. Phone: Lee Green 4561. [4164]

EXCHANGE OR WANTED

WANTED, Midget Universal Superhet; radiogram, A.C., all wave.—Hore, 56, Newbridge Hill, Bath. [4196]

G.L. Pocketphone Headphone Portable by Reid Manufacturing Co. Wanted.—Box 1387, c/o The Wireless World. [4167]

NEW MAINS EQUIPMENT

VORTEXION Quality Transformers.
VORTEXION Supply the B.B.C., G.P.O., L.P.T.B., I.C.I., Borough Councils, etc. Why not you?
ALL Fitted Screened Primaries, and tapped 200-250v. with centre tapped filaments, guaranteed one year.
W.W. Q.A. 425-0-425v. 120-160 m.a., 4v. 5-10a., 4v. 2.5a., 4v. 1-2a., 4v. 1-2a., super shrouded model; 32/-.
500-0-500v. 150 m.a., 4v. 4a., 4v. 2.5a., 4v. 2a., 4v. 2a., 4v. 2a., super shrouded model, 2.5% regulation, 35/-; open type, 32/-; 400 or 450v. same price.
350-0-350v. 120 m.a., 4v. 2-4a., 4v. 2-4a., 4v. 1a., 4v. 1a., super shrouded, 25/-; normal shrouded, 21/-; open type, 18/6.
350-0-350v. 75 m.a., 4v. 2-4a., 4v. 1-2a., shrouded, 18/-; open type, 16/-.
250-0-250v. 60 m.a., 4v. 2-4a., 4v. 1-2a., shrouded, 15/-; open type, 12/6.
AUTO Transformers. 100-120 to 200-240v.; 80 watts 11/., 120 watts 14/6, 200 watts 21/-, 500 watts 37/6.
CHOKES.—30h. 60 m.a., 7/6; 7-13h. 120 m.a., 12/6; 30h. 150 m.a., 15/-.
OUTPUT Transformers.—4-10 watt W.W. Q.A., 21/-; 20 watt super shrouded, 30/-.
VORTEXION Ltd., 182, The Broadway, Wimbledon, London, S.W.19. (Telephone: Liberty 2814.) [3951]

PARTRIDGE Transformers, as supplied to B.B.C., Marconi's, G.E.C., Mullards, I.C.I., Tunggram, etc.
SPECIALS Despatched Within 48 Hours; all standard types from stock.
SPECIAL Quotations to Manufacturers for Lots of 6 Upwards, hand wound, individually tested, immediate delivery, rock bottom prices.
TELEVISION Transformers Insulated to 10,000v. A.C., expert knowledge of transmitting requirements (mains and modulation).
HIGH Fidelity (20 to 15,000 Cycles) Intervolve and Output Transformers a Speciality.
PARTRIDGE P.A. Manual Free to Trade Only; contents includes constructional amplifiers, notes on microphone, pre-amplifiers, lines, mixing impedance matching speakers, etc.
PARTRIDGE, N., B.Sc., A.M.I.E.E., King's Buildings, Dean Stanley St., London, S.W.1. Phone: Vic. 5035. [3717]

TANTALUM for A.C. Chargers, H.T. and L.T.—Blackwell's Metallurgical Works, Ltd., Garston, Liverpool. [3984]

CABINETS

RADIOGRAM Cabinets, new designs, 30/- to £5/10; inspection invited or photos for selection sent on request.
TABLE Radio Cabinets, undrilled, 6/6 upwards.
SPEAKER Cabinets, 4/6 upwards.
MANUFACTURERS' Clearance.
BURGOYNE "Fury" Radiogram Cabinets (undrilled), 34x22x16¼; 49/6.
K.B. De Luxe Walnut Cabinets, undrilled, chromium plated edges and speaker grille, 25in. wide, 14½in. high, 10½in. deep, 18/6; Console model, 42in. high, 21½in. wide, 11½in. deep, 39/6.
HALOYON Radiogram Cabinets (Reconditioned), 33x23x19, 35/-.
H. L. SMITH and Co., Ltd., 287-9, Edgware Rd., London, W.2. Tel.: Pad. 5891. [0485]

ELECTRADIX BARGAINS

PUMPS AND COMPRESSORS.
Coronation Fountain Electric Pumps, for A.C. or D.C. mains. Centrifugal, all-bronze pump, 3ft. Hgt. 120 gals. per hour. For Gt. fountain, etc. 67/8. Larger pumps quoted for AIR COMPRESSORS for Paint Spraying, Set Cleaning, Inflation, etc. Foot Operated, 37/6. Electric No. 1 size, £6/15/- No. 2 Twin-cyl. £7/10/- A few S.H. Plants in good order, cheap.
MOTOR BLOWERS or EXHAUSTERS. Strong iron body, 3in. fan outlet, direct coupled to motor. D.C. 110 v., 45/-; D.C. 220 v., 55/- For air conditioning.
A BARGAIN IN DYNAMOS. Type "C" Our latest for Bunglow, Yacht or Cell Charging. 140 watt. Enclosed Dynamo, 12-20 v. 12 amps. Ball Bearings, Vee Pulley, 25/-.
Marine Type Switchboard with Ammeter, maximum and minimum Auto Cutout Mains Switch and Fuses, Field Regulator, 25/-.
MOTORS I MOTORS!
Tiny, Small and Medium horse-power. A large stock of really high-grade Motors and Converters for immediate delivery.
A.C. MAINS MOTORS.—Enclosed, self-start on load. A.C. commutator, 1/60 h.p. with pulley, Type 40, 1,500 revs., 18/6. Type 36, ditto, 1/25 h.p., G.E.C., 3,500 revs., 27/6. Induction 1/10 h.p., 2,500 revs., 35/- 1 h.p., self-starting, 1,425 revs., 48/- 6,000 revs., 35/-.
D.C. MAINS MOTORS.—1/40 h.p., Type 60, 220 v., K.B. series, 1,750 revs., 15/- Ditto, 1/40 h.p., G.E.C., 280 v. series, 2,000 revs., 16/- Ditto, 1/12 h.p., to 100 v. 1 amp. D.C. 60/-, 100 v., 15/- All fully guaranteed.
DOUBLE CURRENT DYNAMOS.—6 v. and D.C. 600 volts 100 m.a., 32/6
ROTARY CONVERTERS for A.C. sets on D.C. mains, 7-watt P.M. model, 35/- 15-watt 220 D.C./220 A.C. ball bearings, lam. field, silent running, enclosed, 65/- Larger sizes to 3 kW.
M.G. Sets with filter, 6 v. to 170 v., 25 m.a., for H.T., 65/- Dynamo and Switchboard, 12 v., 12 amps., 47/6.
A.C. to D.C. Motor Charges, all sizes in stock.
CORONATION ARC LAMP and FLOOD LIGHTS, Cable Resistances, etc. Porcelain Cleats, 6d. pair. ELECTRIC LIGHT, 1,000 Porcelain Ceiling Roses with Ramie Junction Connectors, 5/- doz.
DYNAMOS, MOTORS, ALTERNATORS and ROTARIES, Big Stock P.A. Sets, Amplifier Microphones and Speakers for outdoor use, 5 watts to 20 watts, at tempting prices.
METERS. Genuine Weston model 554. Central zero 1 to 15 a.n.p.s., pol. mag. dead beat. Flush panel, 2 1/2in. dial, nickel or black. Sale price 7/6. Mounted in solid mahog., 3 in. sq., B. Hoyt CZ mov. coil milliammeters, 25-0-25 m.a., 10/- Weston 0 to 30 m.a. mov. coil milliammeters, 17/6. 0-100 m.a., 17/8. Switchboard Meters all sizes.
MICRO-AMMETERS for Valve Voltmeters, etc. 0 to 50 microamps, full scale, 50 mV. moving coil, flush panel, 2 1/2in. dial. Reads direct signal strength on crystal, 1,000 ohms., 40/- See "Wireless World" report, page 158, August 14th issue.
OSCILLOGRAPH. Paul-Irwin 2-element thermo motor-driven prism, with shunts, condensers and plate camera. Overall mahog. base, 4ft. gin. cost £85. Sale £9/10/-; Suit College or Lab.
S.W. WAVEMETERS, 4 to 85 metres, £2/10/- McLaughlin Etc. W.W. 20 to 5,000 metres, £4. Gambrell, Type D. £2. Ditto, 75 to 12,000 metres, £2/15/- Sullivan Screened Het. to 16,000 metres, 65/-
FREQUENCY TEST RECORDS, 10in. cut to constant amplitude. Harmonic content under 5%, 2/6 each. FEIGH Home Recorders, 37/6.
MEGGERS and OHM-METERS, from £5/10/- Large Stock of Bridge Meggers and Recording Ammeters, cheap.
Send for New Illustrated Electrical Bargain List "W"

ELECTRADIX RADIOS
218, UPPER THAMES STREET, LONDON, E.C.4.
Telephone: Central 4611



IMPORTANT

Special Public Address Equipment for the CORONATION

The demand for high-grade public address equipment has already risen in anticipation of the May celebrations. With little over a month to go orders should be placed at once to ensure delivery and adequate site testing. Particulars of standard Savage equipments to suit your special needs will be sent immediately on receipt of details. Please let us know your requirements as early as possible.

W. BRYAN
SAVAGE
LTD.



WESTMORELAND ROAD, LONDON, N.W.9
PHONE: COLINDALE 7131 (3 LINES)

DYNAMOS, MOTORS, ETC.

All Types of Rotary Converters in Stock, new and second-hand. WARD, 46, Farringdon St., London, E.C.4. Telephone: Holborn 9705. [0518]
A.C.-D.C. New Motors, all voltages; from 14/9; lists free. -Repair Specialists, Easco Electrical Service, 18w, Brixton Rd., S.W.9. [0455]
M.L. Rotary, 230 D.C. to 230 A.C., 40 watts, 60/-; M.-Gen., 230 D.C. to 40v. 8 amps. D.C.; 55/-; owner moved A.C. district.-Walker, 615a, Watford Way, N.W.7. [4154]
ROTARY Converter, makers Yates, with filter unit in silence cabinet, type B, No. 18074, volts 220-110, r.p.m. 3,000, K.W.3 1/2; price 26; new condition.-R. & F. Roberts, Walton St., Long Eaton, Notts. [4173]

NEW LOUD-SPEAKERS

BAKER'S Quality Surplus Speakers.
HITHERTO Baker's Surplus Speakers Have Been Sold Through Agents; quality enthusiasts in search of a bargain can now obtain these speakers direct from our works. The following speakers are all brand new 1935-1936 models, and are offered at considerably under half list prices. If you are requiring Quality Reproductions at low cost, order one of the following exceptional bargains now. You will be amazed at the value obtained.
THE Auditorium Models are Fitted With Latest Triple Cone, comprising main curved cone and bakelite and duralumin cones combined, giving wide and even frequency response resulting in quality reproduction of both speech and music.
39/6 Only, usual price 45.-Auditorium Permanent Magnet Speaker, with Alni magnet and die cast frame, large 12in. triple cone giving wide frequency range, complete with large 25 ratio transformer suitable for all outputs, including push-pull and Class B, etc.
59/6 Only, usual price 76.-Auditorium Electro-Magnet Speaker, 1,000, 1,250, 2,000 or 2,500 ohms field, exceptionally large magnet of high permeability steel giving enormous flux density, 2in. moving coil, large triple cone giving wide frequency range, complete with universal transformer, the ideal speaker for use with "Wireless World" and other quality amplifiers.
75/- Only, usual price 89.-As above, but for use on A.C. mains; complete with Westinghouse rectifier and full smoothing equipment.
24/- Only.-Permanent Magnet Speaker, Alni magnet, die cast frame, 10in. cone, Universal transformer.
15/6 Only.-Permanent Magnet Speaker, Alni magnet, 8in. cone, Universal transformer.
12/6 Only.-Permanent Magnet Speaker as above, with 7in. cone.
2/9 Only.-Brand new cabinets, 12x10x6
8/6 Only.-Electro-Magnet Speakers, with 8in. cone, 6,500 ohms field, Universal transformer.

ALL Baker Quality Surplus Speakers are Sold for Cash or C.O.D.
BAKER'S SELHURST RADIO, Ltd., The Pioneer Manufacturers of Moving Coil Speakers, 1925-1937, 75-77 Sussex Rd., South Croydon. (Croydon 3441). [3892]
VAUXHALL.-Best quality speakers; see other column. -Vauxhall Utilities, 163a, Strand. [4204]

LOUD-SPEAKERS

SECOND-HAND, CLEARANCE, SURPLUS, ETC.
VAUXHALL.-Magnavox mains energised, 2,500 or 6,500 field coil, 10in. cone, 17/6; 7in. cone, 12/6.
VAUXHALL.-Magnavox permanent magnets, universal, suitable for Class "B" power or pentode, 7in. cone, 16/6; 10in. cone, 22/-.
VAUXHALL.-American Rolas, 2,500, 8in., 15/-; 9 3/4in. 19/6. Permanent magnets, 8in. 19/6, 9 3/4in. 24/6.
VAUXHALL.-Above, fully guaranteed, complete with humbucking coils; state power or pentode transformer; unused manufacturers' stock.
VAUXHALL.-Immediate delivery, carriage paid; lists free; cash with order or c.o.d.-Vauxhall Utilities, 163a, Strand, W.C.2. Temple Bar 9338. [4205]
HARTLEY-TURNER Baffle, 21in. x 21in. x 21in., list 23/7/6.-Offers to Blackmore, 6, Doughty St., W.C.1. [4179]
VOIGT Domestic-Speaker, as new, 45s model; 19 gns. or part exchange towards small car.-Box 1403, c/o The Wireless World. [4201]

VALVES

ANDERSON.
AMERICAN Valves, all makes, first grade only; 5/- each.
ANDERSON, 35, Lansdowne Rd., Walthamstow, E.17, Walthamstow 0827. [3351]
3/- Each.-6L6, 6K7, 6H6, 25Z6, 25A6; all other popular types American tubes.
RADIOGRAPHIC, Ltd., 66, Osborne St., Glasgow, C.1. [4038]
"CHAMPION" American Valves (R.C.A. licensed), 69 various types stocked; write for list; special discount to trade dealers.
THE UNIVERSAL RADIO Co., 221, City Rd., London, E.C.1. [4026]
AMERICAN Valves, first grade, in all types; trade supplied.-Metropolitan Radio Service Co., 1021, Finchley Rd., N.W.11. Speedwell 3000. [0436]

ALL Types of American Valves in Stock of Raytheon, A. Sylvania, and Arcurus makes, at competitive prices, guaranteed for six months; send for full list; 350 ohms line cords, 2/8.
WARD, 46, Farringdon St., London, E.C.4. Tel.: Holborn 9703. [0452]
NOTHING Better Available. Six months' guarantee, complete range of battery, A.O. mains, rectifiers, always in stock, 2 volt det., H.F., L.F., 2/3; Power, 2/9; screen grid pentode, H.F. pentode, 5/-; American types, six months' guarantee, 5/6 each, Nos. 18, 24A, 35, 42, 43, 45, 47, 56, 57, 58, 75, 77, 78, 80, 2A5, 2A6, 2A7, 6A7, 2B7, 6B7, 6C6, 6D6, 25Z5, 25Y5.-Write for other prices to Dulci Electrical Co., Devonshire Works, Duke's Ave., Chiswick, London, W.4. [0501]

PREMIER SUPPLY STORES

Offer the following Set Manufacturers' Brand New Surplus Goods at a Fraction of the Original Cost; all goods guaranteed perfect; carr. paid over 5/-; under 5/- postage 6d. extra. Orders under 5/- cannot be sent C.O.D. ALL POST ORDERS TO

JUBILEE WORKS, 167 LOWER CLAPTON RD., LONDON, E.5

CALLERS, AS USUAL, TO 165 & 165a, FLEET ST., E.C.4 (Next door to Anderson's Hotel). Central 2833. New Branch;—50, HIGH STREET, CLAPHAM, S.W.4 (Macaulay 2381).

Have you had our GIANT ILLUSTRATED CATALOGUE AND VALVE LIST? Send 4d. IN STAMPS FOR THIS BARGAIN LIST.

MAINS VALVES, famous Europa 4 v. A.C. types, 4/6 each. H.L., L. S.G., Var.-Mu-S.G., H.F.-Pens., Var.-Mu-H.F. Pens. 1, 3 and 4-watt A.C. directly heated output Pentodes. A.C./D.C. types. 20-volt 18 amp. S.G., Var.-Mu-S.G., H., H.L., Power and Pen.
Following types all 5/6 each. Full-wave rectifiers, 350 v. 120 m.a. and 500 v. 120 m.a. 2 1/2 watt indirectly-heated Pentodes, Octodes, Frequency Changers.
BATTERY VALVES. 2 volts, H.F., L.F., 2/3. Power, Super-Power, 2/9. S.G., Var.-Mu-S.G., 4- or 5-pin Pentodes. H.F. Pens. V.-Mu-H.F. Pens., 5/- Class B, 3/6.
AMERICAN VALVES. Genuine American HYTRON and TRIAD first-grade Valves. 3 months' guarantee. All types in stock, 5/6 each. 210 and 250, 8/6 each. New Metal-Glass Valves, all types, 4/6 each. Genuine American DUOTRON Valves, all types, 3/6 each. Valve holders for all above types, 6d. each. Octal bases, 9d. each.
SHORT-WAVE COILS, 4- and 6-pin types, 13-20, 22-47, 41-94, 78-170 metres, 1/9 each, with circuit. Special set of 3-4 Pin S.W. Coils, 14-150 metres, 4/- set, with circuit. Premier 4-pin 3-band S.W. Coil, 11-25, 19-43, 38-88 metres. Suitable any type circuit, 2/6. COIL FORMERS, in finest plastic material, 1 1/2in. low-loss ribbed, 4- or 6-pin, 1/- each.
SUPER CERAMIC CONDENSERS, S.L.F., .00016, .0001, 2/3 each; double-spaced, .00025, .00015, 3/- each. All brass with integral slow motion, .00015 tuning, 3/9; .00015 reaction, 2/9.
H.F. CHOKES, S.W., 10-200 metres, 9d.; S.W. screened, 1/6; standard screened, 180-2,000 metres, 1/6.
ELECTROLYTICS. U.S.A., 4 or 8 mfd. 530 v. peak, 1/9 each. Dubilier, 4 or 8 mfd. 500 v., 3/-; 50 mfd. 50 v., 1/9; 10 mfd. 50 v., 6d.; 25 mfd. 25 v., 1/-; T.C.C. 4 or 8 mfd. 650 v., 4/-; 15 mfd. 50 or 100 v., 1/-; 50 mfd. 12 v., 1/6. Paper Condensers. W.E., 250 v. working 4 mf., 2/-; 1 mfd. 1/-; 1 mfd. 6d.; 350 v. working 4 mf., 2/6; 2 mf., 1/6. Dubilier 500 v. working 4 mf., 4/-; 800 v. 4 mf., 6/-.

Kit with long-life valve rectifier (replacement cost only 2/-). PREMIER L.T. CHARGER KITs for A.C. mains, including Westinghouse Rectifiers and Tapped Mains Transformers 8 volts at 1/2 amp., 14/6; 8 volts 1 a. 17/6; 15 volts 1 a., 19/-; 8 volts 2 a., 29/6.
TELSEN iron-cored screened coils, W.340, 4/- each. Electric SOLDERING IRONS, 200-250 v., A.C./D.C., 2/3. NEW 1937 1-VALVE SHORT-WAVE RECEIVER OR ADAPTOR KIT, 13 to 80 metres without coil changing. Complete Kit and Circuit, 12/6. VALVE GIVEN FREE! DE LUXE MODEL 14 to 150 metres complete Kit with Chassis, 4 Coils and all parts, 17/6.
1937 SUPERHET CONVERTER KIT, 13/6. DE LUXE MODEL, 18/0. S.W. SUPERHET CONVERTER, for A.C. Mains Receivers, 20/-; A.C. Valve given FREE! NEW 1937 2-VALVE S.W. KIT, 13 to 86 metres without coil changing. Complete Kit and Circuit, 19/6. VALVES GIVEN FREE. DE LUXE MODEL, 14 to 150 metres, complete Kit and Chassis, 4 Coils and all parts, 25/-; VALVES GIVEN FREE. 3-VALVE S.W. KIT, S.G., Det. and Pen., 42/-; VALVES GIVEN FREE!
BAND-PASS TUNING PACK, comprising set of Telsen 3-gang iron-cored coils with switching, mounted on steel chassis with 3-gang condenser, illuminated disc-drive and 4 valve holders, 25/- the lot. All Mains or Battery circuit. FREE!
SPECIAL OFFER. LISSEN TWO-GANG SCREENED ALL-WAVE COILS, 12 to 2,000 metres, complete with switching and wiring diagram, 6/11 per set.
3 VALVE BAND-PASS KIT, 200-2,000 metres. Complete kit of parts, including chassis, all components, valves, M.C. speaker and wiring diagram. Battery Model, 50/-; A.C. Mains Model, 70/-.
MAGNAVOX. Mains energised M.C. Speakers. '154', 7in. cone, 2,500 ohms, 2,500 ohms, 17/6; '152' Magna', 9in. cone, 2,500 ohms, 37/6. Magnavox P.M.s.—'254', 7in. cone, 16/6; '252', 9in. cone, 22/6. Reliable P.M.s., 10/6. TELSEN P.M.s. with 10 ratio transformers, 12/6. TELSEN Speaker Units, 2/6. ROLA latest type P.M.s., 15/-. GOODMANS' 8in. mains energised 1,000 ohms field, 10/6 each. Jensen P.M.s., 10/6. B.T.H. ENERGISED MOVING COIL, 10 1/2" diam., 1,650 ohms field. Power, or Pentode Transformer. (State which.) SPECIAL LINE at 14/6.
Potentiometers by well-known makers. All values up to 1 meg., 2/-; with switch, 2/6. GRAMOPHONE MOTORS. Collaro Gramophone Unit consisting of A.C. motor, 100-250 v. high quality pick-up and volume control, 45/-; Collaro motor only, 30/-; Collaro Universal Gramophone Motor, 100-250 v. A.C./D.C., with high quality pick-up and volume control, 67/6; Collaro Universal Motor only, 49/6; Edison Bell double-spring motors, including turntable and all fittings, 15/-; Cosmocord Gramo. unit, comprising A.C. motor pick-up and volume control (list 55/-), 35/9.
TUBULAR CONDENSERS, non-inductive, all values up to .5 mfd., 6d. each.
Wire-end RESISTORS, any value, 1 watt, 6d.; 4 watts, 1/-; 8 watts, 1/6; 15 watts, 2/-; 25 watts, 2/6 each. Reliable MORSE KEYS with Morse Code engraved on bakelite base, 2/- each. Bakelite case BUZZERS, 1/6. Walnut case "Loud-tone," 2/6 each.
Super Quality lightweight HEADPHONES, 3/9 pair. UTILITY 3-GANG CONDENSERS, fully screened, with trimmers, 4/6 each. PREMIER FILAMENT TRANSFORMERS, 4 v. 3 a., C.T., 7/6; 4 v. 5 a., C.T., 8/6; 5 v. 3 a., 7/6; 6.3 v. 3 a., 7/6; 7.5 v. 3 a., 7/6; 2.5 v. 8 a., 8/6.

CORRECTION. In the Belling-Lee advertisement of last week's issue, dealing with British Standard Specification No. 727 ("the characteristics and performance of apparatus for the measurement of radio interference") it was stated that the Belling-Lee measuring instrument incorporated "variable attenuators." With a concession to the compositor's possible preoccupation with Easter holidays, the advertisers point out that the measuring set does not include attenuators (nor turbines!). What the equipment does provide, inter alia, are "variable attenuators" totalling 136 db. in 6 db. steps.

TANNOY THE SOUND PEOPLE GUY & FOUNTAIN LTD. FOR CANTERBURY GROVE, WEST NORWOOD, ALL LONDON, S.E.27. Phone: Str. 1122 (6 lines). SOUND AMPLIFYING EQUIPMENT

ENGINEERS! ARE YOU EARNING LESS THAN £10 PER WEEK? If so, you cannot afford to carry on without reading our 268-page Handbook. The book explains clearly and definitely many ways of carving out a successful career. Among other things, it explains the Services of our unique Appointments Department; outlines Home-Study Courses in all branches of Civil, Mechanical, Electrical, Motor, Aero, Wireless, "Talkie," Engineering, Building, Govt. Employment, etc., and gives details of B.Sc., A.M.I.C.E., A.M.I.E.E., A.M.I.Mech.E., A.M.I.A.E., A.M.I.W.T., A.M.I.R.E., G.P.O., MATRIC, and all Exams. We Guarantee—"NO PASS—NO FEE." Whether you be an old hand or a budding apprentice, get this book to-day—FREE and POST FREE. BRITISH INSTITUTE OF ENGINEERING TECHNOLOGY, 387 Shakespeare House, 17/19, Stratford Place, London, W.1.

PATENTS

BRITISH Patent No. 405117, improvements in or relating to electric filters.
BRITISH Patent No. 405281, improvements in telegraph or telephone systems using in part sound or elastic waves as the agency of communication.
BRITISH Patent No. 405613, improvements in and relating to the directive discrimination of sound beams.
BRITISH Patent No. 405620, improvements in magnetostrictive vibrators.
THE Proprietor of the Above British Patents is desirous of arranging by way of licence or otherwise for the working of these inventions on a commercial scale in this country.—For particulars write to Stanley Popplewell and Francis, Chartered Patent Agents, 88-90, Chancery Lane, London, W.C.2. [4169]

TUITION

RADIO Training—Marine, aircraft, broadcast; prospectus free.—Hull Municipal Technical College. [0523]
PRACTICAL Radio and Television, private or postal training; particulars free.—R.T.L., 39-47, Earl's Court Rd., W.8. Western 6917. [3758]

WANTED

SPOT Cash for Modern Sets and Components—Economic Radio, 96-98, South Lambeth Rd., S.W.8. [3942]
WANTED—Good make set tester in good order, state make, price.—Box 1407, c/o *The Wireless World*. [4209]
TRANSFORMERS, meters, testing equipment, etc.; write details and price.—Grigs, 70, Peel Rd., Wealdstone, Middlesex. [4195]
FERRANTI and Weston Meters Wanted; also clean modern components; best prices paid.—Newport Surplus Stores, 24a, Newport Court, Charing Cross Rd., W.C.2. Ger. 2791. [4191]
WANTED, back numbers of "Wireless Engineer" and "Experimental Wireless," between December, 1935, and 1926; state price and years available.—Bourdillon, 22, Frogmal Lane, Hampstead, N.W.3. [4157]
WE Buy for Cash All Types of Modern Second-hand Radio Sets and Accessories, test meters, parts, etc.; we pay more than any other dealer; part exchanges; bring, send, or will call.—University Radio, Ltd., 82, Hampstead Rd., London, N.W.1. Phone: Euston 3810. [4193]

SITUATIONS VACANT

AIR MINISTRY.
DIRECTORATE of Technical Development.
ASSISTANTS, Grade II (two posts) required at the Royal Aircraft Establishment, South Farnborough, Hants, to assist in experimental laboratory work connected with aircraft radio equipment.
CANDIDATES should have sound general knowledge of the basic principles of Communication Engineering. A course of technical education up to the standard of the I.E.E. examination, or its equivalent, is desirable. It is necessary that candidates should have had two or three years experience in experimental research or design work in connection with communication equipment. Experience solely in broadcast receiver servicing or on production test lines is not acceptable.
CANDIDATES must be physically fit for flying and willing to fly as observers.
SALARY Scale: £315 plus £12 annually for approved service, to £385 a year (men). £265 plus £12 annually for approved service, to £315 a year (women).
THE Appointments will be non-pensionable, but eligible posts in the event of vacancies arising on the pensionable establishment.
APPLY (quoting Ref. 342/C), and stating age and full particulars of training and experience, to the Chief Superintendent, Royal Aircraft Establishment, South Farnborough, Hants.
THE Closing Date for the Receipt of Applications is 23rd April, 1937. [4163]

L.R.S.

We are still specialising in
QUALITY APPARATUS
 M.C. SPEAKERS, PICK-UPS, Etc., including
Hartley-Turner
Sound Sales
Magnavox
McCarthy
Midwest
Haynes
 and KITS for all "Wireless World" designs on

CONVENIENT TERMS

The BEST costs very little more on our generous terms—and the BEST QUALITY, purchased out of income, is better than indifferent quality for cash.
 Whatever your requirement, write us for particulars and a quotation will be sent by return of post.
 All transactions are strictly confidential
 Estd. - 1925 Phone NATIONAL 1977

THE LONDON RADIO SUPPLY COMPANY
 11 OAT LANE · NOBLE ST · LONDON EC2

BE SAFE... NOT SORRY!

We supply everything in radio, at **RIGHT PRICES**, plus our guarantee of satisfaction or money refunded.

RADIOGRAPHIC LTD.
 66, Osborne Street, GLASGOW.
 Telephone: Bell 848.

THE MOTOR CYCLE

The Motor Cyclist's Newspaper

EVERY THURSDAY—3d.

Publishers: LILFFE & SONS LTD., Dorset House, Stamford Street, London, S.E.1 w.w.15

SITUATIONS VACANT

RESEARCH Engineers Required For:—
(A) Television.
(B) Electrical Instruments.
APPLICANTS should be 25-35 Years of Age and have had good previous experience in one of the above headings.—Written applications only with comprehensive report on training, experience and age, to A. C. Cossor, Ltd., Employment Office, Highbury Grove, N.5. [4184]
SMART Junior Radio Service Engineer, sales experience, progressive position; references.—E. C. E., Ltd., 197, Kingston Rd., Ewell, Surrey. [4210]
RESIDENT Wireless Technical Instructor Wanted for New Southampton College, write fullest particulars stating age, salary expected.—Principal, Wireless College, Calmore, Southampton. [4161]
WIRELESS—All students placed; Marconi approved school; G.P.O. licence; fees after training; boarders accepted.—Dept. W/W., Wireless School, 21, Manor Gardens, Holloway, N.7. [4085]
YOUTHS for Wiring and Assembling and Service Work; progressive positions in radio and amplifier firm in South London; good rates and prospects.—Box 1391, c/o *The Wireless World*. [4176]
WORKSHOP Foreman for Radio and Amplifier Construction Works; able to organise production and control staff; write, stating experience, salary; South London district.—Box 1390, c/o *The Wireless World*. [4175]
WIRELESS Operators and Engineers Urgently Required.—Train at Britain's leading colleges; fee after appointment; boarders; prospectus free.—The Wireless College, Colwyn Bay, or The Wireless College, Calmore, Southampton. [0541]
RADIO Manager Required by Large Works, A1 man only, age 40-50, thoroughly experienced in engineering, manufacturing and market trends; give full particulars of experience, age, present salary and salary expected; enclose small unmounted photograph.—Box 1373, c/o *The Wireless World*. [4162]
RADIO and Television Technical Assistant; able to design test gear and use initiative, control staff, urge production for high class radio manufacturer in South London; permanent, progressive position for right man; write, stating experience and salary required.—Box 1392, c/o *The Wireless World*. [4177]
DRAUGHTSMEN Required by Large Radio Manufacturers, with good all round experience covering layout and detailing of piece parts and assemblies, progressive positions for right type of men.—Apply by letter only, to the Labour Supervisor, Mitcham Works, Ltd., new Rd., Mitcham Junction. [4185]
RADIO Engineers—Mitcham Works, Ltd., have two vacancies in the receiver laboratory for competent engineers with experience of receiver design, measurements and factory testing methods.—Apply, by letter only, giving details of experience, etc., to the Labour Supervisor, at New Rd., Mitcham Junction, Surrey. It is not possible to interview without appointment. [4155]
ARE You Tired of Poorly Paid Routine Work? If so, why not be a salesman? We are regularly introducing our trained students to salaried posts as outdoor salesmen; you can qualify for this well-paid progressive work by spare-time home study, after which we will introduce you to salaried posts.—Write for free copy of our 32-page book, "Salesmanship," to The Wallace Attwood College, Ltd., Dept. 80, Victoria House, Southampton Row, London, W.C.1. [4174]

SITUATION WANTED

TALKIE Engineer, age 25, own car and equipment, desires change of life, more excitement and better prospects.—Box 1365, c/o *The Wireless World*. [4158]

INDEX TO ADVERTISEMENTS

All-Power Transformers, Ltd.	PAGE 7
Armstrong Mfg. Co.	
Automatic Coil Winder Co., Ltd.	4
Bakers Selhurst Radio	
Belling-Lee, Ltd.	5
Birmingham Radiomart G5N1	3, 6
British Institute of Engineering Technology	5
British Insulated Cables, Ltd.	Back Cover
British Pix	
British Rola Co., Ltd.	Edit. 363
British Sound Recording	
British Thomson-Houston Co., Ltd.	
Bulgin, A. S., & Co., Ltd.	
C.A.V.	
Cossor, A. C., Ltd.	
"Drydex"	
Dubilier Condenser Co. (1925), Ltd.	Inside Front Cover
Ediswan, Ltd.	Front Cover, Inside Back Cover
Electradix Radios	4
Exide, Ltd.	
Fluxite	

Forbat, Eugene J.	PAGE
Gardners Radio, Ltd.	
Goodman's Industries, Ltd.	1
Gramplan Reproducers, Ltd.	1
Hartley Turner Radio, Ltd.	
Haynes Radio	2
Imhof, Alfred, Ltd.	
Institute of Wireless Technology	
Lectro Linx	
Lingaphone, Ltd.	
London Radio Supply Co.	8
Marconi's W. T. Co., Ltd.	
McCarthy Radio, Ltd.	Edit. 359
Midwest Radio, Ltd.	Inside Back Cover
M.P.R. Electrical Co.	
Musikon, Ltd.	
Parneko, Ltd.	
Peto Scott, Ltd.	7
Pitman, Sir Isaac, & Sons, Ltd.	
Player's Cigarettes	

Premier Supply Stores	PAGE 5
Prism Manufacturing Co.	
Radio Development Co.	
Radiographic, Ltd.	8
Record Radio, Ltd.	8
Savage, W. Bryan	
Scott Sessions, Ltd.	Back Cover
Sound Sales, Ltd.	4
Stern, S.	
Tannoy Products	5
Telegraph Condenser Co.	Edit. 361
Tungram Electric Lamp Works (Great Britain), Ltd.	
Universal Radio Distributors, Ltd.	
Vortexion, Ltd.	
Ward, C. F.	
Waverley Book Co., Ltd.	
Westinghouse Brake & Signal Co., Ltd.	
Wharfedale Wireless	
Wingrove & Rogers, Ltd.	Inside Back Cover
Wright & Weaire, Ltd.	8

WEARITE ALL-WAVE OSCILLATOR UNIT

Covers all wavelengths from 15 M. to 3,000 M. in 7 ranges (harmonics not used).

MODULATION. May be switched off and external modulation used when required.

SHIELDING. Minimum leakage, no appreciable energy reaches the set.

STABILITY. Calibration permanent for all variables.

Price **£7.15.0**

● Free booklet on returning this announcement to:—
WRIGHT & WEAIRE, LTD.,
 740, High Road, Tottenham, LONDON, N.17.

RECORD

The quality valve in the
COMPLETE range

RECORD RADIO LTD., 2/3, Eldon Street, E.C.2

Printed in England for the Publishers, LILFFE AND SONS LTD., Dorset House, Stamford Street, London, S.E.1, by The Cornwall Press Ltd., Paris Garden, Stamford Street, London, S.E.1. "The Wireless World" can be obtained abroad from the following: FRANCE: W. H. Smith & Son, 248, Rue Rivoli, Paris; Hachette et Cie, Réaumur, Paris, and branches. BELGIUM: W. H. Smith & Son, 74-75, Boulevard Adolphe Max, Brussels. AUSTRALIA: Gordon & Gotch, Ltd., Melbourne (Victoria), Sydney (N.S.W.), Brisbane (Queensland). ADELAIDE (S.A.), Perth (W.A.), and Launceston (Tasmania). NEW ZEALAND: Gordon & Gotch, Ltd., Wellington, Auckland, Christchurch and Dunedin. INDIA: A. H. Wheeler & Co., Bombay, Allahabad and Calcutta. CANADA: Imperial News Co., Toronto, Winnipeg and Vancouver; Benjamin News Co., Montreal; Gordon & Gotch, Ltd., Toronto. SOUTH AFRICA: Central News Agency, Ltd. UNITED STATES: The International News Co., New York.

THE ACCUMULATOR THAT REVELS IN HARD WORK —

POPULAR SIZES
 R.A.I.—30 Amp. hrs. 7/3
 R.A.I.—60 Amp. hrs. 9/6
 R.A.I.—90 Amp. hrs. 12/3

THE EDISON SWAN ELECTRIC CO. LTD.
 PONDERS END, MIDDLESEX BA300

EDISWAN EXTRA LIFE ACCUMULATORS

FREE ART CATALOGUE DEMONSTRATIONS 40 pages, fully illustrated, giving particulars of Midwest 11, 14, 16, and 18 valve models. at our showrooms Mondays to Saturdays from 9 a.m. to 8 p.m. (except Tuesdays, 9 a.m. to 6 p.m.)

1937 MIDWEST

Magnificent alike in its conception, design and performance, this the latest Midwest Model X-18 High Fidelity Receiver brings the world to your fire-side. With its 6 TUNING RANGES it gets "Everything on the Air." Its distinctive features in circuit design are not just "talking points," as a comparison will prove, but basic advantages which will assuredly appeal to "Wireless World" readers and all who appreciate Studio or Concert Hall quality of performance in the home.

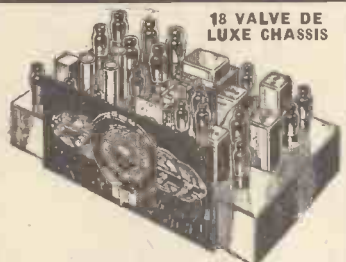

THE ONLY ALL-WAVE RECEIVER COVERING 4½ to 2,400 METRES
 Available in Chassis form complete with matched valves and 12" speaker or in Console Cabinet.

MIDWEST RADIO Ltd.
 Showrooms and Factory:
 16, Old Town, Clapham, London, S.W.4.
 'Phone: MACaulay 5305.

SECOND EDITION — Completely Revised
RADIO DATA CHARTS A SERIES OF ABACS

Providing most of the essential Data required in receiver design.

By R. T. BEATTY, M.A., B.E., D.Sc.

PRICE 4/6 net BY POST 4/10

From all leading booksellers, or direct from the Publishers. Published from the offices of "THE WIRELESS WORLD," DORSET HOUSE, STAMFORD STREET, LONDON, S.E.1 W.W.9.

POLAR & N.S.F. COMPONENTS

POLAR BAR TYPE GANG CONDENSERS

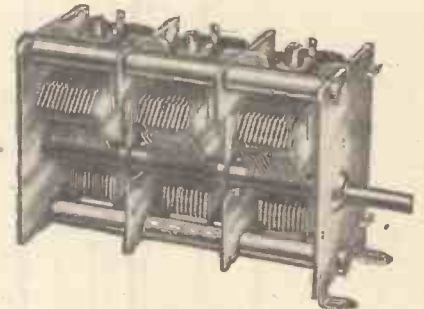

Steel frame ensuring great rigidity. Aluminium vanes. Low minimum capacity. Accurately matched. Available with ceramic insulations, 2/- 2-gang and 2/6 3-gang extra.

Two Gang or Superhet Type..... 12/-
 Three Gang or Superhet Type..... 17/6

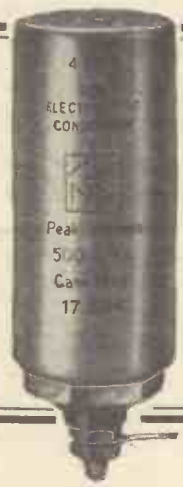

Specified for the "SHORT WAVE CONVERTER"

POLAR—N.S.F. ELECTROLYTIC CONDENSERS

Highest Quality Materials. Low power factor, low leakage, constant capacity. Peak voltage 500 v. D.C.

ONE REQUIRED... 4 mfd..... 4/6
 ONE REQUIRED... 8 mfd..... 5/6

POLAR—N.S.F. TUBULAR CONDENSERS

Non-inductive. High insulation. Low power factor. Tested at 1,500 volts D.C. Working 350 volts D.C.

.0001.....	.02.....	} 1/4
.0003.....	.05.....	
.0005.....	.1.....	
.001.....	.2.....	} 1/9
.002.....	.25.....	
.005.....	.5.....	} 2/-
.01.....		

● Send for fully illustrated catalogue of Polar and N.S.F. Condensers.

WINGROVE & ROGERS LTD.
 188/189, Strand, London, W.C.2

'Phone: Temple Bar 2244. Works: Old Swan, Liverpool

Mention of "The Wireless World," when writing to advertisers, will ensure prompt attention.

SECOND EDITION

—THOROUGHLY REVISED

WIRELESS SERVICING MANUAL

By W. T. COCKING

(of "The Wireless World")

The first complete book of reference of its kind. A reliable practical guide for amateur and professional.

The demand for this book was so great that the first edition was sold out in the short space of a very few months. A second edition containing additional material is now on sale.

The "Wireless Servicing Manual" deals fully with Testing Apparatus and explains the methods of locating and curing faults in receiving equipment.

Ganging, Automatic Volume control, Instability, Distortion, Mains Hum, Whistles and Local Interference are all separately treated.

The new edition contains much additional information on short-wave receivers, and on methods of operating extension loud speakers, the reference material including base-connections for British, Continental and American Valves, and the various colour codes for components has been extended and brought up to date.

BOUND IN CLOTH BOARDS

SIZE 7½ ins. x 5 ins.

231 PAGES

PRICE 5/- net. By post 5/4

Issued in conjunction with "THE WIRELESS WORLD" and Published by the Proprietors:—

ILIFFE & SONS LTD., DORSET HOUSE, STAMFORD STREET, LONDON, S.E.1

TUDOR 4101



SCOTT-SESSIONS SHORT WAVE CONVERTERS

Recognised the World Over for Real "SUPER-QUALITY" in WORKMANSHIP and PERFORMANCE whether Designed and Constructed by them or Built to Satisfy Individual Requirements.

Scott-Sessions would be happy to quote you for the construction of the

SHORT WAVE CONVERTER DESCRIBED IN THIS ISSUE

including the supply of all materials constructed with Finest Quality Workmanship, Ganged on Precision Oscillator, and Signal Generator. Or alternatively to quote for the complete Kit of Parts.

SCOTT-SESSIONS & CO.
EXCHANGE WORKS, DUKES AVENUE,
MUSWELL HILL, LONDON, N.10

For Super-Quality Wireless Work of any and every description

Note: To ensure First-Class Reception of all CORONATION BROADCASTS why not have your present equipment thoroughly over-hauled by us?

Phone TUDOR 4101 for PROMPT ATTENTION.

B.I. RESINKOR SOLDER AND CORALINE PASTE



B.I. Resinkor Solder, which carries its own flux, is supplied in 9-in. sticks, in coils of 1 to 20 S.W.G. weighing up to 28 lbs., and all but the largest sizes can also be supplied on reels. For use with ordinary solder, B.I. Coraline Soldering Paste is excellent. It gives off no spray or fumes, does not run or dry, and is very economical, as only a trace is required. Sold in tins from 1 oz. to 7 lbs.

BRITISH INSULATED CABLES LTD.

Cable Makers and Electrical Engineers

PRESCOT, LANCs.

Telephone No.: PRESCOT 6571

London Office: SURREY HOUSE, EMBANKMENT, W.C.2

Telephone No. Temple Bar 7722.

The

Wireless World



4^D

THE PRACTICAL RADIO & TELEVISION JOURNAL

Friday, April 16th, 1937.

IMPORTANT to Colpak users and set constructors.

Constructors will be interested to note that the Technical Staff of Colvern Limited have specially designed a short wave superheterodyne converter unit for use in conjunction with the Colpak receivers or an existing set employing at least one stage of H.F. amplification.

free!

Full details are available, price 3d. Please state whether for Mains or Battery working.

Name

Address

If you would like a copy of our Ferrocart booklet, please put a X here.....

COLVERN LTD., Mawneys Rd., Romford, Essex.

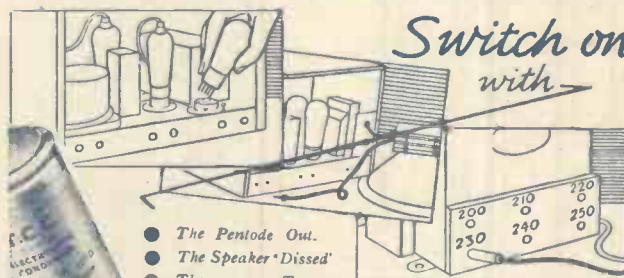

- The Pentode Out.
- The Speaker 'Dissed'
- The wrong Transformer tapping used

BUT YOU WON'T DAMAGE YOUR SET IF YOU USE

T.C.C. SURGE PROOF WET ELECTROLYTICS

The Telegraph Condenser Co. Ltd., Wales Farm Road, N. Acton, W.3.

CA 19867

Everything for

QUALITY RECEPTION



Everything for the

TELEVISION CONSTRUCTOR

Duophase amplifier 6-watt, Duophase amplifier 6-watt for P.M. speaker, Duophase amplifier 14-watt, Duophase amplifier 14-watt (constructor's model), Duophone amplifier circuits, Duophase intervalve coupling, gramophone amplifier 6-watt, gramophone amplifier 14-watt, 1-H.F. tuner unit, 2-H.F. tuner unit, all-wave tuner unit, shortwave converter, table model receivers, radiogramophones, schools receivers, baffle boards, loud speakers, volume controls, mains transformers, smoothing and filter chokes, output transformers

Originators of the Quality Receiver and Quality Radiogramophones.

Demonstration night every Friday, 7.30-9.30 p.m.

Time base transformers, time base units, H.T. transformers up to 6,000 volts, heater transformers, smoothing and voltage regulating equipment, high voltage rectifiers, cathode ray tubes and holders with protecting front screen, converter units for speech reception, complete apparatus for vision receiver construction, chassis and special baseplates.

The most attractive development ever presented to the radio enthusiast.

Have you the Haynes Quality Booklet? 1936-37 Edition. Free on request.

Howard 1171.

HAYNES RADIO LIMITED, QUEENSWAY, ENFIELD, MIDDLESEX.

They're pleasing more smokers all the time

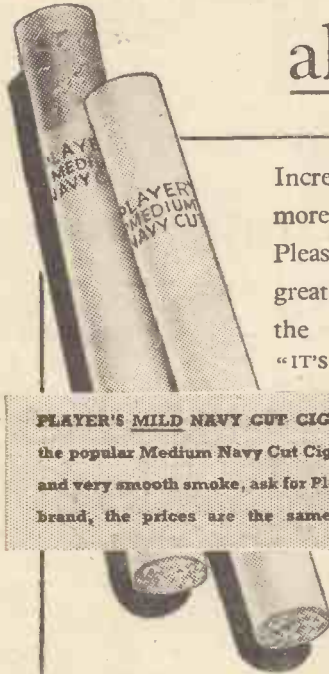

Increasing sales show that more and more smokers are saying "Player's Please"—convincing proof that the great majority realise and appreciate the truth of the Player maxim "IT'S THE TOBACCO THAT COUNTS"

PLAYER'S MILD NAVY CUT CIGARETTES are not so well known as the popular Medium Navy Cut Cigarettes, but if your taste is for a mild and very smooth smoke, ask for Player's "MILD." An old established brand, the prices are the same as for "Medium" 10-8d, 20-11½d.

FLAIN OR CORK TIPPED



PLAYER'S 'MEDIUM' NAVY CUT CIGARETTES NCC-386A

1937 MIDWEST

Magnificent alike in its conception, design and performance, this the latest Midwest Model X-18 High Fidelity Receiver brings the world to your fire-side. With its 6 TUNING RANGES it gets "Everything on the Air." Its distinctive features in circuit design are not just "talking points," as a comparison will prove, but basic advantages which will assuredly appeal to "Wireless World" readers and all who appreciate Studio or Concert Hall quality of performance in the home.

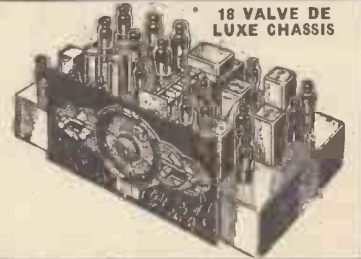

18 VALVE DE LUXE CHASSIS

FREE ART CATALOGUE DEMONSTRATIONS 40 pages, fully illustrated, giving particulars of Midwest 11, 14, 16, and 18 valve models. at our showrooms Mondays to Saturdays from 9 a.m. to 8 p.m. (except Tuesdays, 9 a.m. to 6 p.m.)

★ **THE ONLY ALL-WAVE RECEIVER COVERING 4½ to 2,400 METRES** Available in Chassis form complete with matched valves and 12" speaker or in Console Cabinet. **MIDWEST RADIO Ltd.** Showrooms and Factory: 16, Old Town, Clapham, London, S.W.4.

The Yachting World and Motor Boating Journal

The Leading British Yachting Journal

"THE YACHTING WORLD" deals with yachts and boats of all types and tonnages, whether on the sea or inland waters. Every aspect of yachting and motor boating is covered in an attractive and interesting manner.

Every Friday 6^d.

ILIFFE & SONS LTD., Dorset House, Stamford St., London, S.E.1
w.w.8r

DICTIONARY of WIRELESS TECHNICAL TERMS

Compiled by S. O. Pearson, B.Sc., A.M.I.E.E., and issued in conjunction with "THE WIRELESS WORLD." Second edition. Completely revised.

This handy volume is very much more than a Dictionary. It not only takes the technical terms of wireless and explains their meaning, but in doing so it concentrates into a small space a large amount of information on wireless subjects. It has become, in fact, a compendium of wireless knowledge, and an invaluable handbook for all who are interested in wireless transmission and reception. Diagrams and illustrations are freely interspersed throughout the book to amplify the explanations of the text.

272 pp., bound in clothboards
Size 5 by 3 inches.

Price 2/- net. By post 2/2

From all leading booksellers or direct from the Publishers
ILIFFE & SONSLTD., DORSET HOUSE, STAMFORD STREET, LONDON, S.E.1

Facsimile Page
from the
Second Edition

Impulse Excitation. Method of starting high-frequency oscillations in an aerial system or oscillatory circuit by a sudden surge, e.g., a spark, and not by applying an oscillating voltage of the same frequency as that of the tuned circuit. Sometimes called "shock excitation."

In Phase. Two alternating quantities are said to be "in phase" if they have the same frequency and pass through their respective maximum and zero values at the same instants. The definition applies only where the two waves

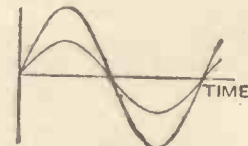

Sine waves in phase.

are of the same shape. See PHASE DIFFERENCE.

Indirectly-heated Valve. The type of valve in which the cathode is indirectly heated by a separate heater resistance, the cathode being a hollow cylinder to accommodate the heater within it. The heater may be supplied with A.C. or D.C.

Induced Current. A current produced in a circuit by an induced E.M.F., i.e., by a changing of the magnetic flux linked with the circuit.

The Wireless World

THE
PRACTICAL RADIO
JOURNAL
27th Year of Publication

No. 920.

FRIDAY, APRIL 16TH, 1937.

Vol. XL. No. 16.

Proprietors: ILIFFE & SONS LTD.

Editor:
HUGH S. POCOCK.

Editorial,
Advertising and Publishing Offices:
DORSET HOUSE, STAMFORD STREET,
LONDON, S.E.1.

Telephone: Waterloo 3333 (50 lines).
Telegrams: "Ethaworld, Sedist, London."

COVENTRY: Hertford Street.
Telegrams: "Autocar, Coventry." Telephone: 5210 Coventry.

BIRMINGHAM:
Guildhall Buildings, Navigation Street, 2.
Telegrams: "Autopress, Birmingham." Telephone: 2971 Midland (4 lines).

MANCHESTER: 260, Deansgate, 3.
Telegrams: "Iliffe, Manchester." Telephone: Blackfriars 412 (4 lines).

GLASGOW: 26B, Renfield Street, C.2.
Telegrams: "Iliffe, Glasgow." Telephone: Central 4857.

PUBLISHED WEEKLY. ENTERED AS SECOND
CLASS MATTER AT NEW YORK, N.Y.

Subscription Rates:
Home, £1 1s. 8d.; Canada, £1 1s. 8d.; other
countries, £1 3s. 10d. per annum.

As many of the circuits and apparatus described in these
pages are covered by patents, readers are advised, before
making use of them, to satisfy themselves that they would
not be infringing patents.

CONTENTS

	Page
Editorial Comment	365
AC Short-wave Converter—Con- structional Details	366
The Future of Television	370
Unbiased	372
Current Topics	373
Listeners' Guide for the Week	374
The Television Receiver VII	376
Contrast Expansion—Further Notes	378
Broadcast Brevities	379
Short Wave Stations of the World	380
On the Short Waves	382
Letters to the Editor	383
G.E.C. AC Transportable 5	384
Random Radiations	386
Recent Inventions	388

EDITORIAL COMMENT

Empire Broadcasting

A Progressive Policy

IT will be recollected that the Broadcasting Committee presided over by Lord Ullswater which, in 1936, presented its Report and Recommendations on the future conduct of broadcasting, especially recommended that the Empire Broadcasting Service should be authorised in the new B.B.C. Charter and that additional funds required for its development should be provided by the Corporation from its increased share of licence receipts.

This recommendation for the fuller recognition of the Empire Broadcasting Service and its value is already bearing fruit. The B.B.C., with the co-operation of the Marconi Company and Standard Telephones and Cables, have designed the most powerful group of short-wave transmitters in Europe, and these are now nearing completion.

Sir Noel Ashbridge, Chief Engineer of the B.B.C., made public a few days ago some details regarding these new developments and an account of them appears elsewhere in the pages of this issue. These developments are particularly gratifying to us because in them we see the fulfilment of those objects which we had in view when years ago, in spite of opposition, we urged that an Empire Broadcasting Service on short waves should be established.

Now that so much has been done towards improving the service at the transmitting end, it is time to express the hope that the authorities in the Dominions and Colonies will be prepared to take the initiative to improve reception conditions at their end. Reception with individual short-wave receivers will, no doubt, always remain the most popular arrangement, but there is also scope for much more to be

done in the way of establishing reception centres on lines similar to the B.B.C. station at Tatsfield, in order that the Empire transmissions may be received under conditions as ideal as possible, and the output from these receivers fed to local transmitters and so received on standard sets. Such an arrangement is by no means new; it was adopted in connection with the Dutch short-wave transmitter set up for broadcasting to the Dutch East Indies a good many years ago, and since that time there is a wealth of experience with such arrangements to draw upon, particularly in connection with the B.B.C. receiving centre at Tatsfield. The establishment of such centres in the Dominions and the Colonies need, therefore, no longer be regarded as experimental and uncertain in results.

The use of a local relay system to be fed from a receiving centre may also commend itself in many instances, more particularly where the population is fairly concentrated.

In the House

Answers to Wireless Questions

REPLIES were given in the House of Commons last week to two questions of special interest to our readers.

The Assistant Postmaster-General stated that a Bill to give effect to the recommendations of the Committee on Electrical Interference was under consideration, although no hope could be held out that it would be introduced this session.

Replying to another question, the Assistant P.M.G. said that additional revenue for the B.B.C. from the licence receipts would come from the Treasury if at any time they were satisfied that the income of the B.B.C. was insufficient for their services, including Television and Empire Broadcasting.

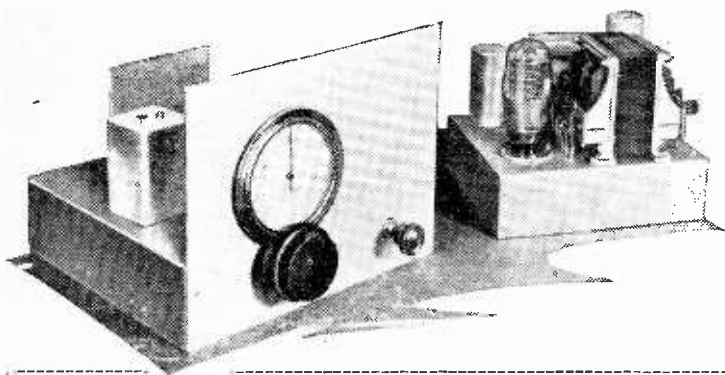

AC Short-Wave

Constructional Details, Preliminary Adjustments, and Operating Notes

By H. B. DENT

THIS converter, which is AC operated and has a separate power unit, can be used with any type of broadcast receiver. Last week the construction of the coil box was dealt with, and in this instalment the complete assembly, adjustment, and operation are described.

BEFORE giving attention to the assembly of the converter there is a small detail in connection with the coil unit that may require a few words of explanation. In order to limit the oscillator output on Range 2 and Range 3 parallel resistances are joined across the circuit. These are marked R8 and R9 respectively. In the theoretical circuit diagram they are shown joined across the trimmer condensers C16 and C17 respectively.

In the original model the resistances were the small half-watt type, and it was found more convenient to join them to the two connecting tags on the coil formers. Though not, therefore, absolutely in accordance with the theoretical circuit they, nevertheless, serve the same purpose, as for merely damping the circuit it is quite immaterial whether they shunt the coil only or the whole circuit.

Should longer resistances than those used be fitted it may be found more convenient in wiring to connect them from one tag on the coil formers to the parallel trimming condensers C16 and C17 on the opposite side of the compartment.

In regard to the construction of the converter the first procedure is to make up or to assemble the chassis from parts that can be obtained cut and bent to size.

The chassis is a little unorthodox as the coil box, though a separate unit, actually forms an integral part of it, being bolted to one side and serving also to position the front panel. When this is finished the two condensers C4 and C11 can be mounted, the former on a metal bracket measuring 4in. x 4in. and the latter on an insulated one consisting of a piece of ebonite or Paxolin to which has been fitted a piece of angle brass.

This insulated bracket and the metal one below the chassis that carries the valve-holder must be assembled together, as the same fixing screws are used for both. With the condensers in position the dial can be assembled on the front panel and the whole correctly lined up. Next mount the group board carrying the resistances R4,

R5 and R7, and condensers C6 and C8 so that it stands far enough away from the chassis to clear the driving disc on the dial. Short lengths of 6BA screwed rod are used for this.

At this stage it would be advisable to uncouple the dial and condensers, leaving the latter in position, and remove the front

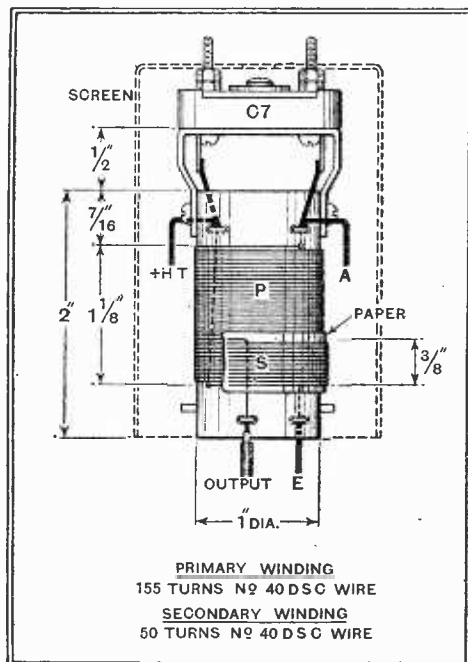

Constructional details of the IF transformer are given above, and on the right is shown the finished unit with the screening can removed.

panel, as by doing so the pins on the valve-holder become much more accessible for wiring.

For the time being the output transformer can be omitted unless it has already been made or acquired, in which case it can be assembled on the chassis. Its construction will be dealt with later.

As will be seen from the drawings and the illustrations, the wiring of the converter is quite a simple matter and does not require much explanation save in con-

nection with the filament of the valve. Only one lead is taken from the heater pins to the terminal block at the back, as the other pin of the valve is joined direct to the chassis.

In cases where the heater wiring is carried out in the more orthodox manner it is usually necessary in short-wave apparatus to join a condenser from each filament pin to the earth line, to prevent modulation hum. By adopting the scheme used in the present case these condensers become unnecessary, and since their capacity must be at least 0.1 mfd, the saving of these two components is worth while.

It must be remembered, however, that should an existing power pack be employed, and there is no objection to this course provided it gives the required voltages, then the centre tap on the filament winding must be disconnected from the earth line or one half of the heater winding will be short-circuited.

In order to obtain the best possible results from the frequency-changer it was decided to tune the anode circuit of the valve to the intermediate frequency and feed the IF output from a step-down

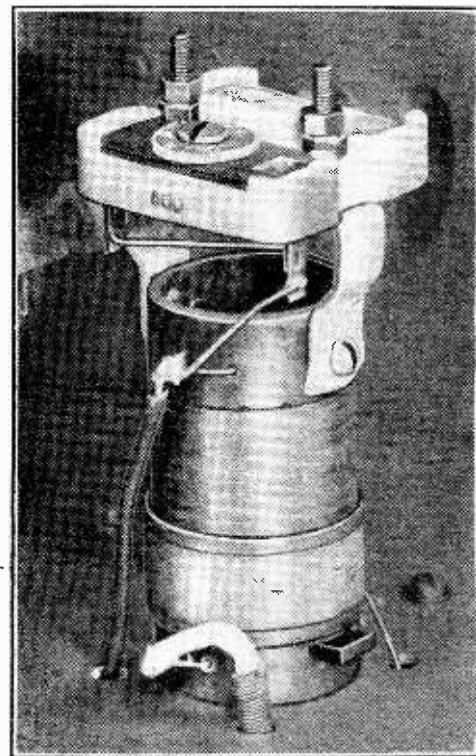

secondary winding through a screened lead to the aerial terminal of the broadcast set. The step-down ratio adopted is approximately 3 to 1.

Constructional details of this trans-

Converter

THREE-RANGE UNIT COVERING 12.5 TO 62.5 METRES

(Concluded from last week's issue)

former are given in the drawings. It consists of a 2 in. long former 1 in. in diameter, and it is wound with No. 40 SWG DSC wire. The primary winding is $1\frac{1}{2}$ in. long, and about 155 turns can be accommodated in this length. A thin coating of shellac can be applied, and when dry three or four layers of stout gummed paper $\frac{1}{2}$ in. wide are wound over the earth, or lower, end. The secondary is wound on this paper strip, and consists of 50 turns of No. 40 SWG DSC wire, and it should occupy $\frac{3}{4}$ in. in length.

At the start the winding is laid lengthwise along the former with the free end towards the bottom end, and a piece of the gummed paper, about $\frac{1}{2}$ in. square, is used to secure it. The winding is then commenced from the top end, and wound over the stuck-on paper. At the finish a second piece of paper can be used to secure the end. If the coil is then given a thin coat of shellac, the turns will be securely fixed when the coil is dry.

The primary winding of this coil is tuned by a Hunt's mica trimming condenser of 0.0005 mfd., and, with about three-quarters of the total capacity, will tune to 550 kc/s, approximately 550 metres, which is the IF chosen for the converter.

Intermediate Frequency

There are several reasons that have influenced the choice of this particular frequency. If the IF is too low—i.e., 150 kc/s (2,000 metres)—pulling between the signal circuit and the oscillator is inclined to be troublesome, and if too high—i.e., 1,500 kc/s (200 metres)—there is a risk of the harmonics generated in the oscillator of the broadcast set, assuming a superhet. is employed, beating with the short-wave oscillator and producing what appears to be unmodulated carrier waves at various tuning positions of the short-wave unit. The actual frequency adopted is a compromise between these two extremes. It means, of course, that the broadcast set has to be tuned to the top end of the medium-wave band.

When the assembly has been completed and the power pack built, the actual construction of which will not be discussed since it is quite straightforward, the wiring should be carefully checked, and if everything be found in order the valves can be fitted and the final adjustments made.

It is advisable to examine the ganged condensers and couplers to make sure that both are being driven by the dial, and that when the pointer is at 100 on the scale the moving vanes of both condensers are fully in mesh with the fixed vanes.

If the initial test be made in the evening it would be advisable to start with range three, for which the waveband switch is turned to the third position in a clockwise

direction. This range should tune from 36.6 metres (8.2 Mc/s) to 62.5 metres (4.8 Mc/s), and the adjustments are effected on the two trimmers C3 and C17, signal and oscillator circuits respectively. C17 will require to have very nearly the full capacity available, so that this trimmer

still to be adjusted for the correct coverage.

Possibly the best point to take on this range as a key position is 50 metres (6 Mc/s), where the Moscow station RNE is usually found operating. The actual wavelength of Moscow is 49.99 metres (6.001 Mc/s), and it is a good strong signal.

This should tune in on the converter at 48.1 on the scale, and C17 and C3 can be adjusted in turn to give the strongest signals.

The short-wave broadcast stations in the 6 Mc/s band which extends from 44.1 to 50 metres, 6.8 to 6 Mc/s, are tuned in

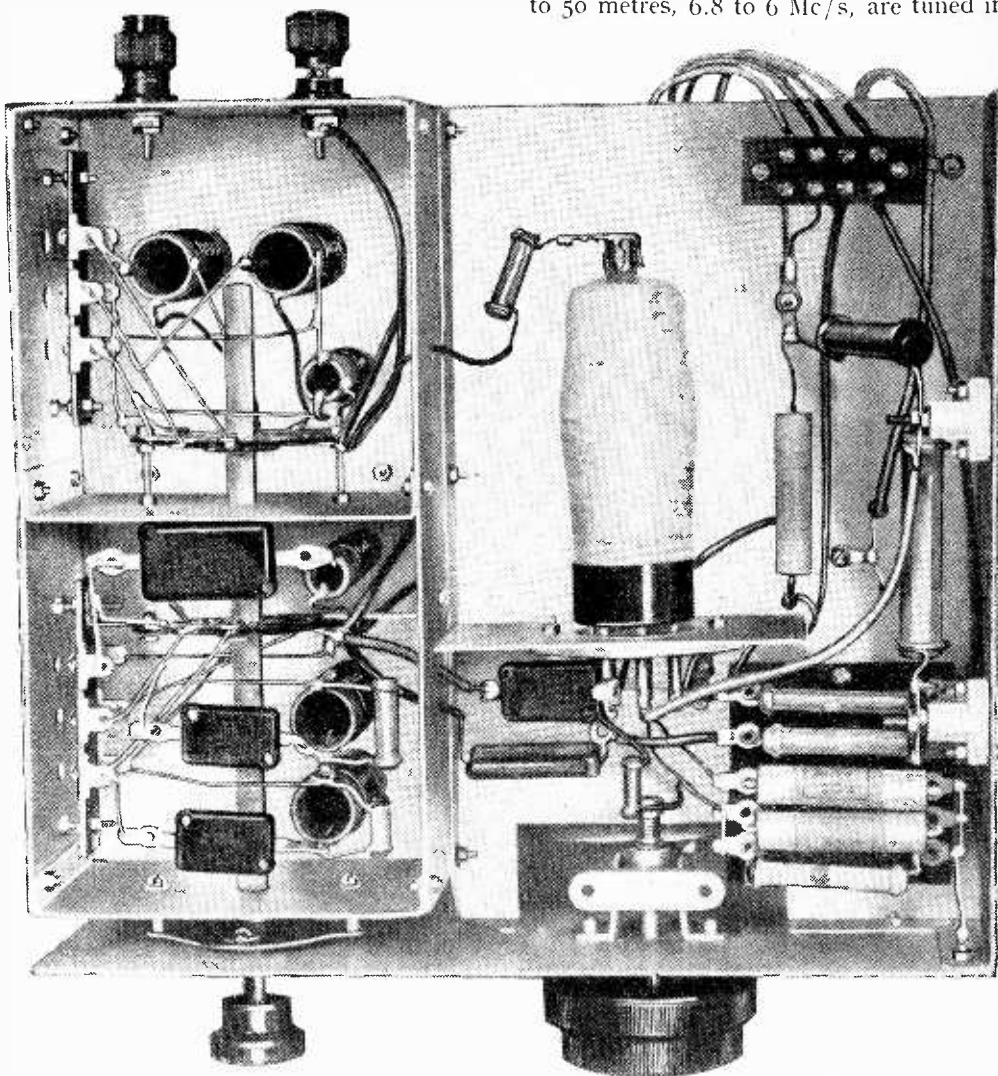

The frequency-changer valve and most of the components are accommodated below the chassis. This view shows also the interior of the coil box.

is screwed up fully and then slackened off about one-quarter of a turn. The signal circuit trimmer C3 will require only a very little capacity.

Initial adjustment of C3 should be made with the pointer at about 15 on the scale, and the condenser is adjusted by its screw to give the best sensitivity, which in the absence of a signal can be judged by the background. An approximate setting only need be found at this stage, since the oscillator trimmer C17 has

on this range between 31 and 48 on the scale. Just outside this band on the lower wavelength, or higher frequency, side will be found the 7 Mc/s amateur band, 41.12 to 42.83 metres, and the centre of this band falls at about 20 on the scale.

Range 2 is required to give a coverage of 22 to 37 metres, 13.65 to 8.12 Mc/s, and is usually the best range for short-wave signals during the afternoon and early evening. It takes in the 11 Mc/s and 9 Mc/s broadcast bands. A good key station is Zeesen DJN on 31.45 metres, 9.54 Mc/s, and adjustments should be made on the oscillator and signal circuit trimmers C16 and C2 respectively to bring in this station at 56.4 on the scale. The

A blue print combining all the constructional drawings is available from the Publishers, Dorset House, Stamford Street, London, S.E.1. Price 1s. 6d. each post free.

AC Short-Wave Converter—

25-metre stations will then be found centre about 24 on the scale.

The most productive range of the three during the daytime will, however, be range one, which tunes from 12.5 to 23 metres, 24 Mc/s to 13 Mc/s. In it are the 13-, 16- and 19-metre broadcast bands and the 21-metre amateur band. American stations can generally be received in daylight in all three of the broadcast bands. W8XK on 13.93 metres, 21.54 Mc/s, should tune in at 17.5; W3XAL 16.87 metres, 12.78 Mc/s, is found at 40.5, and W2XAD, 19.57 metres, 15.33 Mc/s, at 61.4 on the scale. These three make useful key stations for the adjustments, which on this range are made by the trimmers C15 and C1 in the oscillator and signal circuits respectively.

Another useful key point is Zeesen DJE, at times a very strong signal on 16.89 metres, 17.76 Mc/s, just above W3XAL, and it should tune in at 40.6 on the dial.

The amateur band which covers 20.83 to 21.43 metres, 14.395 to 14.005 Mc/s, should be centred at 77 on the scale.

Though precautions have been taken to render the handling of the converter as easy as possible without the elaboration

of band-spread tuning, the frequency coverage of each range is so wide, despite the comparatively small tuning condensers fitted, that those who have not had much previous experience with short-wave sets must be prepared to exercise patience in tuning. Very slow rotation of the dial is essential to avoid passing over stations,

wave signal may cause the receiver to emit a loud howl when the volume control is turned up.

This microphony howl, as it is sometimes called, is due partly to the oscillator drifting and partly to acoustic feed-back to the vanes of the short-wave oscillator condenser.

Though it cannot be entirely eliminated with very selective sets, it can be ameliorated by mounting the converter on sponge rubber and enclosing it in a cabinet. Alternatively standing the cabinet of the converter on a sheet of sponge rubber will usually serve the same purpose.

When it is used with a set having a variable selectivity control howling is rarely encountered if the set is adjusted to have a comparatively wide band response in the IF amplifier. There will be occasions, however, when the IF amplifier will have to be adjusted to a high degree of selectivity to avoid interference from adjacent channels, since the short-wave bands are fairly crowded and there are many powerful stations now in operation.

At some early period during the tests and for preference as soon as the first signal is tuned in, the trimmer on the IF transformer T1 should be adjusted for maximum signal strength. The adjust-

The small power pack is shown on the right and below is the circuit diagram.

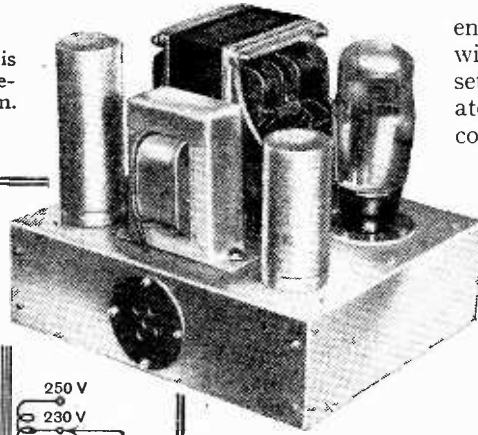
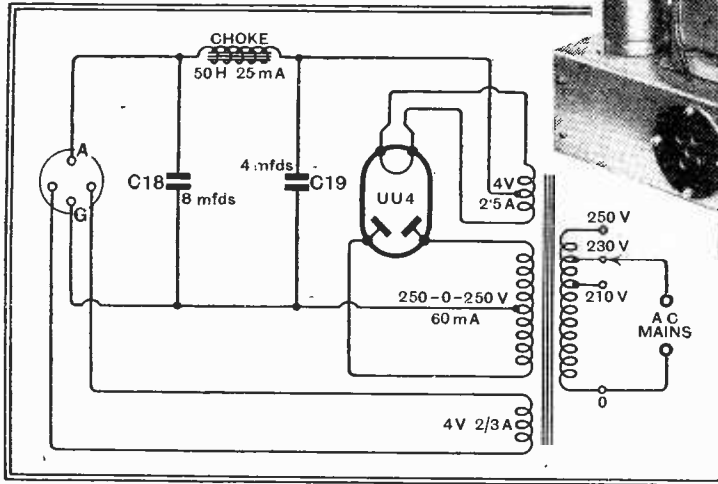

and the slow-motion drive should be used on all occasions other than when changing from one to another of the broadcast bands and the intervening wavelengths are not to be explored.

Owing to the very high selectivity of many broadcast receivers a strong short-

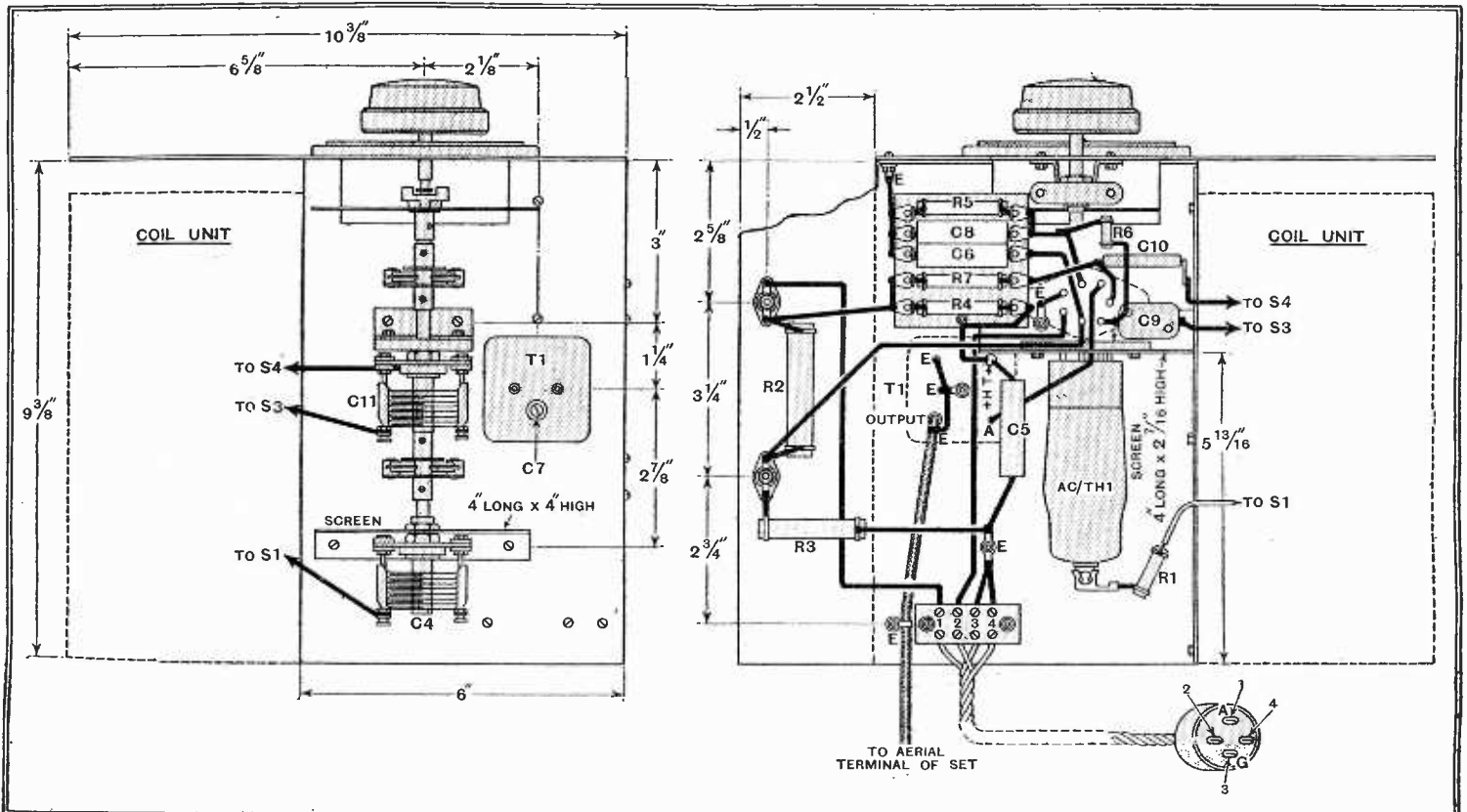

Lay-out of the components for the converter and the wiring plan. Details of the coil box are omitted as these were given in a separate drawing last week.

AC Short-Wave Converter—

ment is not critical, but an optimum setting will be found without any difficulty.

The tuning control on the broadcast set can always be used for fine tuning, but the receiver should not be mistuned much each side of 550 kc/s or the dial readings on the converter for stations that have been identified will not hold good.

When the converter is mounted in a cabinet ventilation holes must be provided. Some of these should be arranged to ventilate the underside of the chassis where the valve and screen-feed potentiometer are housed, and a few large holes in the base below this part of the chassis are desirable.

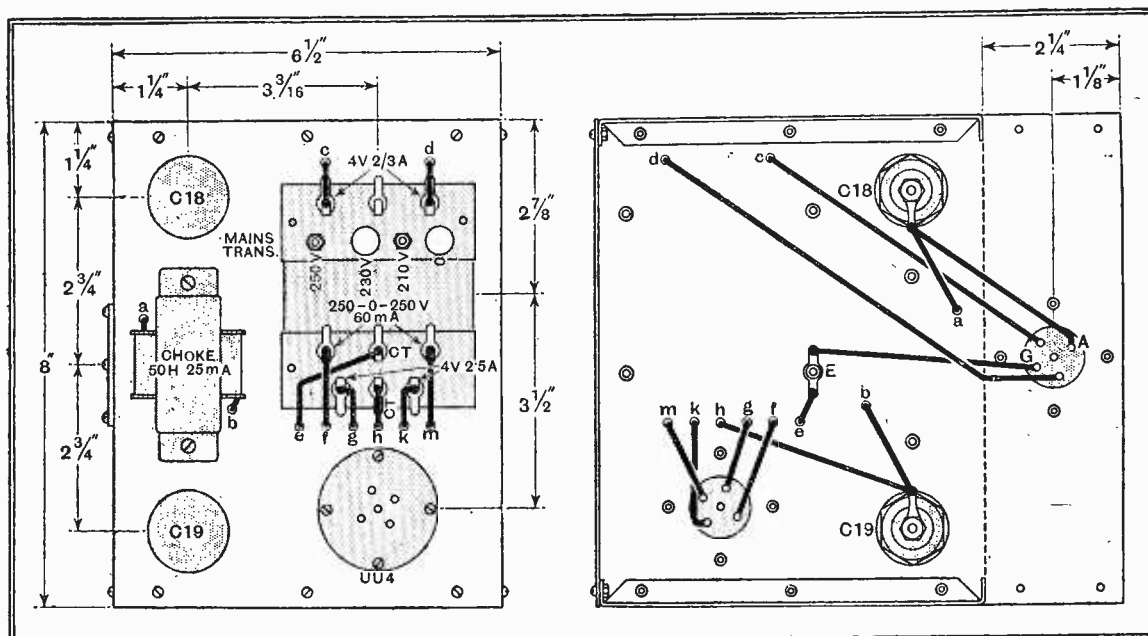

Dimensional drawings, wiring plan and layout of the components for the power pack.

Interference on a Quantitative Basis

The Characteristics and Performance of Apparatus for the Measurement of Radio Interference. (British Standard Specification No. 727-1937). Pp. 28, with 3 diagrams. The British Standards Institution, 28, Victoria Street. Price 2s., by post 2s. 2d.

BY way of excuse for delays in taking strong measures to abate the interference nuisance, it has been urged that quantitative standards for the maximum permissible field strength of interference, etc., must first be formulated and agreed. This view has not met with universal agreement. *The Wireless World*, for example, has urged that the blessed word "reasonable" should be invoked, and has pointed out that legal actions to restrain audible "nuisances" were successfully prosecuted hundreds of years before the introduction of scientific means for measuring sound intensity.

Be this as it may, the introduction of a generally accepted standard for assessing the efficacy of anti-interference devices, and of measuring interference-producing voltages and fields, will be generally welcomed as likely to pave the way for a happier and more equitable state of affairs than that at present existing. British Standard Specification No. 727-1937 has been prepared by committees on which the Post Office, B.B.C., I.E.E., R.M.A., and many other influential bodies were represented, and as it "embodies the relevant agreed recommendations of the C.I.S.P.R. [Comité International Spécial des Perturbations Radiophoniques] as to the nature, essential characteristics and performance of an instrument for the measurement of interference," it should help greatly towards international agreement on matters relating to machine-made interference with broadcast reception.

The specification deals with such technical details as the wave-ranges on which measurements are to be carried out, as well as the audio-frequency range, and lays down rules for such features as input impedance of the measuring equipment and the characteristics of its output indicating device. Methods of carrying out the actual measurements on various types of appliance are given.

The greater part of the booklet is taken

up with a detailed description of portable measuring apparatus complying with the specification; the instrument embodies a superheterodyne unit with a triode-hexode frequency-changer and three 110-kc/s IF stages followed by a diode-triode, of which the triode section serves as a DC amplifier, the indicating meter being connected in its anode circuit. H. F. S.

Television Programmes

Transmission times are from 3-4 and 9-10 daily.

Vision.	Sound
45 Mc/s.	41.5 Mc/s.

FRIDAY, APRIL 16th.

3, Fredrika (mezzo-soprano). 3.10, John Mansbridge will describe and demonstrate portrait painting. 3.20, British Movietonews. 3.30, Theatre Parade. 9, Musical interlude. 9.10, Repetition of 3.10 programme. 9.25, Gaumont-British News. 9.35, Snooker; exhibition of play by Horace Lindrum and Willie Smith. 9.45, Starlight: Steve Geray and Magda Kun.

SATURDAY, APRIL 17th.

3, O.B. of railway locomotives from the Alexandra Palace station. 3.20, Coronation Ware; samples of Coronation pottery, past and present. 3.35, Gaumont-British News. 3.45, Tommy Handley and Company in "The Disorderly Room."

9, Reginald Purdell (comedian). 9.10, Repetition of 3.20 programme. 9.20, British Movietonews. 9.30, "Ad. lib"; a revue by Herbert Farjeon.

MONDAY, APRIL 19th.

3, Margaret Morris Dancers. 3.15, Coronation tree planting. 3.30, "Briny"; a memory and a foretaste of sea-side shows, with Hastings Mann's "After Dinner Company" from the Pier Casino, Shanklin.

9, Repetition of 3 programme. 9.15, British Movietonews. 9.30, Repetition of 3.30 programme.

TUESDAY, APRIL 20th.

3, Demonstration of Fire Walking by Ahmed Hussain in the grounds of Alexandra Palace. 3.25, British Movietonews. 3.35, "April Showers"; comedy in one act. 3.50, Starlight.

9, Personalities—r. 9.10, Repetition of 3.35 programme. 9.25, Gaumont-British News. 9.35, Café Bar: a cabaret show.

WEDNESDAY, APRIL 21st.

3, Victor Hotchkiss and his marionettes. 3.10, Cartoons: Nicolas Bentley. 3.20, Gaumont-British News. 3.30, Forty-Seventh Picture Page.

9, Musical Act. 9.10, Repetition of 3.10 programme. 9.20, British Movietonews. 9.30, Forty-Eighth Picture Page.

THURSDAY, APRIL 22nd.

3, Anona Winn; songs. 3.10, Architecture.—2 3.25, British Movietonews. 3.35, Play.

9, Music Makers: Alfredo Campoli. 9.10, Repetition of 3.10 programme. 9.25, Gaumont-British News. 9.35, Cabaret.

The Radio Industry

THE current issue of the *Bulgin Monthly Bulletin* contains information on newly introduced components (small high-voltage condensers and high-voltage insulators), further information on the Bulgin vibratory HT generator, and an article on automatic grid bias. A scheme has been formulated whereby Bulgin interference-suppressing devices may be purchased on a three-day trial and approval plan.

La Société Française Radio Electrique has sent us an attractively produced booklet describing the recently inaugurated radio-telephonic link between France and the U.S.A.

Film Industries advise us that as a result of the increase in price of material there will be a 10 per cent increase as from May 1st in the prices appearing in current lists.

Philco announces the introduction of two new all-wave superhets for AC mains. Eight valves are used and a coverage of from 150 kc/s to 18.2 Mc/s is provided in four steps.

Duilibier resistances and condensers are now being supplied on cards; the various ranges include capacity and resistances values in greatest demand for replacement and other purposes. Components in cartons will still be supplied.

The Future of Television

WHY A NEW TECHNIQUE OF PRESENTATION MUST BE DEVELOPED

By R. W. HALLOWS

IT was, I believe, G. K. Chesterton who wrote in the early days of broadcasting: "We have invented a wondrous method of talking to the ends of the earth, but seem to have no messages worth the sending." Very much the same might be said of television today: we have achieved a means of sending images through the ether, but at present we don't appear to have many worth-while images to send. In a word, now that we have television after so many years of waiting we don't yet quite know what to do with it.

Something of the kind often happens when important inventions reach fruition, even if their development has been watched eagerly and expectantly. Unless there is an obvious and immediate application to warlike or commercial purposes a considerable amount of time may be required to discover their real scope and to evolve a suitable technique for them.

Again, the ties of old associations are difficult to break. For years the designers of railway passenger vehicles could not forget the coach and the brougham; the motor car was for a long time just a horseless carriage; the wireless receiver of 1922 with its horn loud speaker was distinctly reminiscent of the gramophone of the period, and the broadcast items that it reproduced were largely the kind of "turns" of which wax records were then made; the cinematograph in its early days showed mainly films that were first cousins to the moving and dissolving comic slides of the magic lantern.

AMERICAN PROGRESS. Inside the television studio in the R.C.A. Building in New York, where the N.B.C. are carrying out extensive experimental work.

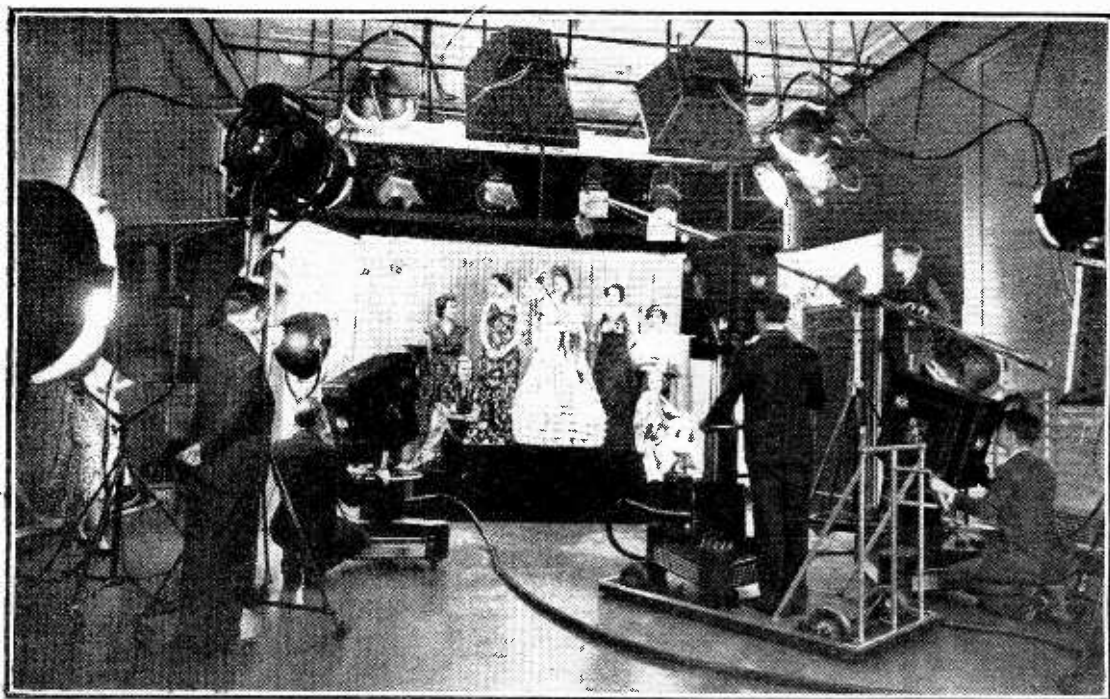

To-day television is finding it difficult to break away from the shackles of talking-film methods. It is, perhaps, rather natural that television transmissions nowadays should be so much on talkie lines. In both cases you have a method whereby moving images can be projected on to a screen whilst their accompanying sounds are reproduced by a loud speaker. But when you come to examine them in detail

it becomes quite clear that moving-picture technique, though much may be learnt from it, is not suitable *en bloc* for television.

If we can determine exactly how the scope of television differs from that of the "talkies" we shall be well on the way to discovering the lines on which the technique of the former can best be planned.

Film sources are almost unlimited: a single programme may take you from the Sahara to Alaska, from Cornwall to the Society Islands. For direct projection television is at present tied down to a radius of about 1,000ft. from the nearest tapping point of a co-axial cable connected to the transmitting station.

On the other hand, television projects its images instantly, whilst events recorded by the cine camera cannot appear on the screen until some time after they have happened.

Scenes involving considerable numbers of people or big areas are suitable for the large screen of the cinematograph, but not

millions of people will pay to see it in the world's picture houses. The television producer has to keep within the limits of a fixed and not very large expenditure. His limitations are even narrower than those of the theatrical producer, who can count on a week's run with the worst of plays.

It would seem that anything like an all-day television programme is entirely out of the question for some time to come. Apart from the matter of expense, there is neither sufficient staff nor sufficient accommodation available for the immense amount of rehearsals that would be needed. But does anyone want more or less continuous "vision" entertainment morning, noon, and night? I don't think so. What I would suggest is: (1) That the "sound" transmitters at the Alexandra Palace¹ and at other high-definition stations as they come into action should give genuine high-fidelity radiation of the local regional programme at all times when there is no television broadcast; (2) that there should be, say, three fixed television hours each day devoted to set programmes; (3) that there should be brief "news flashes" at intervals.

Let us see how these proposals would work out. The adoption of the first would

for the present small one of television.

Films are not made without many "retakes," and before they assume their final form much cutting and editing must be done. No such things are possible in television; there can be only one "take" and no subsequent revision.

Last, but perhaps most important of all, an enormous amount of money may be spent on a single film in the hope that

enable the owner of a television set to use its "sound" portion at all times for obtaining reproduction of the highest quality of the regional programme; he would not feel such reluctance as he may now about spending a good deal of money on apparatus that can be used only for an hour or

¹ Or the B.B.C.'s ultra-short-wave plant at Broadcasting House.

The Future of Television—

two each day. The second and third suggestions, were they put into practice, would provide ample opportunities for using the "vision" side of the receiver.

And what are we to do with the fixed television hours? First, I feel that the films which are shown should not be such as one can see rather better at any picture theatre. The standard news reels come under this head, but we might probably except "trailers" of outstanding films. If there are to be news reels they should be specially made each day; but I would rather see news dealt with mainly by the "flashes," to which I shall come in a moment when we discuss the third suggestion.

Since retakes are impossible, and there are great difficulties about arranging the number of rehearsals that are necessary to ensure clockwork precision, one wonders whether television will not tend to grow up outside the studio rather than in it. Many of the "sound" outside broadcasts, for instance, could be made into excellent fare for viewers if televised either directly or by the indirect film method. So far, no theatre or music-hall has been wired for television transmissions. Could it be arranged that all of the more important ones were available, scenes from plays or turns from variety bills would be most acceptable.

In time, I imagine, not only the theatres and the variety houses, but also sports grounds and buildings such as the Albert Hall, the Queen's Hall, Olympia, Earl's Court, the Agricultural Hall, to mention but a few that come to mind, will be adapted for television transmissions, and then there will be no dearth of programme material.

Some studio work there is bound to be, but I feel that in this matter normal "sound" broadcasting and television will rapidly become closer and closer partners instead of remaining the more or less separate entities that they now are. All important speakers, debaters, solo artists, entertainers, concert parties, and so on, are bound to be televised as a matter of course in the near future, their words or music being also transmitted, just as they are at present, from regional and national stations for the benefit of those who cannot look in.

Such a close partnership is, after all, the natural line of development; it is also the economical line for the evolution of programmes suitable for both sound and vision transmission, or sound alone, means a great saving in expense and the possibility of providing television as a regular thing with material of the highest class, which might otherwise be beyond its means, save on rare occasions.

Lastly, there is the question of news flashes. Here there must be no conflict of interests with the newspapers, which are far too valuable a national asset for us to allow them to suffer by encroachments on their established rights. Nothing of the kind need occur. What I have in mind is that one or more of the mobile television units should be on duty at most

times, the work being twofold. At any time the announcer might break into the ultra-short-wave "sound" programme to tell us to stand by for a brief television transmission of some item of interest. News flashes of this kind, which might be given quite frequently, would serve as *hors d'œuvre* rather than solid fare, and should do anything but injure the newspapers. The second duty of the television vans would be to prepare films, which might well be sent out as a visual accom-

paniment to the "sound" news bulletins.

Well, there are some ideas for the ways in which television may be developed. If they do nothing else, they will at least provide a basis for argument and discussion. There is just one more thing that I should like to add: Whatever else happens, those responsible must not succumb to the temptation (there are signs of it already) to make television programmes too instructional. Entertainment must be their main object all the time.

In Next Week's Issue

Ultra-short-wave Quality Receiver

Three-Valve Straight Set Designed to Work with "The Wireless World" Quality Amplifier

TRANSMISSION on ultra-short wavelengths is generally carried out at higher quality than is feasible on the normal broadcast band, for the lack of congestion in this region makes it possible to transmit the highest modulation frequencies. A very high standard of reproduction thus becomes possible without difficulties from the interference, such as sideband splash and heterodyne whistles, which is all too common on the medium waveband.

At the present time the only regular transmission on the ultra-short waveband is the Alexandra Palace sound accompaniment to television, but it is anticipated that the B.B.C. transmitter on Broadcasting House will commence relaying one of the London programmes ere long. There is no doubt that when this occurs all who are within its range and are suitably equipped will prefer to use it in preference to the medium-wave station on account of the superior quality obtained.

The Ultra-short-wave Quality Receiver is a three-valve straight set which is intended for use with the Push-pull Quality Amplifier, the PA Amplifier, or the amplifier of the Pre-tuned Quality Receiver. A single RF stage is included with a grid detector and a phase-reversing stage. The set is extremely simple to construct and handle, and, although it is not really intended for such purposes, its sensitivity is sufficient to enable reception of American amateur stations on the 10-metre band when conditions are favourable.

LIST OF PARTS.

- 2 Variable condensers, 40 mmfds. "Apex Economy" Webb's Radio 14, Soho St., W.1.
- 1 Variable condenser, 15 mmfds. "Apex Economy" Webb's Radio
- 1 Dial, dual ratio Eddystone 1070
- Condensers:
 - 2 0.01 mfd., mica T.C.C. "M"
 - 1 0.0001 mfd., mica T.C.C. "M"
 - 2 0.0005 mfd., mica T.C.C. "M"
 - 1 50 mfd., 12 volts, electrolytic T.C.C. "FT"
 - 2 8 mfd., 460 volts peak, electrolytic T.C.C. 802

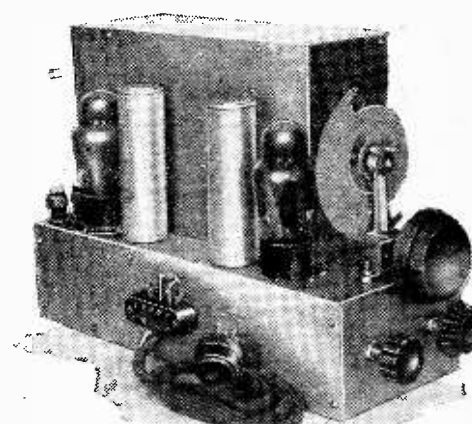

- Resistances:**
- 1 100 ohms, 1/2 watt Dubilier F 1/2
 - 1 500 ohms, 1/2 watt Dubilier F 1/2
 - 1 2,000 ohms, 1/2 watt Dubilier F 1/2
 - 1 10,000 ohms, 1/2 watt Dubilier F 1/2
 - 3 25,000 ohms, 1/2 watt Dubilier F 1/2
 - 1 50,000 ohms, 1/2 watt Dubilier F 1/2
 - 1 75,000 ohms, 1/2 watt Dubilier F 1/2
 - 1 100,000 ohms, 1/2 watt Dubilier F 1/2
 - 1 2 megohms, 1/2 watt Dubilier F 1/2
 - 1 100,000 ohms, 2 watts Dubilier F2

- 1 Potentiometer, 10,000 ohms, wire-wound Haynes Radio
- 1 Trimmer Bulgin SW95
- 2 Coils (constructional details will be given)
- 3 Extension control outfits Eddystone 1008
- 1 Valve holder, 5-pin (without terminals) Clix Chassis Mounting Standard Type VI
- 1 Valve holder, 5-pin (without terminals) Clix Chassis Mounting SW Type V5
- 1 Valve holder, 7-pin (without terminals) Clix Chassis Mounting SW Type V5
- 1 Socket strip Clix "C"
- 2 Terminals, ebonite shrouded, output +, - Belling-Lee "B"
- 1 Group board, 10-way Bulgin C32
- 1 Plug top valve connector Belling-Lee 1175
- 1 Connector, 5-way Bryce
- 1 Cable, 5-way, with twin 70/36 leads and 5-pin plug Goltone

- Chassis:** (Dimensions will be given)
- Miscellaneous:** Peto-Scott
- 2 Lengths Systoflex, 1 oz. No. 18 tinned copper wire, aluminium for brackets, etc. Screws: 48 6BA 1/4 in. R/hd.; 2 4BA 1/4 in. R/hd.; 2 6BA 1/4 in. R/hd., all with nuts and washers.
- Valves:**
- 1 TSP4, metallised Mullard
 - 2 MH4, plain Osram

UNBIASED

A Medical Veto

By

FREE GRID

TO those readers who might be looking forward to the result of my projected bathroom experiments to which I referred last week, I regret that I shall have to be a disappointment, but I have been deterred by my medical adviser, for reasons not unconnected with part of my early life spent out East, from doing what I proposed, and so the experiments are—for the moment, at any rate—off. My medical readers and others who have lived out East will, perhaps, guess the unfortunate reason.

Concerning Radiograms

I AM very pleased to see that a radiogramophone has been introduced which makes use of the sound-on-film principle of recording. Its advantages are obvious, for apart from the fact that a continuous programme of one hour's duration can be enjoyed without changing the record, there is a pleasing absence of bulk and weight in the reels of film. An hour's worth of entertainment can easily be slipped into the jacket pocket whereas I needn't remind you of the impossibility of doing this with the conventional disc-type records. You may argue, of course, that sensible people don't want to shove records in their jacket pockets, but I am merely using this homely analogy to emphasise the fact that with the new system you can store as much entertainment in a small cupboard as would need a couple of pantehnicons in the case of discs.

Were it not for the blessed fact that this new arrangement is obviously unsuited to an ordinary clockwork motor it would merit my very strong condemnation as it would add yet a new terror to riverside life during the summer. Bad as is the dis-



"... their back-water philanderings"

turbing noise of portable gramophones under present conditions, they would be infinitely worse were it not for the fact that the bulk and weight of records prevents river hogs from taking too many of them as an accompaniment to their back-water philanderings.

There are one or two obvious disadvantages, however, such as the fact that if the fancy takes you to listen to something in the middle of the reel you are going to have the very deuce of a time to find it. I know what I am talking about in this matter as I have had the same sort of experience with long amateur ciné films and have eventually found a solution by carefully marking the titles of the various scenes contained in the reel at the points where they commence along its diameter.

To use this method, however, the projector or radiogram must naturally be provided with a quick wind both forwards and backwards, but this is quite easily arranged for. In any case this type of radio-gramophone could, if necessary, be supplied with small reels of individual musical items of the same playing time as ordinary discs. Since a lot of people who buy these new machines will undoubtedly already possess a goodly collection of ordinary discs, it is, I think, a mistake not to have built into the machine a separate turntable and pick-up of the ordinary type, or at least a couple of pick-up terminals for an ordinary playing desk.

Talking of playing desks reminds me of another thing, and that is that it wouldn't be at all a bad idea if special playing desks were made available for use with these film records so that they could be used with our existing sets. Probably there would be a greater sale for these than for complete sets, as the average man who already has a good set naturally feels loth to scrap it for the sake of getting a special type of gramophone, no matter how good the latter may be. The necessary small pre-amplifier and its miniature power-pack could easily be built into the playing desk.

To What Base Uses

I SUPPOSE that most of you, like myself, although not given over entirely to the evils of betting and gambling, indulge in an occasional flutter in the cases of races of world-wide renown such as the Derby and the Grand National. It is a thoroughly bad habit, of course, from a moral point of view, although curiously enough I very often feel better in health as a result of it, since the necessity of existing on extremely short commons for a week or two after it gives the digestive organs a badly needed rest.

This year, however, I am not feeling in my usual good health after my post-Grand National fast, since, owing to a most extraordinary circumstance, I was deprived of it. I had strolled out on the day of the race to see my customary com-

mission agent on the street corner and was just about to hand over my betting slip with the name of a horse written thereon when, without a word of warning, he suddenly took to his heels and bolted.

Now I have frequently had this experience before, but the bolting of the bookie's tout has invariably been preceded by a warning shout from one of his copper-spotters farther along the street. Those of you who study the police court reports as well as the racing news will remember that these unfortunate (?) touts frequently get hauled before the Bench for obstructing the police by warning their lord and master of the approach of Nemesis. Their fines are usually heavy, but since they are paid by their employers out of *our* hard-earned cash it does not affect them much.

On this occasion, however, there was no warning shout of any kind, and instead of



The codfish eye of suspicion.

the customary sight of a couple of breathless policemen coming round the corner at the double to nab their prey there was merely one minion of the law furtively plodding his way along the street and looking at every citizen with the codfish eye of suspicion. I was frankly puzzled and proceeded to make my way to a street in another district where I knew that the firm with which I usually transacted my business had another kerb-side branch.

It so happened that I spotted one of the bookie's touts whom I knew well by sight and almost simultaneously I saw an outsize in policeman. To my amazement the scout took no notice of him whatever and I was just about to shout a warning myself when, far down the street, I saw the rapidly retreating figure of the bookmaker who had, in some mysterious way, received word of the law's approach.

The final result was that I was unable to get "on" this year. I should probably have forgotten all about the incident had I not chanced to mention it to a friend who had recently graduated with first-class honours from the Police College at Hendon. He was at once interested, and set himself to work keeping observation at certain well-known bookmakers' pitches in the suburbs. The result of this was that although lacking any evidence of an offence against the betting laws, he arrested a commission agent and a brace of well-known touts on a charge of loitering with intent to commit a felony, a charge which proved perfectly well founded when the prisoners were searched at the station and a complete ultra-short wave trans-receiving equipment was found.

Current Topics

NEWS OF THE WEEK IN BRIEF REVIEW

Another 100 kW Station

THE Rome station has been making several tests with increased power, and will, it is hoped, soon be transmitting regularly on 100 kW.

News from Poland

WITH a view to increasing the number of listeners, the Polish authorities have decided to raise the power of Warsaw to 150 kW and to build a number of new high-powered stations. In addition, a "People's Receiver" is to be made available. Poland has about 600,000 listeners.

More Power for Graz

COMPLAINTS have been made by the inhabitants of Eastern Austria of poor reception from Vienna owing to the fact that the aerial is directional towards the West. To remedy this, the power of the Graz station, which acts as relay to Vienna, has been raised to 15 kW, and its aerial heightened.

Tunis Station Opened

AN unfortunate technical hitch marred the opening ceremony of the rebuilt Tunis station. When the station was switched on in the presence of the Bey of Tunis and many important officials including the French Resident-General, nothing happened, and it was some time before the engineers could locate the trouble.

International Broadcasting

BETWEEN 1924 and 1929 there were only seventeen instances in which European programmes were relayed by American stations, or vice versa. In 1930, however, the number jumped to 103. Last year it was 678.

New Police-trap Device

THE new R.C.A. car-speed detector, which was recently demonstrated, uses photo-electric cells. The instrument contains two cells a foot apart into which two parallel beams of light shine from a lighting unit on the other side of the road. Immediately the car has broken the second beam its speed is automatically registered by the machine.

The Tower of Stentor

THE leading feature of the great World's Fair to be held in New York in 1939 will be a stone obelisk 700ft. high from which will protrude giant loud speakers enabling announcements to be heard in any part of the grounds. The "stunt" nature of this idea is said to be the cause of its being adopted in place of the more conventional arrangement of having several loud speakers in different parts of the Fair.



THE MAN IN THE STREET is interested in Television. A receiver chassis in a well-known window in Kingsway (London) attracts a crowd.

experiment soon with a duplex system employing two separate wavelengths. The apparatus used embodied a battery double pentode, one of the latter, in the case of the transmitter, acting as an oscillator and the other as a modulator. When receiving, the oscillator functions as a super-regenerative detector, and the modulator as an LF amplifier.

N.B.C. Stations

THE total number of broadcasting stations operated by the National Broadcasting Company of America now amounts to 133, of which fifteen function on short waves.

Car Radio News

CERTAIN car manufacturers in the U.S.A. are insisting that when dealers fit car radio to their products before selling them, only one particular make of set shall be used. This is causing considerable dissatisfaction.

A recent attempt to make car radio illegal in Idaho was heavily defeated in the State Congress.

I.E.E. Lectures

THIS evening (April 16th), Mr. J. B. Kramer will deliver a lecture entitled "The Photocell and Its Application in Industry." This will be followed by a discussion.

Havana Radio Congress

AN important radio meeting is taking place in the Cuban capital, at which Canada, the U.S.A., and all the many republics of Latin America are represented. No questions concerning programme policy are on the agenda, the discussions being confined to technical matters.

Electrification to Popularise Listening

THREE hundred and fifty villages scattered throughout Hungary are to have an electricity supply. The Government has been largely influenced in its decision to carry out this project by the decline in broadcast listening which has taken place in remote country districts owing to battery charging difficulties. During the past year the number of listeners in Hungary has declined by over 24,000.

Communal Receivers

A SCHEME is being prepared by the Egyptian Minister of Education whereby communal wireless receivers will be established in each village for disseminating instructional talks to the peasants. The average villager in the Land of the Nile is far too poor to afford a good radio set of his own. The scheme will cost about £130,000.

Town and Country

ONLY 44 per cent. of the receivers sold in Canadian rural districts last year were of the all-wave type. In urban areas, however, the proportion was 78 per cent. This is said to be partly due to the fact that in the towns AC mains are almost universal, although the conservatism of country dwellers is thought to be the principal cause of it.

Glider Radio

SOME interesting experiments in the use of 5-metre transmitters were recently carried out under the auspices of the Radio Section of the Murphy Radio Sports Club. Successful two-way communication was established between a glider in flight and a ground station using one wavelength and the "switch-over" system. It is hoped to

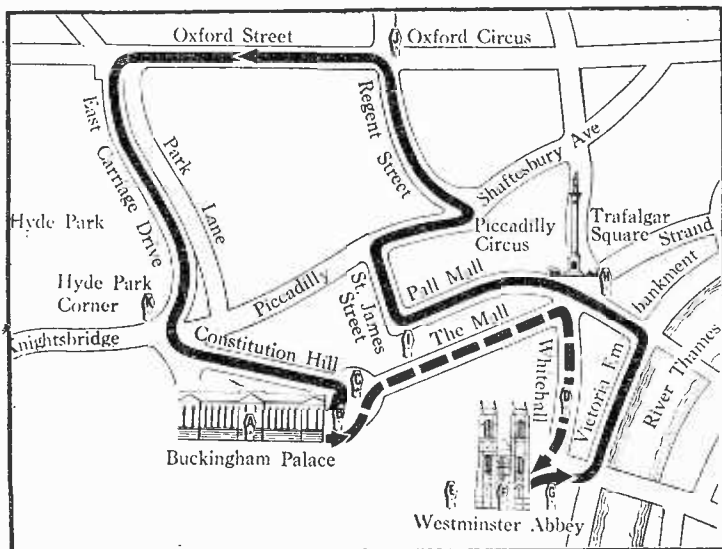

CORONATION PREPARATIONS. This map of the procession route, which has been compiled by the N.B.C. of America, shows lettered microphone positions at which commentators will be stationed. These microphones will, of course, be placed in position by the B.B.C. and will therefore also be used for the B.B.C. broadcasts. According to the N.B.C. details, microphones will be placed as follows: Two inside and four outside Buckingham Palace; two at Constitution Hill and the Mall; two at the Cenotaph; two outside and thirty-three inside Westminster Abbey; two inside the Abbey Annexe; one in Trafalgar Square; one at St. James's Palace; one in Oxford Circus, and one at Hyde Park Corner.

Listeners' Guide for the

All times given in these pages for programmes from Sunday onwards are British Summer Time, which comes into operation at 2 a.m. on April 18th.

BROADCASTS of opera will be a regular feature in the programmes during the coming season at the Royal Opera House, Covent Garden, which opens on Monday. There will be a greater proportion than usual of French and

Lord Snell, the Socialist peer, who was recently re-elected for the fourth successive year as Chairman of the London County Council. His contribution will be made on Wednesday at 9.30 (Nat.).

All the speakers chosen for this series are distinguished men whose views reflect experience and mature thought on the problems common to the peoples of the great British Empire. They will speak of the responsibilities of the

present at this the first important sale of the season. Listeners must not expect a boisterous broadcast, as the auctioneer's voice alone is heard during the sale, while bids are made by the raising of a hand or the nod of a head. Only when records are reached is the calm disturbed.

RATCLIFF HIGHWAY

IN commemoration of what was once one of the most notorious streets in London, a

90 yards, some thirty-five public houses. Profitable sidelines, such as dope-peddling and organised "shanghai-ing," flourished quite openly.

INDOOR BISLEY

THE O.B. department is arranging a novel broadcast of what is popularly called "The Indoor Bisley." This is a small-bore rifle championship to be shot at Alexandra Palace on Saturday. The teams entered consist of three marksmen. Six pottery discs about the size of a halfpenny form the target at about 40 yards range. The first team to break the six discs wins the heat, and the final is shot for in the same manner. The teams open rapid fire at a blast on a whistle. Captain E. H. Robinson in his commentary at 5.45 (Nat.) will cover the quarter finals, the semi-finals, and the finals.

THREE WOMEN

THREE separate sketches have been arranged to form one programme by M. H. Allen, each sketch being an adaptation by her of a short story by Katherine Mansfield. They are three studies of women, and the characterisation provides clear-cut and



Italian opera, and a feature of the season will be a visit of the entire Opéra and Opéra Comique Companies from Paris. On the opening night Verdi's "Othello" will be broadcast in its entirety, Acts I and II being relayed Regionally at 8 and 8.50 respectively, and Acts III and IV Nationally at 9.50 and 10.40. On Wednesday, Regional listeners will be able to tune in to the second act of Donizetti's "Don Pasquale" at 9.20. Each broadcast from the Royal Opera House will be preceded by a five-minute introduction.

EMPIRE PROBLEMS

An important new series of ten talks, entitled "The Responsibilities of Empire," will be opened this week by the Prime Minister. He will be heard Nationally at 9.20 tonight (Friday). The second speaker in the series will be

Empire both to itself and to the world at large.

UNDER THE HAMMER

A SALE at Sotheby's provides an unusual Regional broadcast on Monday, when art treasures removed from 148, Piccadilly, including valuable Dutch paintings, will be auctioned. These treasures were the property of the late Lord Rothschild, and are now being sold by Mr. Victor Rothschild, who is giving up the nineteenth-century London mansion.

It is hoped that the Dutch landscapes included in the collection will come under the hammer between 1 and 1.45, and the B.B.C. is arranging to have an expert on the spot at this time. He will have the assistance of Messrs. Sotheby's secretary to point out the famous dealers of world repute who will be

IN THE FOYER of the Royal Opera House, Covent Garden, on the opening night of the 1935 Jubilee season. The Coronation season, which opens on Monday with "Othello," will provide many opera broadcasts.

programme, "The Ratcliff Highway," to be broadcast tonight (Friday) at 8.15 (Nat.), has been devised by Thomas Burke. He is author of many books dealing with life in the poorer districts of the Metropolis, and is well known for his "Limehouse Nights" and "The London Spy." The famous, or infamous, highway is now prosaically known as St. George Street, Stepney, and is soon to undergo demolition. In its heyday the street saw scenes of noisy gaiety and drunken debauchery. Back in the 'sixties, when a ship arrived in London river the seamen made automatically for Ratcliff Highway, which contained, in a distance of about

arresting contrasts. The first, "Ma Parker," is concerned with a charwoman who, whilst washing up, soliloquises about her squalid existence and unhappy domestic affairs. Next comes "Pictures," the story of Miss Moss, an ageing and unsuccessful soprano who tries to break into the film world. Finally, "The Lady's Maid," a brilliantly revealing monologue.

These poignant life stories in miniature were first heard separately in the "Miscellany" programmes broadcast in 1932-33. The principal parts were then taken by Margaret Yarde, Vivienne Chatterton, and Gladys Young respectively, who will repeat their

Week

memorable performances on Sunday at 7.15 (Nat.).

MUSIC

PAUL WITTGENSTEIN, the one-armed pianist, will play the Ravel Pianoforte Concerto for left hand alone at 7.50 (Reg.) to-night (Friday). This Concerto received its first performance in England at a Promenade Concert in 1932. It is characteristic of the scintillating and brilliant piano style of Ravel, who composed it specially for this pianist. Wittgenstein has made a speciality of arranging music for pianoforte for the left hand alone, and many leading composers have written works specially for him. A feature of this programme, which is to be conducted by Clarence Raybould, will be a performance of Glazounov's ballet, "The Seasons," which includes the famous Bacchanale immortalised by Pavlova and Mordkin in the early days of Russian ballet.

The last Sunday orchestral concert of the season will take place this week at 6.30 (Reg.). Sir Adrian Boult will conduct, and the programme, an all-British one, will consist of Elgar's Violin Concerto, with Jean Pougnet as soloist, John Ireland's "London" Overture, and Holst's ballet music, "The Perfect Fool."

SECOND HOUSE

THE first of the new Saturday night Variety programmes "Second House" will be presented by Archie Campbell this week in the National programme at 8. Carl Brisson, who shortly undertakes a tour of provincial music halls, will be heard in several specially-written new numbers. In the same programme listeners will hear Kimberley and Page, Walsh and Barker, Fred Gwyn, Gypsy Nina, and Brookins and Van. Davy Burnaby will be host, and Charles Shadwell will conduct the Variety Orchestra.

This will be the first of the Variety programmes to alternate with "Music Hall,"

Details of this week's Television programmes will be found on p. 369

Outstanding Broadcasts at Home and Abroad

which, during the summer, becomes a fortnightly show.

MUSIC FROM THE MOVIES

LOUIS LEVY and his Symphony are giving their next broadcast in the present "Music from the Movies" series on Wednesday at 7.10 (Nat.). Louis Levy made a great name for himself while conducting various cinema orchestras, and eventually he was appointed studio musical director for Gaumont-British productions. During 1936 he introduced to broadcasting "Louis Levy and his Symphony" in this now popular series.

OPERA

LISTENERS who are interested in modern opera will be glad of the opportunity of hearing "Blue Beard's Castle," a one-act opera by the famous Hungarian modernist composer, Béla Bartók, which will be broadcast from the Royal Hungarian Opera House, Budapest, on Saturday, and relayed Regionally at 8. This is a work of grim and enigmatic character, full of atmosphere and dramatic interest.

Produced in Berlin in 1816, "Undine" is one of the dozen or so operas of that most eccentric

WALSH AND BARKER, the American duettists, who will be heard in "Second House," the variety show which takes the place of the usual Saturday "Music Hall."

and versatile of composers and *littérateurs*, E. T. A. Hoffmann, of whom Carlyle said that he wasted on wild living gifts which might have seasoned the nectar of the gods. Recordings of this opera will be broadcast from Cologne at 9.30 to-night (Friday).

Saturday's opera performance from Milan at 8 is "Liola," the work of a much-appreciated contemporary Italian composer, Mulè, the Director of Palermo Conservatoire. He has written some half a dozen operas, as well as incidental music to the Greek

tragedies produced at the Greek Theatre, Syracuse.

Excerpts from the simple pastoral opera, "Le Devin du Village" (The Village Soothsayer), comes from Luxembourg at 9 on Tuesday. Both the words and music of this opera are the work of the philosophical writer, Jean Jacques Rousseau. It was produced at Fontainebleau in 1752, after which followed four hundred performances at the Opéra, Paris.

THE MARSEILLAISE

FROM Brussels II on Tuesday at 8 comes a programme entitled "The Anniversary of the Marseillaise." The French revolutionary hymn was first heard on April 25th, 1792. The programme will include many works which embrace the French National Anthem, among them being Tchaikovsky's 1812 Overture.

CATHEDRAL CONCERT

A FESTIVAL of Church Music is being held in Norway, the crowning event of which is a representative concert in the ancient cathedral of Trond-



heim. The programme, which will be radiated by the Norwegian stations on Tuesday at 8.30, consists of works by contemporary Norwegian composers.

ENGINEERS' ORCHESTRA

ON Saturday at 7.55, the Finnish long-wave station, Lahti, will be radiating a concert given by the Polyteknikernas Orchester. The members of this orchestra, which enjoys immense popularity, are drawn from the engineering staff of the Finnish Polytechnic. THE AUDITOR.

HIGHLIGHTS OF THE WEEK

FRIDAY, APRIL 16th.

Nat., 7.15, The Wireless Puppets. 8.15, Ratcliff Highway 9.20, The Prime Minister. Reg., 6, Worthing Municipal Orchestra. 9, Star gazing; Edith Day. Abroad. Kalundborg, 9, Opera and operetta music.

SATURDAY, APRIL 17th.

Nat., 7.30, B.B.C. Presents the A.B.C.—B. 8, Second House; a radio variety. 9.35, More Macabre: Uncanny stories. Reg., 6, The Wireless Puppets. 8, Relay from the Royal Hungarian Opera House, Budapest. 9, Peter Yorke and his Orchestra. Abroad. Leipzig, 7, "Elektra"; one-act opera (Richard Strauss).

SUNDAY, APRIL 18th.

Nat., 6.15, I Knew a Man. 7.15, "Three Women." 9.5, "Ghosts of London." Reg., 5, The Richard Crean Orchestra. Sunday Orchestral Concert. 9.5, Recital for two pianos; Heinz and Robert Scholz. Abroad. Frankfurt, 8, Ga'a Concert of scenes from opera.

MONDAY, APRIL 19th.

Nat., 7, "Monday at Seven." 8, Talk: Towards National Health —2. 9.50 and 10.40, Acts III and IV of "Othello," from Covent Garden. Reg., 6.40, Anona Winn and her Winners. 8 and 8.50, Acts I and II of "Othello." Hermann Löhr's music—Reginald Foort at the Theatre organ. Abroad. Lille PTT, 8.30, Symphony concert from Paris.

TUESDAY, APRIL 20th.

Nat., 6.25, The Empire Orchestra. 8, "The Second Round" (Sapper). Reg., 6, The B.B.C. Military Band and Arthur Cranmer. Recital of Syncopated Music, by Ruby Duncan. 9, "The Quaker Girl." Abroad. Breslau, 8.10, Spanish Folk Songs.

WEDNESDAY, APRIL 21st.

Nat., 7.10, Music from the Movies. 9.30, Lord Snell. 9.45, The Ceremony of the Keys. Reg., 6, "The Second Round" (Sapper). 7.45, Variety from the Palace Theatre, Plymouth. Act II of Don Pasquale from Covent Garden. Abroad. Berlin, 9, Hans Pfitzner Concert, composer conducting.

THURSDAY, APRIL 22nd.

Nat., 6.40, Eddie Carroll and his music. 7.40, "The Quaker Girl." Talk—"Words Fail Me." Reg., 7.30, "Aerbut and Gaertic," Birmingham dialect sketch. 7.40, Midland Parliament—Modern Advertising and Industry. 9.5, Jack Payne and his band. Abroad. Rome, 9, "Lucia di Lammermoor" (Donizetti) from the Royal Opera.

The Television Receiver

VII.—THE SIGNAL-NOISE RATIO AND SUPERHETERODYNE

SO far little has been said about the relative advantages of the straight set and the superheterodyne. It has been pointed out that the latter is preferable from the points of view of obtaining high gain with stability and of checking the design by measurement, for the higher the frequency at which amplification is obtained the more difficult it is to avoid instability and to make accurate measurements. While these points are in favour of the superheterodyne, they are not alone sufficient to make us choose it in preference to the straight set, for they are by no means insuperable and they are actually the only drawbacks to the straight set.

Examination of the question in detail may show the superheterodyne to have more serious failings, and if this should happen to be the case we should naturally choose the straight set. In this connection we shall do well to bear in mind that the data on intervalve couplings given in earlier articles in this series applies with equal force to both types of receiver. The only exception is the coupling with series resistance described in Part IV, but this is not of much use even in superheterodynes unless the intermediate frequency is below some 5.0 Mc/s.

INTERFERENCE PROBLEMS

THE problems of signal-noise ratio and interference are treated in this article and it is shown that the superheterodyne needs careful design if it is to be as good as the straight set in the matter of background. The straight set also has the advantage of being free from certain special forms of interference.

By W. T. COCKING

agitation in the conductor of the first tuned circuit is likely to be about $8 \mu\text{V}$. on the grid of the first valve. The valve noise cannot be so accurately calculated, but for the same band-width and for a valve having $g=6.0 \text{ mA/V}$. and a current of 20 mA., the equivalent noise on the grid is likely to be about $26 \mu\text{V}$. The total voltage is thus $\sqrt{8^2 + 26^2} = 27.2 \mu\text{V}$. We can, therefore, say that the circuit noise will be

straight set in the matter of the signal-noise ratio, therefore, the frequency-changer must be preceded by an RF amplifier of sufficient gain for the ratio to be determined by the first amplifier valve. If we call the RF gain A , and the noise voltage on the amplifier grid V_1 , then the noise applied to the frequency-changer is AV_1 . With this must be combined the frequency-changer noise V_2 , and the total noise will be $V_T = \sqrt{V_2^2 + A^2V_1^2}$; inserting the values given above, $V_T = \sqrt{13,900 + 676 A^2}$. We can say that the frequency-changer noise will be negligible if it increases the total noise by 5 per cent. only, or $V_T = 1.05V_1A$. Inserting values, we find that $A = 14.2$. Therefore, the RF amplifier should give a gain of not less than 14 times if the optimum signal-noise ratio is to be secured.

A gain of this order is rather high for a single stage if the requisite band-width is to be maintained. As long as the RF stage gain exceeds about 4.5 times, however, its use will improve the signal-noise ratio, but will not be equal to the straight set unless it reaches 14 times. Actually, a superheterodyne having an RF gain of 14.2 will have the same signal-noise ratio as a straight set of equal sensitivity and with a stage gain of 3.3 times; the latter figure can easily be exceeded.

It is somewhat difficult to determine the lowest signal-noise ratio tolerable, but it is probably about 30-1. Assuming this figure, the weakest signal which will give us a tolerable picture with the best receiver is $30 \times 26 = 780 \mu\text{V}$., and with a superheterodyne having no RF stage about $3,500 \mu\text{V}$. These figures agree well with practical experience.

Maximum Useable Gain

Confining our future remarks to the case of the straight set or the superheterodyne with an RF amplifier, we can calculate the maximum gain necessary to provide full output on the minimum tolerable input of $780 \mu\text{V}$. About 30 volts p-p output is needed, and since the detector efficiency factor of input (RMS volts)/output (p-p volts) is generally about unity, the gain is $30/0.00078 = 38,500$ times. To be on the safe side, we should allow a gain of 40,000-50,000 times. On this question of signal-noise ratio there is nothing to choose between the straight set and the superheterodyne, provided that the latter is properly designed.

An experimental superheterodyne incorporating one RF stage, triode-hexode FC, five IF valves, diode detector and sync separator.

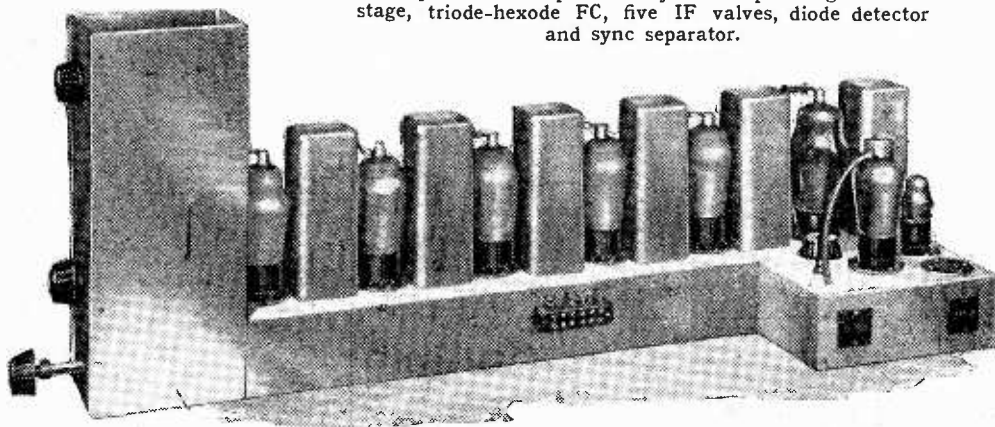

There is first of all the question of the signal-noise ratio. It may seem rather absurd to speak of noise in the case of television reception, but the meaning of the term is well understood, and it is difficult to find a better one to describe the voltage fluctuations in tuned circuits and valves which can cause a background of hiss in sound reception and a dirty background in vision reception.

If we assume a band-width of 4.0 Mc/s and a tuned circuit impedance of 1,000 ohms, the noise voltage due to thermal

negligible in comparison with the valve noise, and this is a normal result in short-wave receivers owing to the low impedance of the circuits.

Now in the case of a frequency-changer the current consumption is lower, some 4.7 mA. only, but the conversion conductance is also lower, about 0.64 mA/V. The equivalent noise voltage on the grid is thus some $118 \mu\text{V}$. A frequency-changer consequently introduces about 4.5 times as much noise as an amplifier. If the superheterodyne is not to be inferior to the

The Television Receiver—

Let us now consider the matter of those special forms of interference to which the superheterodyne only is subject. These follow the ordinary laws to which we are accustomed in sound receivers, but the matter is somewhat complicated by the enormous band-width of the vision amplifier. In what follows it will be assumed that the band-width is 4.0 Mc/s.

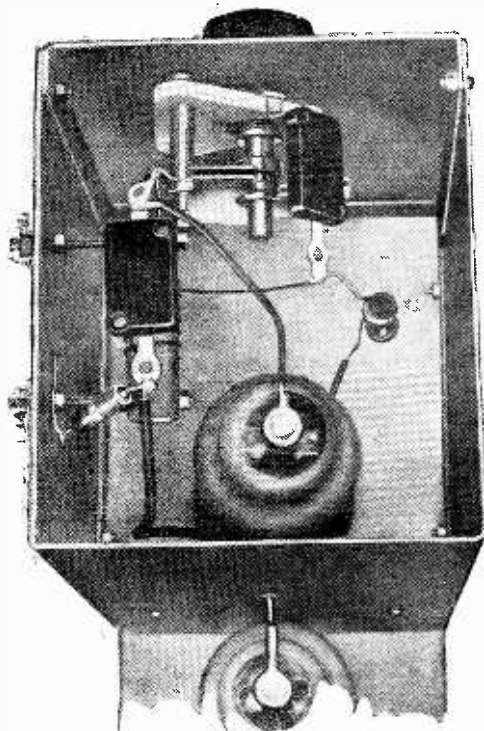

The RF stage can be seen in the screening box with the frequency-changer just outside.

Second-channel interference is the type which first comes to mind. If the oscillator is set at a frequency higher than the signal, such interference can only come from stations operating with frequencies equal to that of the wanted signal plus twice the intermediate frequency plus or minus one-half the band-width of the amplifier. If the intermediate frequency is 10.0 Mc/s, only stations between 63 Mc/s and 67 Mc/s can cause interference. There are probably few or no stations in this band, so that second-channel interference is unlikely to be important, and in practice it is not.

The next possibility of trouble occurs when the frequency difference between two stations of equal strength lies within the band transmitted by the IF amplifier. The only stations which can cause this trouble are the sound and vision transmitters, and their frequency difference is 3.5 Mc/s. To avoid the possibility of interference of this nature, the intermediate frequency should not lie between 1.5 Mc/s and 5.5 Mc/s.

The second harmonic of the beat between the stations is 7.0 Mc/s, and if present at any appreciable intensity would prohibit the use of an intermediate frequency between 5.0 Mc/s and 9.0 Mc/s. The third harmonic is 10.5 Mc/s, and would prohibit frequencies between 8.5 Mc/s and 12.5 Mc/s.

In practice this form of interference is by no means serious. It is probably wise to avoid the use of a frequency near the fundamental difference frequency, but it seems possible to ignore the possibility of interference through the harmonics. Nevertheless, if frequencies of this order are chosen, it is wise to make the midband frequency of the IF amplifier equal to the mid-frequency between two harmonics. In this way any interference will be of high frequency and will be less noticeable. One would choose, therefore, intermediate frequencies of $(3.5 + 7.0)/2 = 5.25$ Mc/s. or, better, $(7.0 + 10.5)/2 = 8.75$ Mc/s.

IF Harmonic Interference

The next type of interference to consider is that produced in the receiver by the feed-back of harmonics of the IF output to the input. If the intermediate frequency is f_i and the band-width $2n$, the output frequencies are $m(f_i \pm n)$ where m is the order of the harmonic. Suppose we make $f_i = 8.75$ Mc/s. and $n = 2.0$ Mc/s, the output frequencies are for the fundamental ($m = 1$) 6.75–10.75 Mc/s, for the second harmonic 13.5–21.5 Mc/s, for the third harmonic 20.25–32.25 Mc/s, for the fourth harmonic 27–43 Mc/s, for the fifth harmonic 33.75–53.75 Mc/s, for the sixth 40.5–64.5 Mc/s, for the seventh 47.25–75.25 Mc/s. Both the fifth and sixth harmonics will cause interference if the feed-back is sufficient.

It is possible to avoid this type of interference by choosing an intermediate frequency such that the signal frequency lies between the first and second or second and third harmonic bands of frequencies. This means a lower limit to the intermediate frequency of about 20.0 Mc/s, however, and if one has to use such a frequency there would seem little advantage over the straight set.

frequencies ranging from 2.5 Mc/s to 10.0 Mc/s, and in all the same interference problems existed to a greater or lesser degree. The results generally found are that as the oscillator tuning is varied so that the intermediate frequency passes through the range of frequencies with which the amplifier will deal, points of interference alternating with points of clear reception are found. The term clear reception is relative, for in some cases there is no point at which complete freedom from interference can be obtained. The interference at the worst points, of which there are usually two or three, takes the form of mottled background to the picture which is not unlike watered silk in appearance. At the comparatively clear points interference is more often in the form of parallel dark lines across the picture. Their number and width, and the angle which they make with the vertical, are dependent upon the precise frequencies involved and change with the tuning.

It is generally possible to find one tuning point at which interference is negligible, but, unfortunately, this is not always the best tuning point for maximum efficiency nor for the best picture. It sometimes happens that at an interference-free point there is severe phase-distortion, with the result that the picture appears in relief.

It is, of course, quite possible to prevent this interference from occurring by preventing the feed-back. This is not as easy as it sounds, however, for an extraordinarily high degree of circuit isolation is necessary. Actually, more screening is needed between the input and output circuits to prevent harmonic interference in a superheterodyne than to avoid instability in a straight set. It will thus be seen that one of the two disadvantages of the straight set, the need for careful screening, is also present in the superheterodyne.

If a television receiver had to be capable of receiving a number of stations like a

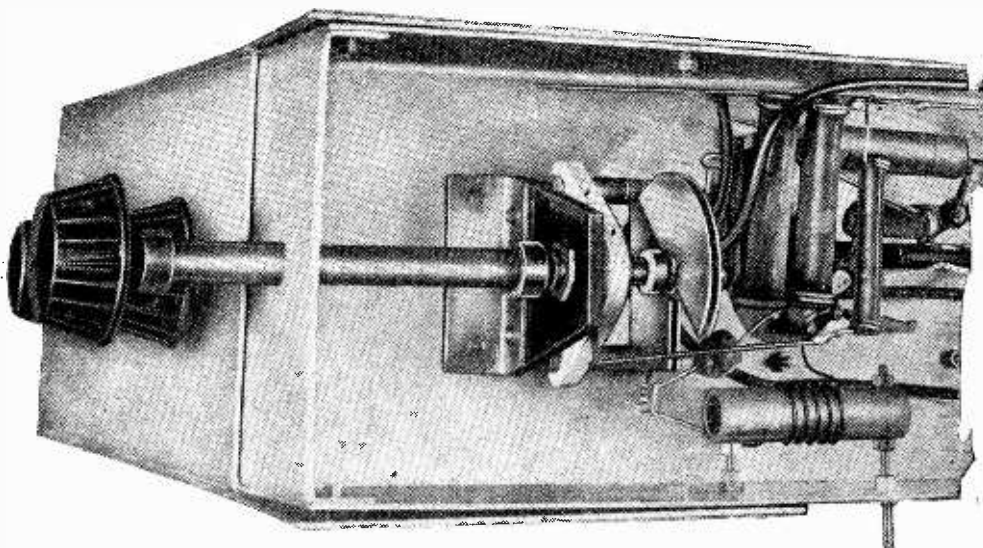

An under view of the chassis showing the oscillator components.

In the writer's experience these forms of interference are by no means theoretical possibilities, but occur in practice to a serious degree. He has used amplifiers at fre-

broadcast set, we should probably be forced to use the superheterodyne on account of the large number of tuned circuits which would otherwise have to be

The Television Receiver—

ganged. We have only a single station, however, so that the straight set can be just as much pre-tuned as an IF amplifier. When we also take into account the fact that it is easier to obtain the optimum signal-noise ratio than in a superheterodyne, it is clear that the straight set is likely to be the more satisfactory of the two. This is especially the case when initial adjustments have to be made with a test oscillator of doubtful accuracy or even on the signals themselves, for the precise adjustment of circuits to dodge some of the interference points is then much more difficult.

Straight Set v. Superheterodyne

After considerable experience with the superheterodyne, the writer has been driven to the opinion that for television reception the straight set is simpler and that for a given amount of apparatus and limited skill of adjustment it gives a better performance. This statement carries greater weight when it is remembered that he commenced work on television receivers with a bias in favour of the superhet.

In the earlier articles in this series particular stress has been laid upon this type of receiver for the reason that most people will feel as the writer did at first that the difficulties of the straight set are too great. By discussing the questions fully in this way, a better understanding of the characteristics of each system is obtained, and most of the data is directly applicable to the straight set.

Contrast Expansion

By

Further Notes on the Simple Lamp Method

GERALD SAYERS

AS pointed out in *The Wireless World* of December 18th, 1936, one of the difficulties of utilising the simple lamp method of volume expansion is that of the inefficiency of a filament which most of the time is not working anywhere near its rated wattage. If the lamp or lamps can be arranged to remain at a good glowing temperature the degree of control will approximate more closely to the desirable square law. Obviously the way is to superpose a constant direct current; in the simplest case, as illustrated, a cell or

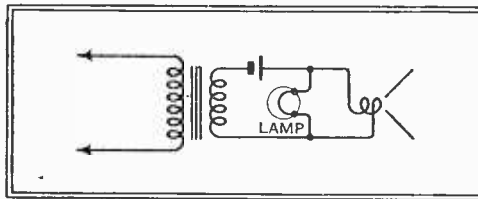

Showing the addition of a cell for supplying "polarising" current to a control lamp.

battery can be inserted to achieve this. An accumulator is not recommended for initial experiments as the available current might cause damage in case of accident.

Usually the normal current is insufficient to hold the speech coil seriously out of alignment, but in any case a trial reversal of polarity might secure the better result. In a final arrangement it may be

possible to balance out direct current through the speaker, and any bridge circuit containing lamps or resistances can be developed on similar lines. Alternatively with a mains-supplied amplifier demanding a relatively large current—and such an amplifier is necessary for successful contrast expansion—the insertion of a potentiometer in the negative lead may supply the current for lighting the lamps and thus the adjustment for optimum conditions may be easily effected; such an expedient makes the selection of suitable lamps considerably easier because the no-load resistance can be set to the desired value, and it would seem that less signal power is wasted than in continually warming up a cold filament. It is safe to say that most lamps will stand transient values up to twice their rated wattages.

Contrast expansion can most certainly have the subjective effect of reducing background noise, although at present probably at the sacrifice of some low-level sounds. When operated at the output end, as in a lamp arrangement, the set noise also can be subdued, and this advantage offsets to some extent the large power wastage. With true contrast compression low-level signals should be brought up at the transmitter well above the total noise level, thus allowing attenuation to their relative values without loss.

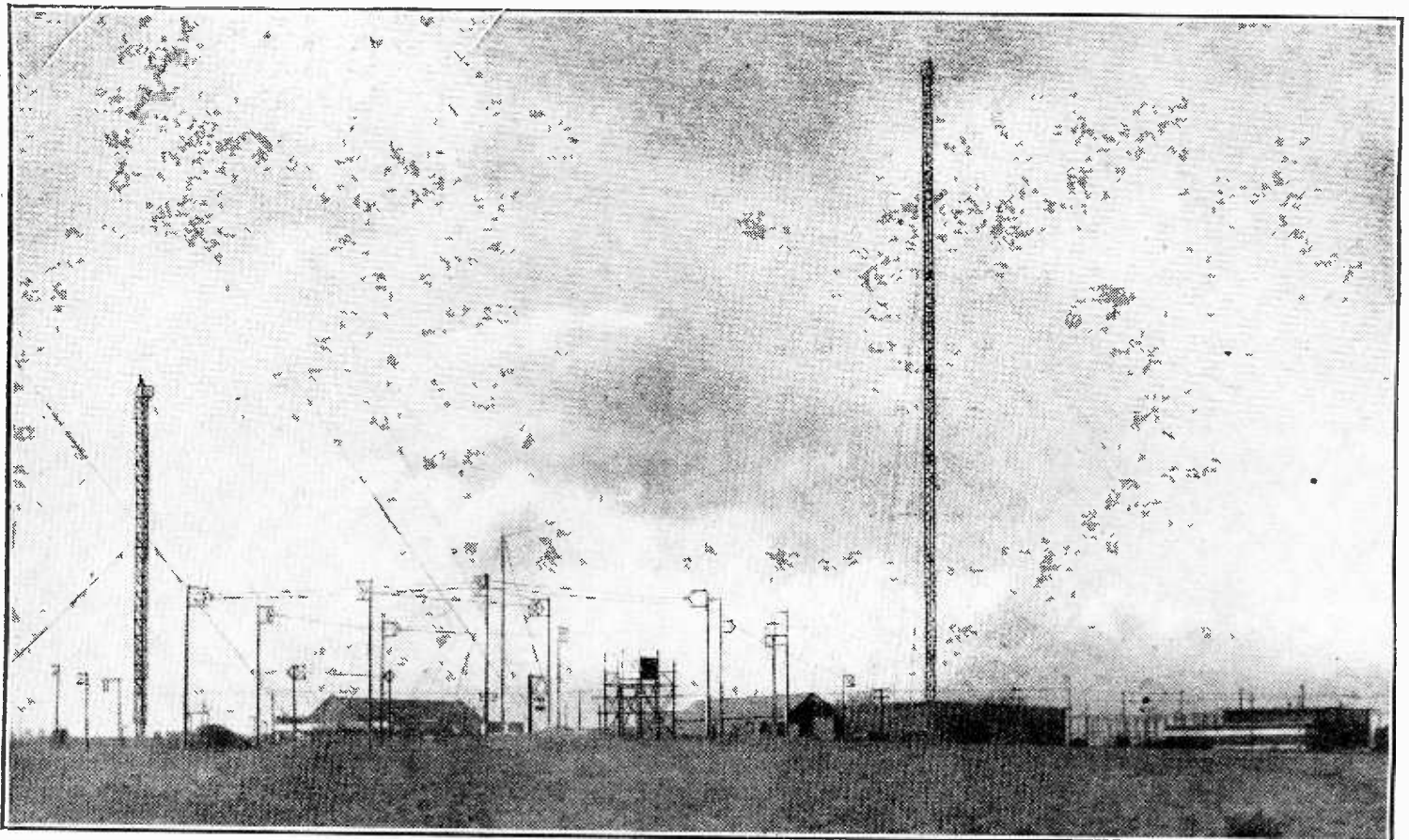

EMPIRE BROADCASTING. A *Wireless World* photograph of part of the site on which stand the new B.B.C. Empire transmitters. Two of the new 50-kW plants are already testing, and it is hoped that these two will be in use by the time of the Coronation. There will, however, be no official opening as time does not permit, but the transmitters will be put into regular service when tests are completed.

Broadcast Brevities

The New Empire Station

SIR NOEL ASHBRIDGE, Chief Engineer of the B.B.C., displayed a tinge of justifiable pride at his Press conference last week when he drew aside the veil which has enveloped the Empire broadcasting station during the past few months.

Work on Europe's most powerful group of short-wave transmitters is now nearing completion, though progress has been slow because entirely new apparatus has had to be constructed to cope with the designs of the B.B.C. Research Department in co-operation with the Marconi Company and Standard Telephones and Cables.

Thirteen Masts

The original Daventry site now accommodates three transmitters of 50 kilowatts each, and there is provision for another; in addition, the old 10-kilowatt plant is being maintained. When the station is ready it will look like a miniature Rugby, for there will be thirteen masts in all. The four old masts remain *in situ*; the nine newcomers will vary in height from 80ft. to 325ft.

Actually, there will be 23 aerial systems capable of transmitting in 12 different directions; most of these will have reflector systems. It will be possible to connect any aerial to any transmitter, and there will be six miles of feeder wire.

Seventy-five Kilowatts?

Thus Daventry resumes its status as a "world beater" which it forfeited when Germany entered the short-wave field. Zeesen employs 40-kilowatt transmitters; Daventry, although rated at 50 kilowatts, is expected to reach 75 or even more, though this may not be achieved for several months.

Yardstick of Reception

Sir Noel demonstrated an interesting gramophone record illustrating the B.B.C.'s standards of reception. Signals from prominent short-wave stations all over the world had been classified according to strength and clarity, but the difficulty had been to give a clear idea of the relative standards to the picked observers in the Empire. Someone hit upon the happy idea of setting out representative examples on this gramophone record, which has been sent to nearly 100 reliable listeners.

For the last three years special log charts have been sent to in-

NEWS FROM PORTLAND PLACE

terested listeners, and since this service was instituted more than 20,000 completed logs have been returned to the B.B.C.

Foreign Languages Soon?

It is hoped to have practically the whole of the Empire station in working order in time for the Coronation. For the first few months, at any rate, only the English language will be used, though the B.B.C., in consultation with the Foreign Office, is now seriously considering whether a polyglot service would make the station of more vital importance to the interests of the Empire.

The B.B.C. in the Abbey

ALTHOUGH the orchestra for the Coronation Service in the Abbey numbers only 59, no fewer than 31 of these will be B.B.C. players, among them

chestra and the Military Band.

The Coronation Orchestra will spend the whole of Sunday, May 2, rehearsing at the Maida Vale studios, making history as the first orchestra to graduate from a former skating rink to Westminster Abbey.

Coronation Commentators

COMMENTARIES on the Coronation procession and on the general scenes are to be broadcast by Harman Grisewood (precincts of Buckingham Palace), John Snagge (Green Park, overlooking Buckingham Palace), Harold Abrahams (Whitehall, near the Cenotaph), George Blake (outside Middlesex Guildhall, facing Westminster Abbey), Michael Standing (in the Abbey annexe), and Howard Marshall (in the Triforium). During the Service the B.B.C. Director of Religion, Rev. F. A.

Toscanini at the B.B.C.

THE greatest musical event of the year in broadcasting will be the appearance of Arturo Toscanini at six concerts during May and June, all to be given in the Queen's Hall, and each function having a Coronation flavour. It is doubtful if the B.B.C. would have been successful in securing Toscanini's services had it not been for the Royal event, which next month will draw tens of thousands to London from all parts of the world; as, although the first concert is not taking place until May 26th, many distinguished visitors will still be here at that time, and a considerable proportion of them who are musical enthusiasts will be staying on especially to attend.

Dates to be Noted

At the first concert, works by Busoni, Ravel and Beethoven will be played, and the concert will wind up with Brahms' First Symphony. The second concert, on May 28th, opens with Elgar's Introduction and Allegro for Strings, and includes the first performance in England of Tommasini's "Il Carnevale di

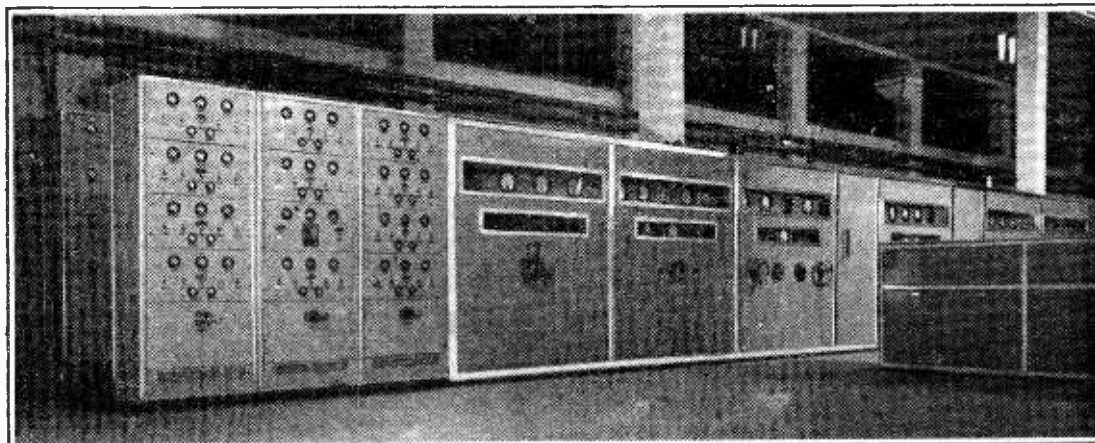

HIGH-POWERED TRANSMITTER for Empire Service. One of the three new transmitters showing (left) the crystal oscillator and frequency doubling stage; (centre) the intermediate amplifying and output stages; and (right) the modulator unit. All three transmitters are housed in one large new building which can be seen on the extreme right of the photograph on the opposite page.

being Mr. Bernard Reillic, leader of the Variety Orchestra. This is believed to be the first time that a variety orchestra has been represented in the Abbey.

Two Conductors

Another innovation will be the employment of two conductors. It is expected that Sir Adriaen Boult will assist Dr. Ernest Bullock, the Abbey organist, by reflecting his baton beats, to those parts of the orchestra which cannot see them direct. Dr. Bullock is, of course, chief conductor, but he will be concentrating on the choral side.

All-Sunday Rehearsal

The B.B.C. Symphony Orchestra will be represented in the Abbey, and there will also be players from the Empire Or-

Reimonger, stationed alongside Howard Marshall, will add some comments on the Service.

The Nerve Centre

Thirty-eight microphones will be utilised in various parts of the Abbey. The control room, on the south-west side of the nave, will have concentrated upon it all the microphones along the processional route, as well as those in the Abbey. A fancy figure might be given of the miles of wiring required for what our American friends would call the great "hook-up." But any estimate in advance is bound to be unreliable, seeing that many technical changes are certain to be made during the week prior to Coronation Day. Between five and ten miles of wiring may be required.

Venezia." On June 2nd the Sixth Symphony of Beethoven will be given, and his Third Symphony (Eroica) is included in the programme for June 4th. The remaining two concerts are on June 14th and 16th, the latter being an all-Wagner programme.

Televising Fire-walking

A TRENCH is to be dug in Alexandra Park for a fire-walking demonstration before the television camera on Tuesday next, April 20th, by Ahmed Hussain, whose prowess was recently the subject of a running commentary in sound broadcasting. Viewers will see Ahmed discard shoes and socks before essaying what many people regard as one of the most prodigious feats of mental concentration yet devised.

On the Short

NOTES FROM
A LISTENER'S LOG

Waves

CONDITIONS have remained generally good during the past fortnight, and reached a peak on Wednesday, April 7th, when W9XAZ on 26.4 Mc/s was excellent at times at 10 p.m.!

There was, however, a fade-out of 28 Mc/s signals due, apparently, to low ionisation levels between March 29th and April 5th, and in spite of considerable visible sunspot activity the limiting frequency for transatlantic communication was not appreciably higher than 23 Mc/s, with the peak around 19 Mc/s. This is, of course, still much higher than during the corresponding period last year, and at the moment of writing reception on 21 Mc/s (14 m.) is excellent from New York until well after midnight, checking on the performance of the commercial telegraph transmitters WIA and WQA. The Buenos Aires transmitter LSE on about 20 Mc/s has also been a very good signal in the late evening recently.

All this points to poor afternoon and early evening reception on 15 Mc/s or lower (20 metres or higher) during the coming summer from the U.S. and elsewhere, and it would appear that the new high-power transmitter which W2XE hopes to bring into use this month will be able to give a good account of itself this summer on 21.52 Mc/s.

It will also be very instructive to watch the performance of W3XAL on 17.78 Mc/s, especially if the European aerial is to be used at all extensively, since the summer ionisation level of the F or bending layer is said to be almost entirely a function of its temperature, there always being an excess of ionisation agent (i.e., ultra-violet light). The expansion of the upper region in summer, therefore, sets a definite limit to the highest

workable frequency, since the electron producing material (per cubic centimetre) is reduced.

The peak of maximum ionisation will probably occur in the sunspot minimum years during the equinoctial periods, i.e., optimum condition of sunlight against temperature, but during the sunspot maximum years, when the ionisation is less dependent on sunlight, the maximum will probably occur during midwinter, i.e., sunspot activity as the ionising agent coupled with minimum temperature, which means, of course, the greatest concentration of material (oxygen) per unit volume.

Best Summer Frequency

It is obvious that observations made on the limiting upper frequencies during the next two or three years can yield data of absorbing interest since, if it is true that the F region is always ionised to "saturation" in summer, then the upper limiting frequency for summer afternoon transmission will be the same in 1937-8 as in 1933-4—but the limiting frequency for winter afternoon transmission this year seems to have been very much higher than it was during 1933-4.

In any case next winter will definitely see a boom in ultra-high frequency reception and an increase in the number of stations using the 26 Mc/s (11 m.) broadcasting band.

Now to review the conditions during the past week: On Sunday, March 28th, 28 Mc/s signals from the States were fair at 4.20 p.m., W1COO and W3EMM being amongst the best 'phone stations. A little later, at 5.10 p.m., YR5AA, a 28 Mc/s 'phone station at Bucharest, Romania, suddenly began put-

ting in a R9+ signal into London and remained so for a considerable period, providing the best 10-metre reception of the afternoon.

At 8 p.m. W2XAD was strong, but obviously still improving, and finally became excellent by 9.40 p.m., at which time W3XAL was also excellent on 17.78 Mc/s, with quick fading at times.

The Spanish transmitter EAG2 (EDZ) was an enormous signal on 9.48 Mc/s approx., but badly overmodulated at 8 p.m., whilst EAG on 9.8 Mc/s was much poorer than its "sister" transmitter.

The 19 Mc/s Siamese transmitter at Bangkok was quite fair at 2 p.m. on Monday, March 29th, and a really first-class signal at 11 p.m. was CSW Lisbon on its 10 Mc/s channel, W1XK on 9.57 Mc/s was excellent, too, at this time, and the 11 p.m. news was taken from this station.

Reception was again good on Tuesday, and W2XAD was giving a fine performance on the "Mailbag" programme until midnight.

On Thursday, April 1st, W8XK was exceptionally good on 11.87 Mc/s at 12.30 a.m., but apart from this little was heard.

A unique "broadcast" from W2XAD/W3XAL was intercepted at 7 p.m. on Friday when both these transmitters were heard calling Berlin in German; this is the first time these transmitters have been heard on a point-to-point service since the old two-way tests between W2XAD and G5SW in 1926-27.

The Boston transmitter W1XAL was observed to be working on 15.25 Mc/s at 3 p.m. on Sunday, April 4th, a bad heterodyne (about 200 c/s or less) resulting between this station and the U.S.S.R. telephone transmitter RIM, Tashkent.

Fair results on Sunday were also obtained from YDC Batavia, Java, on 15.15 Mc/s at 11 p.m.

As mentioned at the beginning of these notes reception conditions became excellent again by April 6th, and in particular W2XAD as usual was outstanding.

Perhaps the most interesting signals heard were those of the new high-power Daventry transmitter's testing on GSG 17.79 Mc/s and GSO 15.18 Mc/s at about midnight.

ETHACOMBER.

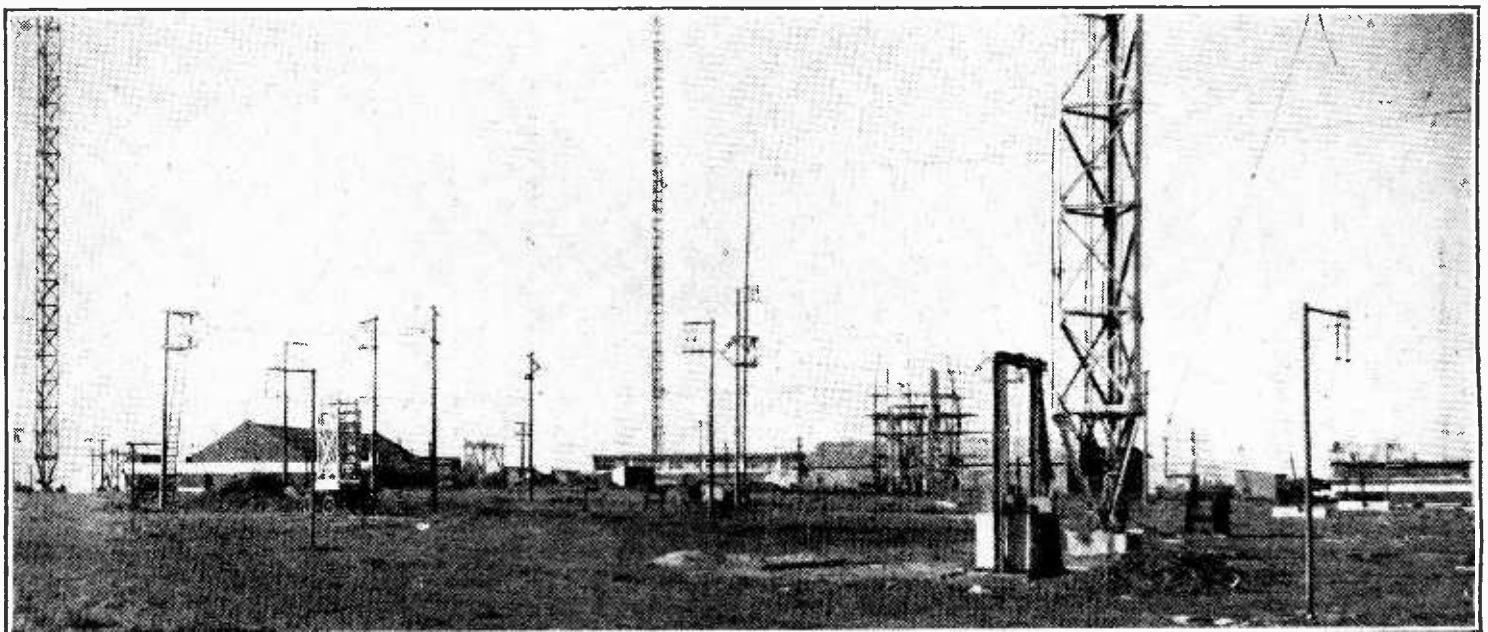

ACTIVITY is portrayed by this *Wireless World* close-up photograph of some of the feeders which run from the Empire Station's twenty-three aerial arrays. The station will be quite self-contained, as in an emergency two diesel engines can be brought into operation to supply enough power for the running of at least two of the transmitters.

Letters to the Editor

Horn-loaded MC Speakers

THE last two paragraphs of Mr. Voigt's letter on the subject of horn-loaded moving-coil loud speakers interested me considerably. It occurred to me when studying an advertisement of Voigt Patents, Ltd., just over two years ago, that if the two walls and ceiling at the corner of a room were used as a flare a horn with a quite low cut-off frequency could be built within a floor space that was tolerable in a small room.

I decided to build a horn experimentally on these lines, and found that the rate of expansion could be low enough to give a cut-off frequency of 37 cycles. The floor

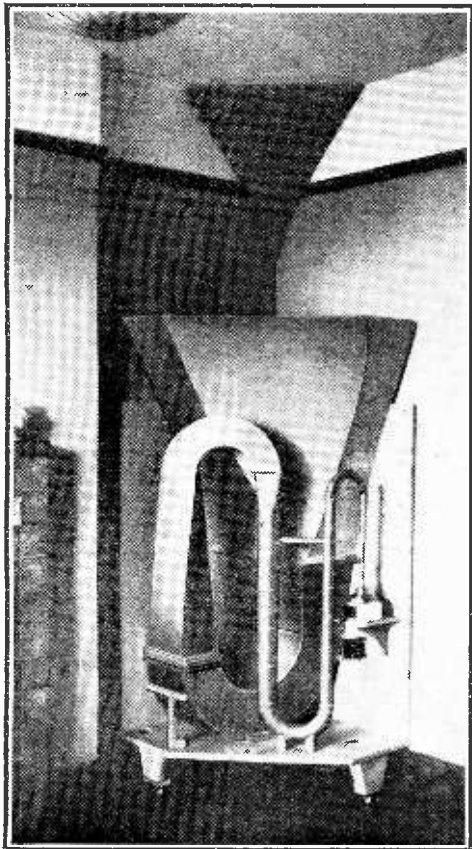

Mr. Maggs' experimental corner horn.

space occupied is a quarter of an octagon whose centre is at the corner of the room, and the mid-points of whose sides are 20in. from the corner. The actual mouth of the horn is about three feet from the ceiling, which gives about the correct expansion towards the virtual mouth. Organ pedal notes down to about 40 cycles are audible, and at 48 cycles the output is strong, due to a resonance.

It is difficult to say how far the small room is responsible for the resonances that do exist, but I think it has a considerable influence, since, as far as the lower frequencies are concerned at any rate, the horn has in effect a closed mouth.

The upper cut-off frequency occurs at about 1,400 cycles, and the remainder of the frequency band up to about 9,000 cycles is handled by a small horn mounted in the mouth of the large one.

I see no reason why a horn baffle for a moving-coil speaker of normal type could

The Editor does not hold himself responsible for the opinions of his correspondents

not equally well be designed to utilise the one-eighth sphere formed by the walls and ceiling as a flare. It is questionable, however, whether the reproduction would be so satisfying as that of a true-to-type horn and unit.

I enclose a photograph of the horn without its enclosing screen. I have since removed the triangular piece in the top corner and find the reproduction suffers little.

Rugby.

A. H. MAGGS.

I HAVE refrained from writing to you till this week in order to see if Mr. Voigt would cover in his reply an aspect of reproduction which I think is of great importance. I refer to transient response.

In spite of attempts at education, the public still assumes that a straight-line frequency response is the only ideal of a speaker. Although I am sure Mr. Barden knows better, he is helping to foster this viewpoint when he states that a speaker cannot be termed "high fidelity" unless it reproduces down to 40 c/s. Incidentally, I should like to ask why he doesn't mention the higher audio-frequencies, and state that high fidelity also embraces frequencies up to 20,000 c/s—a frequency which is quite audible—since, in the opinion of many enthusiasts, frequencies above 5,000 c/s are more important than those below 100 c/s, assuming no interference.

But even more important than frequency response (within reason, of course) is the response to transients.

To reproduce them does not necessarily require an unreasonable high-note response, though this is a common fallacy (Fourier's analysis is only applicable for wave shapes which are constant, do not bend back and are repeating, and cannot be used for a wave shape which is probably the one and only), and the goodness of a baffle speaker in this direction seems largely to be a matter of hit and miss. I know of a seven-year-old speaker of famous make which, in spite of a large and heavy diaphragm and deficient top, is greatly preferable to listen to than any of the modern wide-frequency examples yet heard just because of its comparatively better transient response.

Now, Mr. Voigt has not mentioned any of this in detail, probably because he was keeping to the subject matter of Mr. Barden's letter, but it is a very real advantage of the horn type that owing to the lighter weight of the moving parts and to the heavier damping it can respond to transients with little distortion.

J. K. TODD.

Polegate, Sussex.

"Hard Valve Time Bases"

The author of the article under this title which appeared in our issue of April 2nd, asks us to point out that the time base illustrated in Fig. 2 should have been acknowledged to Appleton, Watson-Watt and Herd.



MCCARTHY

Introducing
an exceptional new receiver
for the all-wave enthusiast!

For all-wave reception at its very best, exceptional range and power and large output, together with a number of interesting new features, few receivers will be found to equal the new

MCCARTHY 9-VALVE
ALL-WAVE SUPERHET

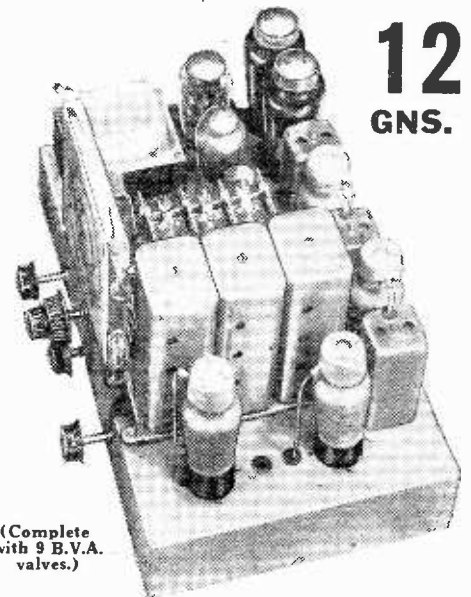

12
GNS.

(Complete with 9 B.V.A. valves.)

4 wavebands: 12.8-33, 29-80, 190-550, 800-2000 metres. Illuminated dial with principal station names. Separate coloured lights for each waveband.

Controls.—A feature of the receiver is the number of independent controls fitted, making it extremely interesting to operate. These include: sensitivity control (varying bias on R/F stage). Q.A.V.C. with manual muting control, and switch for inter-station noise suppression. Separate potentiometer bias controls for output valves. 5-position wave-change and gramophone switch. Progressive variable tone control operative on radio and gram.

Circuit in Brief.—Aerial input to pre-selector circuit, radio frequency amplifier, latest type triode-hexode frequency changer, 2 band-pass I.F.T. coupled I.F. amplifiers, double diode detector, L.F. amplifier, parafeed transformer-coupled push-pull triode output giving 6 watts.

Heavy cadmium-plated steel chassis. Finest components and workmanship throughout.

IMPORTANT

The prices at which McCarthy Chassis are advertised include Marconi Royalties. "Wireless World" readers should, for their own protection, make sure before purchasing any receiver that the quoted price includes the Royalty payment.

All McCarthy receivers supplied complete with valves, knobs, pilot lamps, leads, mains cable and plug. 12 months' guarantee.

Deferred terms on application, or through London Radio Supply Co., 11, Oat Lane, E.C.2.

Cash with order on 7 days' approval. Also write for illustrated catalogue of complete range of all McCarthy receivers.

MCCARTHY RADIO LTD.
44a, Westbourne Grove, London, W.2.

Telephone: Bayswater 3201/2.

G.E.C. AC TRANSPORTABLE 5

THE transportable type of receiver brings wireless into line with most other domestic electrical appliances which can be plugged into the nearest mains point and put into use without further ado. It can be conveniently carried from room to room, and its appeal is primarily to those for whom the erection of an aerial, if not actually impracticable, presents a responsibility from which they would gladly be relieved.

To obtain a performance comparable with that of the ordinary receiver working from an outdoor aerial the design of the circuit requires care. It goes without saying that a stage of RF amplification is necessary to compensate for the reduced pick-up of the comparatively small frame aerial, and the high magnification of the circuit as a whole raises its own special problems, principally those of

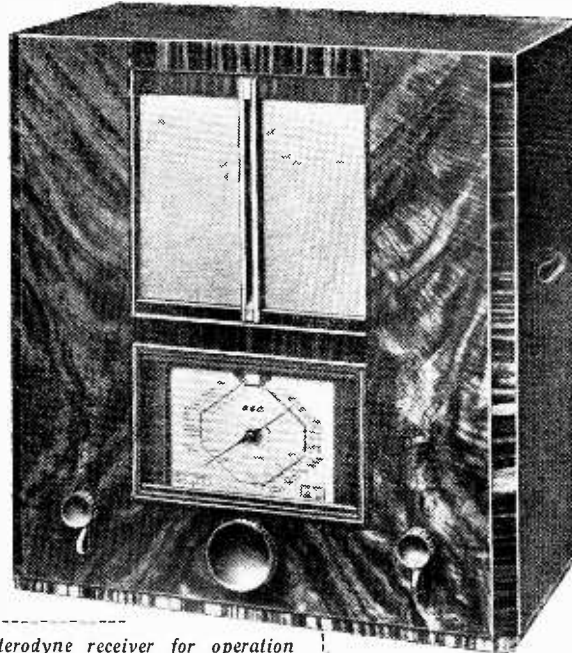

A Superheterodyne Operating Without Aerial or Earth Connections

stage of IF amplification makes use of a variable- μ pentode valve and is controlled by an AVC voltage which is less than that applied to the two preceding stages. No amplification is provided between the double-diode second detector and the high-slope pentode output valve, but the sensitivity of the receiver is such that an ample input voltage to the grid of the final stage is at all times available.

There is a continuously variable tone control across the output circuit, and as the loud speaker is of the permanent magnet type a smoothing choke has been provided. The power supply circuit follows conventional practice, and the mains transformer incorporates an electrostatic shield between primary and secondary windings.

The set is mounted on a turntable so that the best use can be made of the directional properties of the frame. Because of the effective automatic volume control the apparent signal strength of incoming stations is not appreciably affected by the orientation of the set, but the proportion of background noise can be considerably reduced by directing the frame aerial to the angle which gives maximum pick-up. As is only to be expected, a set of this type is rather more susceptible to stray magnetic fields from lift machinery, etc., but here again the directional properties of the frame can be

FEATURES.—*Type.*—Self-contained superheterodyne receiver for operation from AC mains. *Waveranges.*—(1) 200-550 metres. (2) 1,000-2,000 metres. *Circuit.*—Var.- μ pentode RF amplifier—triode-hexode frequency-changer—var.- μ pentode IF amplifier—double-diode second detector—pentode output valve. Full-wave valve rectifier. *Controls.*—(1) Tuning. (2) Combined volume control, muting and mains on-off switch. (3) Combined waverange switch and tone control. *Price.*—16 guineas. *Makers.*—General Electric Co., Ltd., Magnet House, Kingsway, London W.C.2.

achieving stability in a receiver which will be operated without an earth connection.

It will be seen from the circuit diagram that the valve used to amplify the incoming signal before passing it to the frequency-changer is a variable- μ RF pentode. Tuned grid coupling follows this stage, and the impedance of the anode choke is varied to give the best operating conditions on each of the two broadcast wavebands. Stabilising resistances are used both in this circuit and in the long-wave section of the frame. It is

possible to use the set with an outdoor aerial, and the coupling consists of a few turns adjacent to the main frame aerial windings.

A neon-type tuning indicator is connected across the anode circuit of the RF amplifier, and an adjustment is provided by a resistance with three alternative tapings controlled by a plug at the back of the chassis.

The frequency-changer is a triode-hexode, and two degrees of sensitivity or "muting" are provided by varying the standing bias of this stage. The single

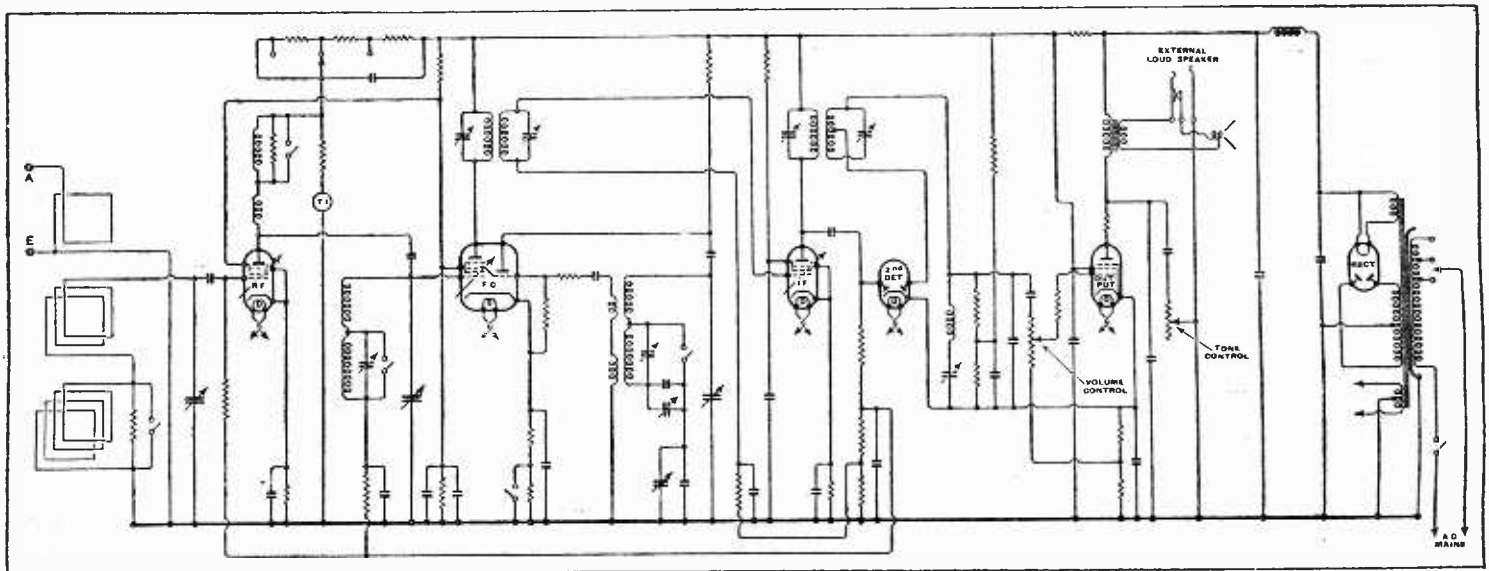

Complete circuit diagram. Although designed primarily for operation with the self-contained frame aerials, an external aerial and earth may be connected if desired.

G.E.C. AC Transportable 5—

put to useful purpose in reducing interference.

In most buildings there is a certain amount of metal work—water pipes, lighting conduits, etc.—which is a potential form of screening, and it is well worth while to experiment with alternative positions for the receiver in order to avoid possible blind spots.

Tested at first under the worst possible conditions in a steel-framed building, the set was nevertheless capable of providing a choice of at least eight foreign programmes on the medium waveband during the hours of daylight. Under conditions which would be closer approximation to those obtaining in a normal brick building, however, no fewer than twenty-

tuning stations accurately if accentuation of high audio frequencies is to be avoided. For this reason a tuning indicator with a somewhat more precise indication would have been welcomed. Provided the necessary care is taken in tuning, the set gives excellent quality of reproduction, and at exact resonance the full range of tone can be usefully employed. There is a welcome freedom from valve-generated harmonic distortion, and the reproduction is characterised by brightness and clarity as well as a quite useful low-frequency response.

There is provision for an extension loud speaker, though not for a gramophone pick-up. A special plug is provided which when first inserted enables both loud speakers to be operated, but when pushed

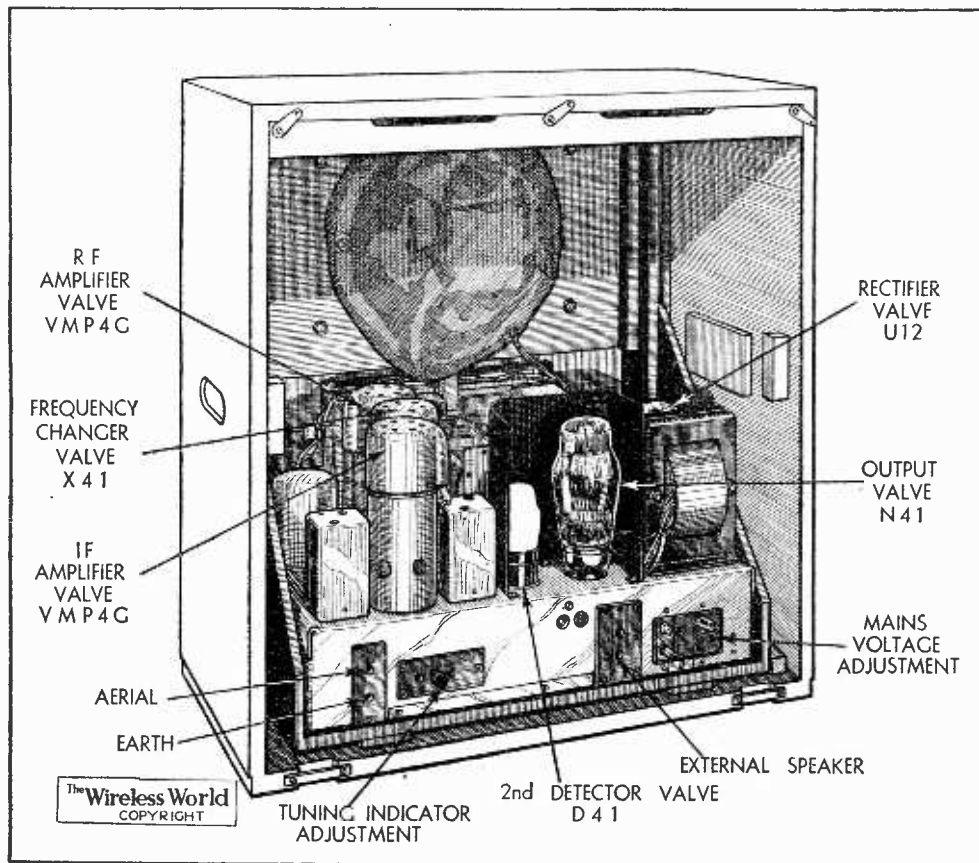

Loud speaker, frame aerial and chassis are mounted on a subsidiary framework which can be withdrawn from the cabinet as a unit.

five Continental stations were logged, and background noise was far less troublesome, particularly on the long-wave band.

Selectivity above the average

Selectivity was appreciably better than that which we have been accustomed to expect from the more popular makes of four- or five-valve superheterodynes designed for use on an outdoor aerial. In Central London the Brookmans Park stations were both completely lost when the tuning was shifted more than 12 kc/s on either side of the normal settings, so that considerably less than one 9-kilocycle channel was lost on account of the modulation spread of these stations.

Because of this high degree of selectivity rather more care is necessary in

fully home disconnects the internal loud speaker, leaving only the external speaker in operation. The receiver chassis complete with frame aerial and loud speaker can be withdrawn from the cabinet a complete unit. There is a mains voltage adjustment by means of which the standard model can be adapted for AC mains between 190-250 volts and 40-100 cycles. A special model is also available for mains voltages between 110 and 130 as well as between 210 and 230 volts, with the same latitude in the matter of frequency as that specified for the standard model. The cabinet, which is similar in appearance to that of the other table models in the G.E.C. range, is 19in. in height, with a width of 18in. and a depth of 11in. The total weight of the set is 42 lbs. and its current consumption approximately 70 watts.

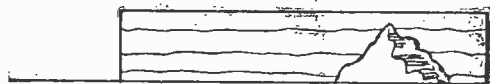

STABILITY

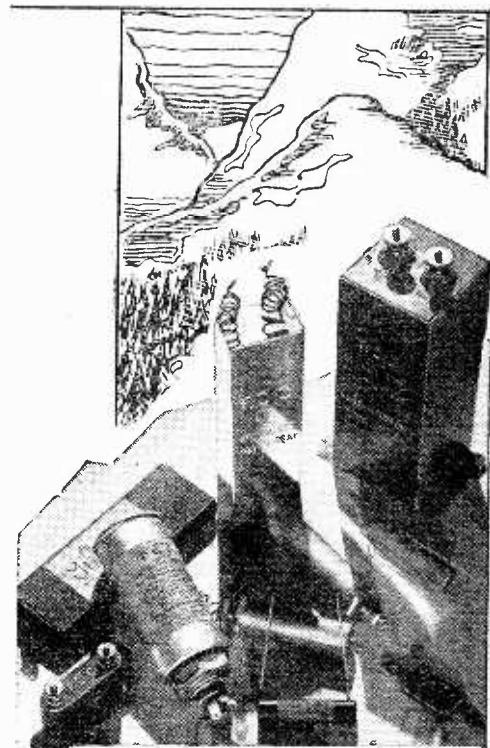

Stability. n.
The quality of being steady or constant, having durability or permanence.
—Dictionary

Let the dictionary guide you in the choice of your

CONDENSERS

MANY have been the makes of condensers... all good to look at... some good performers—for a time. Why aren't they on the market now? Because they lacked the quality of permanence... Inadequate experience, doubtful materials or unskilled workers left the job in some way incomplete... they failed in the test of time.

T.C.C. Condensers are the product of over 28 years' specialisation in condenser design and manufacture. That experience—that solid foundation is behind every T.C.C. Condenser. The result is a range second-to-none plus a reliability that is pre-eminent. For safety's sake use T.C.C.

T.C.C.
ALL-BRITISH
CONDENSERS

The Telegraph Condenser Co. Ltd., Wales Farm Road, N. Acton, W.3.

T 587 (CA)

Random Radiations

By
"DIALLIST"

Good Work

IT'S good to hear that the British Standards Institution is shortly to issue a special "Radio Interference Mark" for attachment to electrical apparatus of all kinds. Apparatus bearing this mark is guaranteed to be either non-radiating or to radiate so feebly that it does not reach the level at which officially recognised interference is caused. I hope that the existence of this mark will be given plenty of publicity and that the public will soon learn that it is in its own interests not to buy electrical appliances which do not bear it. My only regret is that agreement on what constitutes interference was not reached years ago and the mark issued then. As it is, thousands upon thousands of householders and others have bought apparatus that does radiate and radiate badly—in most instances without any idea that it could cause interference with radio reception. And one can't help blaming manufacturers who have marketed such things, well knowing the trouble that they were capable of causing.



Television Contour Maps

CONGRATULATIONS to the B.B.C. for having published in their 1937 Annual the first field-strength contour maps for 7.75 metre signals from the Alexandra Palace.¹ The work must have needed a great deal of skill, time and trouble, and the heartiest of pats on the back is due to those responsible. My only criticism is that though the maps contain the names of scores of towns and villages there are no dots to mark the precise positions of these. The maps cover the country within a radius of 25 to 30 miles of the Alexandra Palace. They well repay close examination, for this discloses several points of interest. Field strength, for instance, is particularly good towards the south-east of the transmitter. Here the 0.5 millivolt-per-metre line extends to well beyond 30 miles for a roof-height aerial in the district to the east of Rochester. In the south there are some striking "islands" of specially good field strength round Sutton, Tatsfield and Kingsdown. Two conclusions must be drawn from the contour maps. The first is that the erection of a high television aerial is a good investment; the second, that the service area of A.P. is proved to be larger and to have a shape more nearly approaching a circle than was originally anticipated.



Figuring it Out

THERE are some rather queer things about the wireless licence figures when you come to look into them. According to the B.B.C.'s calculations, for instance, the percentage of licences to households for the whole of the London Regional service area is 71, but for the London County Area itself, where at first blush you might expect the highest figure, it is only 57, as against 98 (I find that hard to believe!) for Hertfordshire and 37 for both Kent and Surrey.

¹ A reproduction of one of the maps appears in our review of the B.B.C. Annual on p. 387.—ED.

The explanation is probably that the London County Area, though its households are estimated to number 1,270,758, contains a very considerable number of poor people who cannot afford even the cheapest kind of wireless set. It is rather interesting to note that the highest percentage of licences is most likely to occur in the county in which a Regional transmitter is situated. Hertford, already mentioned, is the county of Brookmans Park; Warwickshire heads the list in the Midland Region with 85 per cent.; Yorkshire that of the North Region with 70 per cent.; Antrim that of Northern Ireland with 52 per cent. Stirlingshire with 69 per cent. is just beaten by Edinburgh's 71. In the West, Washford Cross is in Somerset, but both South Gloucester, with 74 per cent., and Devon, with 72, beat the "parent" county's 61. The most surprising case is that of Anglesea, which can raise only 19 per cent., despite its giving a home to Penmon, against Caernarvon's 80 per cent.

Which Regions "Pay"?

The licence totals for the seven regions show enormous differences, as is only to be expected considering their varying density of population. Most of them definitely pay their way; some barely do so, and one, at any rate, falls a good bit short. To the best of my ciphering ability I make the round figures for the Region's contributions

to the B.B.C.'s £2,509,750 from licence fees last year:—

London	£924,500
North	738,000
Midland	359,000
Scotland	203,000
West	152,750
Wales	102,000
N. Ireland	30,500
	£2,509,750

From this it seems that as Northern Ireland has its 100-kilowatt station at Lisnagarvey the Welsh demand for a high-powered Regional station of their very own is fully justified. At present the use of the West Regional for partly English and partly Welsh programmes is unsatisfactory, but all will be well when the new station near Start Point gets going and West Regional becomes definitely Welsh Regional.



Financing Television

THERE'S some talk of an increase in the cost of the receiving licence to 12s. 6d. in order to meet the cost of television during the next few years. But one need not be a prophet to predict that the licence will stay put at its present ten bob. Raising it by half a crown would be about as unpopular a move as the Chancellor of the Exchequer could make; many people can only just manage the present amount—ten shillings all at once is a big bit out of a smallish weekly wage—and the average listener might resent being called upon to pay extra for the development of something that is likely to be outside his reach for some time to come. But the money for television has to be found somehow; there can't be cheap television receivers until sales are big enough to make mass-production possible, and sales can't reach these dimensions unless and until the greater part of the population is brought within television service areas.

What's to be Done?

Roughly speaking, there ought to be about a million pounds available at once for the B.B.C. to be able to get on properly with the job of giving the country television. That sum certainly can't come out of the Corporation's revenue or out of its reserves. Part of it might be borrowed, but that should be avoided if possible. The only satisfactory solution seems to be to adopt the recommendation of the Ullswater Committee that the 25 per cent. of the licence fees that does not now go to the B.B.C. should be regarded as potentially available for their use when urgently required. There's no doubt that the need is urgent now, and that 25 per cent. represents just about the necessary £1,000,000. Given that amount to play with, the B.B.C. could have a Regional scheme for television in being before the end of next year.



Heart Records

STILL another application of the wireless valve—and this time of the gramophone record as well—to the art of healing was described recently in that rather

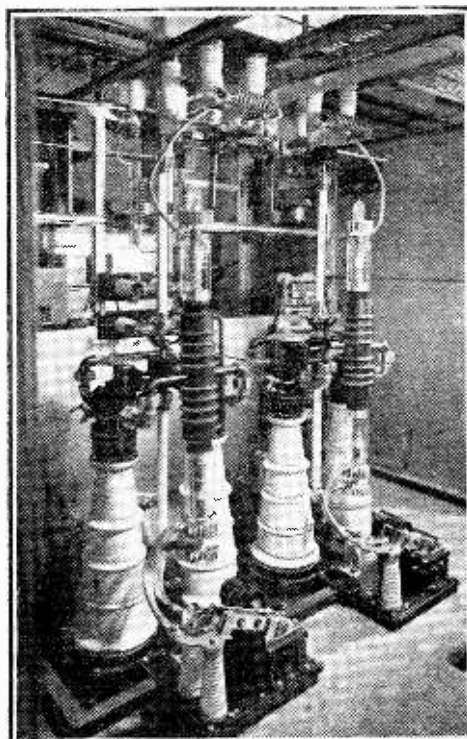

FINAL STAGE of the modulator unit of one of the new 50-kW Empire transmitters. The mechanical water interlocks, which prevent the power being switched on to the valves until the cooling water is flowing, are clearly visible. The engineers, in arranging for an average modulation of from 45 to 50 per cent. have slightly sacrificed quality of transmission for the sake of power, which is perhaps more important when dealing with long-distance short-wave transmissions.

grimly named medico's paper, *The Lancet*. The phonostethoscope is an apparatus for reproducing on the loud speaker the sounds made by a patient's heart. It has taken some time to evolve, since parasitic noises from other sources presented a knotty problem. However, that has been solved and the apparatus is now proving completely successful. One of its uses is to allow either the physician or a class of students to hear the heart noises enormously amplified by direct transmission from the patient. But they can also be recorded on the familiar wax disc with, if desired, superimposed

comments by a demonstrator. The usefulness of a series of such records to the medical student is obvious. It is now also possible for a heart specialist to take a record of the patient's heart sounds when he first sees him and to file it away for comparison with the results of subsequent tests.

Fluorescent Screens

Fig. 1 used in the above article in the issue of April 2nd was reproduced from the paper of Levy and West, referred to in the article.

The B.B.C.'s Annual Survey

B.B.C. Annual, 1937. Pp. 176, with 103 illustrations. The British Broadcasting Corporation, Broadcasting House, London, W.1. Price 2s. 6d.; by post 3s.

IT would be legitimate to summarise the contents of this book as "all about British broadcasting"; as a make-weight there is quite a lengthy section on the various aspects of Empire broadcasting as well. Though first and foremost a survey of the past year's work, the Annual is also a reference book on things of the present that can be depended on to provide an answer to any reasonable question likely to be asked on the B.B.C.'s activities. A useful reminder of various transmission times is given.

Organisation, finance, engineering, public and foreign relations are all dealt with, and,

naturally enough, a large part of the book is devoted to matter relating to programmes. In the technical section there is a particularly interesting article on studio design in which the new type of hall, in which one end is acoustically "live" and the other "dead," is described at length. The maps showing measured field strength of the London television station, though relating to the sound transmitter, would tend to prove that the consistent range is limited to some 25 miles (allowing a minimum field strength of about 1 millivolt per metre).

Illustration and make-up is of a high standard, and the 1937 Annual is a remarkably good half-a-crown's worth to anyone who takes any serious interest in broadcasting.
H. F. S.

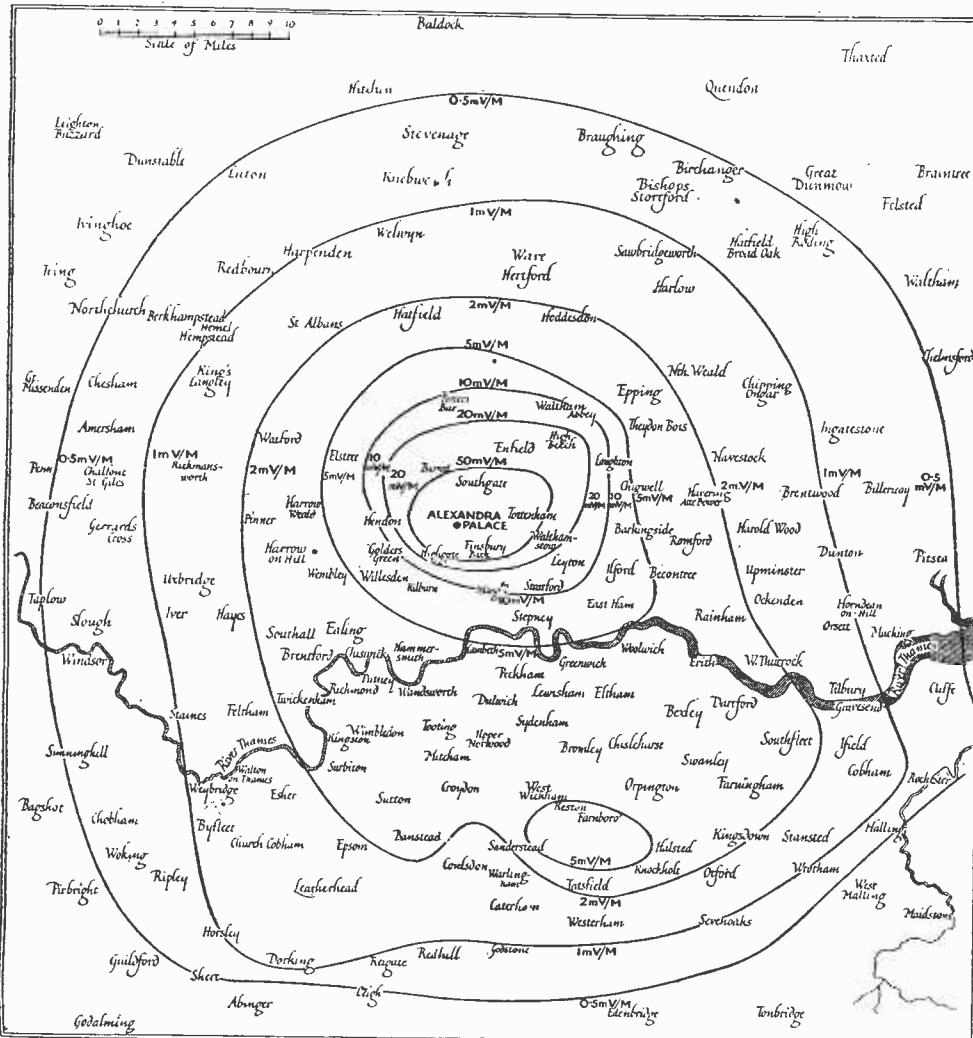

One of the television field-strength maps reproduced (on a slightly reduced scale) from the B.B.C. Annual, 1937. The contours have been corrected to show estimated field strength at roof level (10 to 15 metres above ground).

POINTS OF IMPORTANCE in the Rola G.12

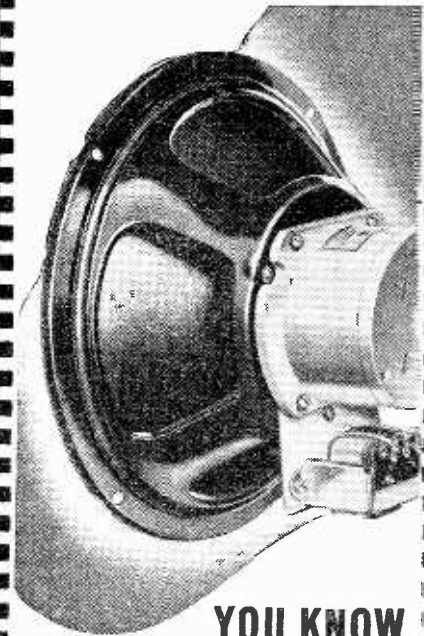

YOU KNOW A GOOD COIN BY ITS RING ...

and a good speaker by its tone, but the best guarantee of a good receiver is the type of speaker with which it is equipped. For this item is usually the first on which a manufacturer economises, and if you choose a set with a really first-class speaker you can be sure of being on safe ground. Of course, the best plan of all is to make sure that your set is fitted with a Rola G.12, for no better reproducer is available to-day. Many manufacturers have found that the installation of G.12s has been followed by a phenomenal increase in the sales of the particular models so equipped. From either point of view, that of manufacturer or listener, you will find that the specification of G.12s is a policy that pays.

- G.12 P.M. (as illustrated) with Transformer ... £5 5 0
- G.12 P.M. less Transformer ... £4 16 0
- G.12 D.C. Complete with Transformer, Mounting Stand, Handle and Base ... £5 5 0
- G.12 D.C. with Mounting Stand, Handle and Base, but without Transformer ... £4 16 0
- G.12 D.C. Stripped, but with Transformer ... £4 4 0
- G.12 D.C. Stripped and without Transformer ... £3 15 0

(When ordering please state Field Resistance and Impedance of Transformer required.)

For Public Address work both the P.M. and Energised Models can be supplied with a 15 ohm Voice Coil at an additional charge of 3/-.

Write for Folder A.
OVER 8 MILLION IN USE

ROLA

The World's Finest Reproducers

THE BRITISH ROLA CO., LTD.
MINERVA ROAD, PARK ROYAL, N.W. 10.
PHONE WILLESDEN 4322-3-4-5-6

Recent Inventions

The British abstracts published here are prepared, with the permission of the Controller of H.M. Stationery Office, from Specifications obtainable at the Patent Office, 25, Southampton Buildings, London, W.C.2, price 1/- each. A selection of patents issued in U.S.A. is also included.

Brief descriptions of the more interesting radio devices and improvements issued as patents will be included in this section.

"PROSPECTING" BY WIRELESS

THE location of an invisible conductor, such as a buried mass of metal, or an aeroplane flying in fog, is ascertained by observing the disposition of the nodes and loops of a standing-wave system, which is created between it and a short-wave transmitter by the outgoing and reflected radiation.

The transmitted short-wave beam is modulated by a longer wave, and advantage is taken of the fact that whilst the beam as a whole can be sharply concentrated in any desired direction, and is reflected as though it were not modulated, yet the standing-waves set up by the modulating frequencies can be more conveniently used for making the desired measurements.

Telefunken Ges. für drahtlose Telegraphie m.b.h. Convention date (Germany) May 18th, 1935. No. 457737.

MUTING CIRCUITS

INTERSTATION "noise" is suppressed by means of a gas-filled discharge tube, which is connected in the low-frequency part of a wireless set and acts as an attenuating device. As shown in the simplified diagram, the low-frequency output from the detector valve D passes through a condenser C to the amplifier V₁. The DC component is, however, passed through a resistance R, and the voltage developed is applied, in part, as an AVC bias to the high-frequency amplifier V. It is also applied in part to control the impedance of a valve VC in series with the attenuator discharge tube T.

In the absence of any signal, the impedance of the valve VC is low and the voltage-drop across the discharge tube T is sufficient to ionise the contained gas. This acts as a shunt across the input of the amplifier V₁ and thus meeting the loud speaker. Directly a worthwhile signal is tuned in, the bias applied to the grid of the valve VC raises the impedance of that valve, so that the discharge tube T de-ionises and leaves the

received signals free to pass through the LF amplifiers to the loud speaker in the ordinary way.

Standard Telephones & Cables, Ltd. (assignees of H.M.W.E. Reichle and G. N. Thayer). Convention date (U.S.A.) June 19th, 1935. No. 458235.

CATHODE-RAY TUBES

A HIGH-SPEED cathode-ray tube, particularly suitable for measuring "transients," is constructed entirely of metal and porcelain, without glass, this favouring the production of a more intense beam of electrons.

In such tubes it is found that the electron stream contains a proportion of atomic particles, called "retrograde rays," which gain or lose electric charges as they pass through the gas, and so tend to "fog" the screen or photographic film on which the record is made, because they are not effectively controlled by the magnetic or electrostatic fields applied to the deflecting electrodes.

According to the invention the axis of the discharge path is slightly inclined to the main axis of the tube, so that any "heavy" or "neutral" particles of the kind in question are "trapped" by an apertured diaphragm and are thus prevented from reaching the sensitised screen or recording film.

R. F. Whelpton and Metropolitan Vickers Electrical Co., Ltd. Application date June 24th, 1935. No. 458270.

LOUD SPEAKERS

A LOUD-SPEAKER movement of high acoustic capacity consists of a pot-magnet M which is constantly rotated through a pulley P from a motor (not shown). The speech-coils C are carried inside the magnet, which is fitted with a yoke Y, also driven from the pulley-shaft through a pin K. A thin magnetic disc D is fitted between the magnet M and yoke Y, so that the applied signal currents create a frictional torque on the disc which is, in turn, communicated to the

diaphragm A of the loud speaker.

Speech currents are fed to the coils C through a contact ring R on which a brush connected to the coil lightly rests. The other terminal of the input is taken to the disc D, as shown, this being also fitted with a sliding contact. The arrangement allows the inertia of the oscillating parts of the move-

made to deliberately reduce the intensity of the picture signals immediately preceding any abrupt change from a high-light to a low-light background. For instance, in the case of a film a certain number of the frames preceding the change-over are rendered opaque. In the case of the direct transmission of an outdoor scene

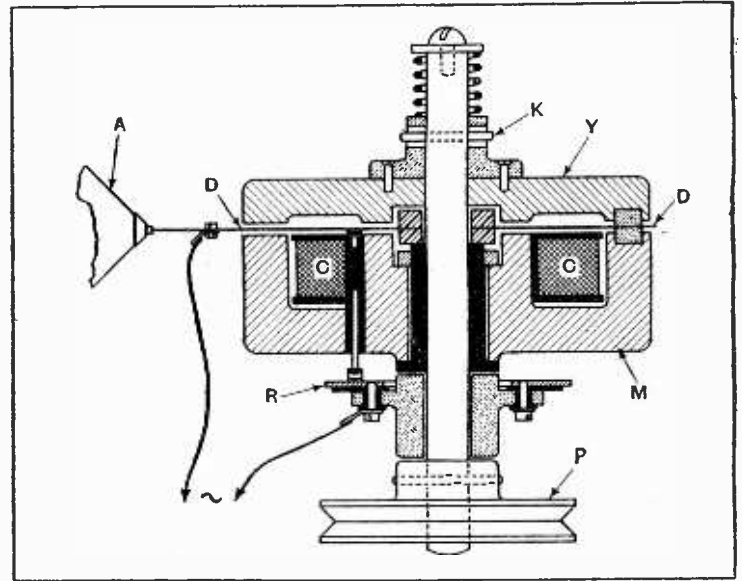

Details of the loud speaker described in Patent No. 458287.

ment to be kept extremely small. Also, since the mechanical force exerted on the diaphragm is derived from a pure pressure between frictional surfaces, the disc D can be made very thin and light.

H. Vogt. Convention dates (Germany) November 3rd, 1934, and October 1st, 1935. No. 458287.

a suitable shutter or filter is interposed, to lessen the value of the light falling on the photo-electric cell.

Scophony, Ltd., J. D. Baynes, and G. Wickenhauser. Application date September 27th, 1935. No. 458382.

TELEVISION

WHEN a cinema film is being televised, abrupt changes of scene may occur, which are not followed "smoothly" on the fluorescent screen of the receiver, owing to what is called "after-glow." The same may happen when the transmission of an out-of-doors event is followed by a scene from a comparatively dimly lit interior.

To remedy this, provision is

AIRCRAFT WIRELESS

THE trailing aerial used in an aeroplane is released or wound in by a remote-control device acting through a clutch. The latter is arranged between the winding crank and the reel, so that a single flexible shaft serves either to wind up the aerial, or to let it out, according to the direction in which the crank handle of the remote control device is turned.

Romeyloewerk Ges. für drahtlose Telegraphie. Convention date (Germany) June 5th, 1935. No. 458018.

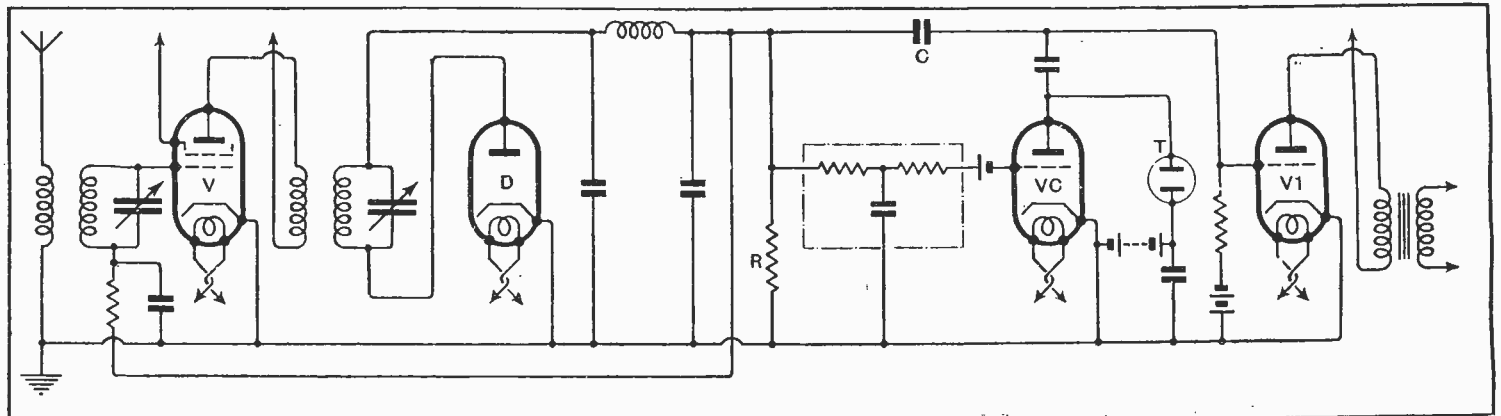

Simplified circuit of system for suppression of inter-station noise.



Outstanding in every way!

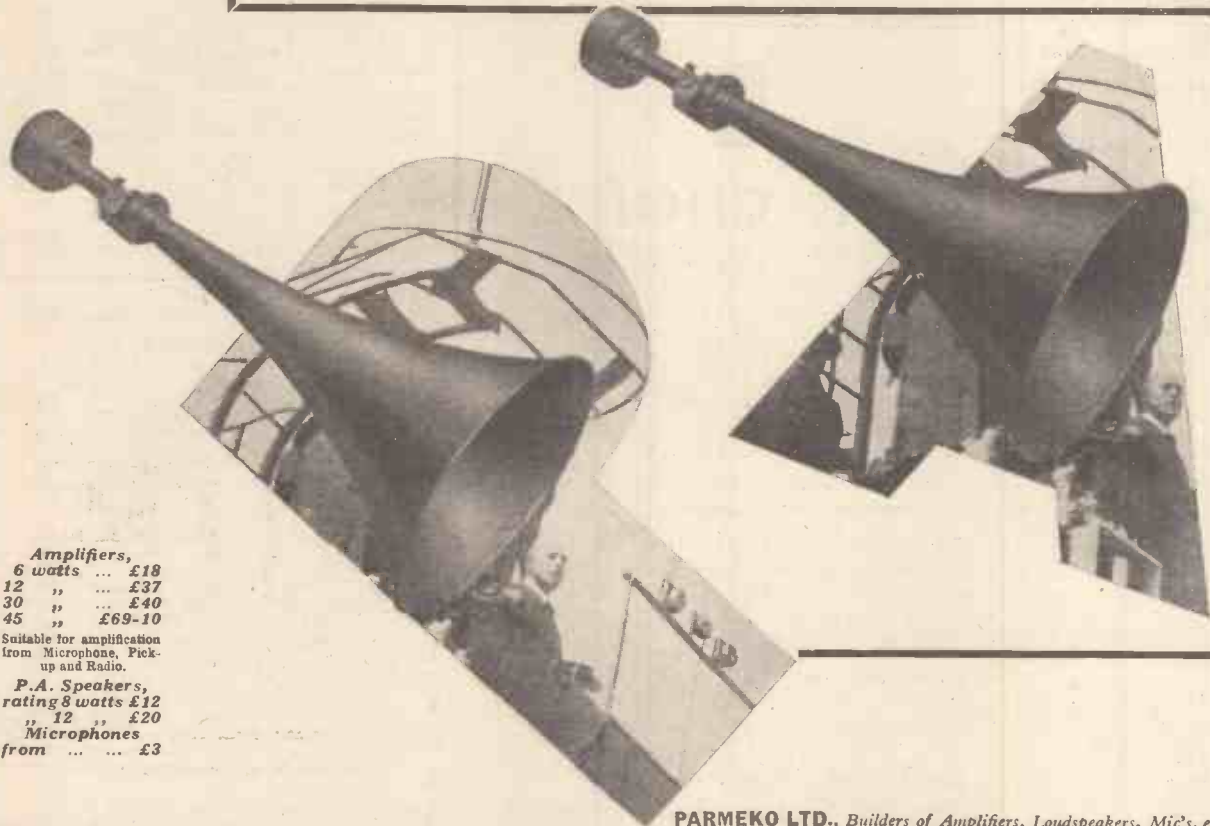

PARMEKO P.A. equipment is a revelation of the true thoroughbred—distinguished for its perfect tone, unlimited power and unapproachable in service.

PARMEKO is the best that money can buy—a demonstration will prove this to you.

Amplifiers,
 6 watts ... £18
 12 " ... £37
 30 " ... £40
 45 " ... £69-10
 Suitable for amplification from Microphone, Pick-up and Radio.
P.A. Speakers,
 rating 8 watts £12
 " 12 " £20
Microphones
 from ... £3

PARMEKO LTD., Builders of Amplifiers, Loudspeakers, Mic's, etc., AYLESTONE PARK, Leicester

100% RELIABLE - IF IT'S ELECTRIC SOLDERING

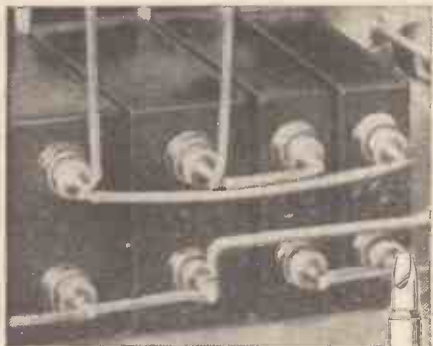

Every contact a neat, simple and lasting job—that's what Solon electric soldering gives you. Maintains constant heat where you want it—element clamped within the bit concentrates all heat at point.

8/6 Sold with Instruction Book.
 65 watts Resin-cored Solder, 6 ft. Flex and Standard Lamp Adaptor.



W. T. Henley's Telegraph Works Co. Ltd., (Dept. Y4/70/E.), Holborn Viaduct, London, E.C.1.

AMERICAN SET OWNERS INSIST ON

THE WORLD'S STANDARD VALVE



The Standard Valve for Standard Sets
FOR RELIABLE CONSISTENT PERFORMANCE

UNIVERSAL RADIO DISTRIBUTORS LTD.
 24, FITZROY SQUARE, LONDON, W.1.

BULGIN RADIO COMPONENTS

MICA DIELECTRIC TRIMMER OR PADDER CONDENSERS



These Mica Dielectric Trimmers are ideal for adding to any set to secure ganging, or for padding adjustments, etc. The low loss body is moulded in "Micro-loss" and is fitted with a one-hole fixing bush. Best ruby mica dielectric with means to prevent short circuiting or plate jamming is employed.

TYPES AVAILABLE.

List No.	Capacity.	Price.
C.P.2.	0.00016 μ F max.	2/4
C.P.3.	0.0003 " "	2/4
C.P.4.	0.0006 " "	2/7 $\frac{1}{2}$
C.P.5.	0.001 " "	2/7 $\frac{1}{2}$
C.P.6.	0.002 " "	2/11
C.P.7.	0.003 " "	3/2 $\frac{1}{2}$

To A. F. BULGIN & Co., Ltd.
 Abbey Road, Barking, Essex.

Please forward me a copy of your complete Catalogue No. 156 for which I enclose 3d. in stamps.

Name.....
 Address.....
 [W]

MISCELLANEOUS ADVERTISEMENTS

NOTICES

THE CHARGE FOR ADVERTISEMENTS in these columns is

12 words or less, 3/- and 3d. for every additional word.

Each paragraph is charged separately and name and address must be counted.

The proprietors retain the right to refuse or withdraw advertisements at their discretion.

Postal Orders and Cheques sent in payment for advertisements should be made payable to **LIFFE & SONS, Ltd.**, and crossed **& Co.** Notes being untraceable if lost in transit should not be sent as remittances.

NEW RECEIVERS AND AMPLIFIERS

A.
A.

DEGALLIER'S, Ltd., the firm for reliable short wave radio, have on show in London the largest selection of fully guaranteed brand new all-wave receivers; callers invited to handle all these at their leisure without obligation to purchase; all S.W. receivers will get stations on the low bands, including the Americas, etc. Closed all day Mondays. All goods cash with order or c.o.d. Hand-somely illustrated catalogues forwarded on receipt of large stamped addressed envelope or stamp 2/6d. Our models receive American transmissions at full programme strength; demonstrations daily after 4.30.

6/6 Each.—Valves for American receivers, all guaranteed, each a first, no seconds or throw-outs; for every known set from 1927-37; metal, metal glass, glass counterparts, and glass; in ordering just state type and number, we have it, all post paid; line cords for all midgets, 4/6 each.

£3/10—T.R.F. Midget receiver. "The smallest of its type in the world," medium and long wavebands, moving coil speaker, 2 watts output, no earth required, compact and transportable, leather cloth covered, obtainable in various colours; carriage 1/-.
£7/7—Table model six-valve all-wave superhet, tuning 16½-50, 200-250, 800-2,000 metres, high efficiency resistance-capacity circuit with A.V.C., station calibrated dial, 8in. moving coil speaker, cabinet of handsome appearance and super acoustic, 17x13x9½, operates on A.C. or D.C. mains, 200-250 volts; never before such tone from a D.C. receiver, carriage 4/6.

13 Gns.—The new Challenger 8 (type 800) table model De Luxe, 22x18x12, high fidelity 8-valve superhet, A.C. 200-250 volts, waveband coverage 11-32, 27-65, 190-550, 900-2,000 metres, simplified centralised tuning, super slow motion vernier slow-fast tuning dial calibrated in metres, with station names, self contained control panel, perfect tone quality at low volume, new type, M.C. 10in. speaker, from a whisper to 8 watts pure undistorted tone, no overloading at full volume, oscillator fundamental without use of harmonics, persistent oscillator of highest output, isolating filters eliminate oscillation and motor boating, fully delayed A.V.C., P.T.U. terminals (switching and volume control incorporated in the front panel), absolute minimum of noise, sensitivity control for noise suppression. Reinforced capacitors prevent drift, pre-aged intermediate frequency transformers, I.F. barrier diodes, anchor coil leads, plug-in loudspeaker, moisture sealed out by tropical zone impregnation, self healing electrolytic condensers. One complete chassis of dreadnought construction, moderate voltages assure full valve life, economical to operate, 75 watts consumption, correct valve selection, no compromise, no hum, full weight transformers, true push-pull, stabilised H.T. supply, stabilised biases, ceramic coil insulation, fully loaded plate coils give maximum gain, pre-balanced coil assembly, sealed insulation, thin laminations of special silico steel, 7 k.c. selectivity, fractional microvolt sensitivity, shielded switching permits high gain, positive silver plated contacts eliminates switch noises, audio frequency range 30-8,000 cycles, diode detection, Prizmatone high fidelity, R.F. selector stages on all bands; carriage 5/6.

£12/18—"800" chassis valves and 10in. speaker with all escutcheons, etc.; carriage 4/-.
£14/18—"800" chassis valves and G.12 12in. Rola high fidelity speaker; carriage 6/-.
£17/17—Challenger "800C" Console, height 3ft. 6in., width 24in., depth 12½in.; this is the 800 chassis with G.12 Rola; carriage and crate 10/-.

NOTE—The Challenger 800 is available in 11-valve A.C./D.C. 200-250 volts, at an additional cost of 20/- on each model.

29 Gns.—Challenger "800RG" radiogram, with automatic changer "Garrard", this job also incorporates the G.12 high fidelity Rola, carriage and crate 15/- A.C./D.C. model £2 extra.

14 Gns.—Challenger 381 8-valve 14-2,060 metres Poly-chromatic dial scale, improved vision master, beam power output, band spread Magna dial and second-hand magic eye tuning, automatic band indicator, high image frequency suppression, hair line selectivity, 5 k.c. separation; carriage 5/6; less cabinet, £13/18; carriage 4/-.

THE Following Bargains Cannot be Repeated, owing to the fact that they are samples; these are also covered by the usual guarantee in Great Britain against faulty workmanship and materials; owing to the weight and difficulty in packing, these are available to callers only, and a visit to our showrooms will be well worth while.

(This advertisement continued in third column.)



THE CHOICE

Some of our correspondents have misunderstood. Because for the last few weeks we have been devoting much space to the new M.A. receivers, they ask if the S.A. models are to be discontinued.

Quite definitely, the answer is NO.

Each One to his Taste

For clients who want choice of many programmes we recommend the M.A.

For those who want simply the nearest British stations, we recommend the S.A. if interference is not bad, the M.A. if it is bad. Reasons? Simple enough. Good as the M.A. is, the S.A. gives fractionally better response, and it is lower-priced. But it is not designed to cut out bad interference.

An Embarrassment of Riches

Similarly, as to choosing between Standard and Duode speakers, the Duode is better, but the improvement is mainly in the extreme treble. If your interference conditions, your receiver and your ear allow you to take full advantage of the frequencies above, say, 8 kC, then the extra performance of the Duode is worth the higher price and complication, and slightly decreased robustness as compared with the standard P.M.

The comparative prices are:

M.A. receiver, with power pack and all valves, 7-watt	£32 10 0
Do. do. 12-watt	£35 0 0
S.A. receiver, complete with valves, 7-watt	£25 0 0
Do. do. 12-watt	£27 10 0
Duode-de-luxe speaker, 20-watt, D.C. model	£6 10 0
Rectifier for A.C. feed	£1 5 0
Transformer to suit your valves (any standard type)	£1 0 0

COME AND HEAR THEM



HARTLEY TURNER RADIO LTD.,

THORBURY ROAD,
ISLEWORTH, MIDDLESEX.

Telephone: HOUnslow 4488

ADVERTISEMENTS for these columns are accepted up to FIRST POST on MONDAY MORNING (previous to date of issue) at the Head Offices of "The Wireless World," Dorset House, Stamford Street, London, S.E.1, or on SATURDAY MORNING at the Branch Offices, 19, Hertford Street, Coventry; Guildhall Buildings, Navigation Street, Birmingham, 2; 260, Deansgate, Manchester, 3; 28a, Renfield Street, Glasgow, C.2.

The proprietors are not responsible for clerical or printers' errors, although every care is taken to avoid mistakes.

For particulars of Box Number Advertisements and Deposit System see previous issues.

NEW RECEIVERS AND AMPLIFIERS

(This advertisement continued from first column.)

£37/10—Six only 1937 24-valve Garod receivers, 2 twin chassis and 2 Public Address speakers, 5 wavebands covering 5-2,000 metres, 60 watts undistorted output; this chassis is also available in Console form at £7 extra, this cabinet alone cost to make over £15.

£35—Three only 24-valve Lafayette twin chassis and 2 speakers, 5 wavebands, 8-2,000 metres, 30 watts undistorted; also 1 Console at £41/10, and 1 radiogram with record changer at £50.

DEGALLIER'S, Ltd., 18, Connaught St., Marble Arch, London, W.2. Paddington 2745. [4223]

A.
AIR KING.

ALL Models Feature Beam Tuning, Magic Eye indicator, grammo pick-up connections, and special output valves.

ALL Sets Fully Guaranteed; H.P. terms available from 3/- per week.

WHOLESALE and Trade Enquiries Invited; generous terms.

ALL Types of American Valves Stocked; write for lists to

AIR KING RADIO, 115, Shaftesbury Av., Cambridge Circus, W.C.2. Phone: Temple Bar 4875 (2 lines). All receivers assembled in England. [3406]

ANGLO AMERICAN RADIO Offer the Finest Range of Bargains in Radio Chassis and Receivers.

Special Cash Bargains—Limited number only; cash or c.o.d.; post 1/-, secure yours now.

37/6—Powerful 3-valve all-wave battery chassis, 12-2,000 metres, grammo. band-spread, 7½in. dial with short wave station names and map tuning scale, complete with valves; an unprecedented offer.

21/-—Superheterodyne short-wave converters, 7-200 metres, 5in. dial with band-spread, operates in front of any superhet or receiver with H.P. stage, mains or battery, complete with valves and cabinets, aerial tested.

4 D. in Stamps Enclosed Brings Our New Coronation Bargain Catalogue, 2 colours, fully illustrated; complete receivers 4v. A.C./D.C. to 10-valve 5 band, 10 watt at lowest prices in the country.

IF in Town Visit Our New Showroom and Coronation Display at Banham House, 39, New Oxford St.; full demonstrations without obligation.

ANGLO AMERICAN RADIO (AND MOTORS), Ltd. (Dept. W.13), Albion House, 59, New Oxford St., London, W.C.1. (Temple Bar 3231.) [4146]

ALERT RADIO Co.

COMMUNICATION Receivers, all-wave chassis, complete receivers of all types, American valves, spares and service; we also have a few reconditioned receivers.—21, East Rd., N.1. Clerkenwell 4871. [3787]

ROYAL RADIO Co.

ALL-WAVE Receivers, suitable for use on ships, as supplied to officers of many shipping lines.

OUR 8 and 10 Metal Valve All-wave Receivers; 15-2,000 metres, acknowledged by the trade as the best for range, tone, and general performance.

LATEST 6-valve Car Radio, A.V.C., remote control, no suppressors required.

A FULL Range of the World Famous Ferguson and Pilot Models Stocked.

ALL Sets Fully Guaranteed by Ourselves.

ALL Types of American Valves Stocked.

PAY Us a Visit Any Time, or send for full range catalogue; 1½d. stamp will be appreciated.

ROYAL RADIO Co., 5, Buckingham Rd., South Woodford, London, E.18. Phone: Buckhurst 2736. [4111]

ALL Hallierafters in Stock.

SKYBUDDY, £9; Skychief, £12/15; Challenger, £24; Super Skyrider, £28/10; Ultra, £32/15; Commercial, £32/15.

AMERICAN Spares Every Description.

RADIOGRAPHIC, Ltd., 66, Osborne St., Glasgow, C.1. [4249]

NEW RECEIVERS AND AMPLIFIERS

"SERVICE With a Smile."

HENRY FORD RADIO, Ltd.**ELECTRONIC House, 22, Howland St., Tottenham Court Rd., W.1. Museum 5675. [0511]****HARMAUR RADIO** for Wireless Receivers from £3/3; Raytheon glass and metal valves and all components; trade enquiries.**THE HARMAUR RADIO Co., Ltd., 8, Clifford St., New Bond St., London, W.1. [0499]****£7/5**.—Six-valve all-wave chassis with Bin. Rola, B.V.A. valves, royalties paid, twelve months' guarantee.—Coulphone, Hutton, Preston. [4229]**McCarthy New Series of A.C. Universal**, battery, all-wave and other receivers, many refinements, several interesting new models.**IMPORTANT**—All prices quoted for McCarthy chassis include Marconi royalty payments.**McCarthy All-wave Battery Superhet**, with R.F. stage, £7; separate triode oscillator, L.F. stage, pentode output, ext. speaker and gram. sockets, etc.; equals mains performance.**McCarthy 6-valve All-wave Superhet**, with R.F. stage, £8/5; A.C. or universal, iron-cored I.F. coils, Litz-wound tuning coils, illuminated "Airplane" dial, triode-hexode frequency changer, double band-pass coupled I.F. amplifier, L.F. stage, pentode output, D.A.V.C., tone control, ext. speaker and gram. sockets, etc.; performance equals many 8-valve receivers.**McCarthy Special 7-valve All-waver**, with R.F. stage, four wavebands, many interesting new features; £10/10; full particulars on application.**McCarthy Super 9-valve All-waver**, with push-pull triode output; £12/12; a set for the connoisseur!—For full particulars see McCarthy advertisement, page 383.**All McCarthy Receivers on Heavy Cadmium-plated Steel Chassis**; quality components and B.V.A. valves throughout.**Many Other McCarthy Models**.—Write for complete catalogue.**McCarthy Radio, Ltd., 44a, Westbourne Grove, London, W.2. [4225]****Peerless Chassis De Luxe Model, 1936**, 11 valves, 12½in. speaker, 4 wavebands, 18 watts output, specially made for short-wave reception; come up and test it; £14/14.—Kay, 47, High St., Camden Town, N.W.1. [4221]**TRANS-ATLANTIC RADIO** For the Finest All-wave and Mains-compact Receivers, from £59/6; lowest prices American valves and components; prompt radio repairs.—Trans-Atlantic Radio Co., 15, Percy St., W.1. Museum 3096. [4235]**Pilot, Ferguson, Belmont, Pegasus, and Air King** all-waves lead the field; our deliveries are prompt in original cartons, with full guarantees; your trade card will bring our wholesale catalogue from the authorised distributors.—Leonard Heys, 36, Henry St., Blackpool. [0530]**COMMUNICATION Receivers, Hammarlund, National, Hallcrafters, R.M.E.69, ToBe-Deutschmann**; transmitters, Collins 45A, Peerless DX20, or built to order; American valves, microphones, Eddystone components.—A.C.S., Ltd., 52-4, Widmore Rd., Bromley. Phone: Ravensbourne 0156 [0550]

RECEIVERS AND AMPLIFIERS CLEARANCE, SURPLUS, ETC.

HENRY'S.**1937 Regentone De Luxe Model A.C. 200-250 3 waveband Superhet**, 5 valves, 17.5 to 2,000 metres, handsome cabinet; list 12½ gns., our price £7.**1937 Regentone 3 Waveband, A.C. 200-250, 17.5 to 2,000 metres, thermometer tuning**; list 9 gns., £4/10.**1936 Regentone 5-valve Consolette, A.C. 200-250, thermometer tuning**; list £10/10, £4.**1937 Regentone 3-valve Battery Set, H.F. pentode, det. and pentode output, moving coil speaker, thermometer tuning**; list £6/2/6, £3.**FARREX Short Wave Units for A.C. Mains or Battery Sets**; list £3/3, only a few left for 30/.**HENRY'S, 72, Wellington Av., London, N.15. Stamford Hill 2907. [4075]****CLEARANCE List (Trade Only)**.—Write Leonard Heys, 36, Henry St., Blackpool. [0527]**10-WATT Quality Push-pull A.C. Amplifier**, complete with valves, H.M.V. £5 speaker, cost £17, perfect; £6.—22, Craighall Ave., Levenshulme, Manchester. [4250]**ARMSTRONG Co. Have a Further Few Soiled but Genuine Brand New Radio Chassis for Disposal at Considerably Less Than Cost Price**, described hereunder.**ARMSTRONG 1937 9-stage Radio-gramophone Chassis**, covering 4 wavebands from 12.9 metres, circuit H.P. Pentode as radio frequency amplifier, tuned H.F. transformer coupled to hexode triode, detector oscillator, 2 band-pass coupled I.F. amplifier stages, double diode triode, detector and L.F. amplifier, push-pull output stage capable of handling 6 watts, highest grade components used throughout. "Airplane" multi ratio drive, all wavebands calibrated station names, tone control works on both radio and gramophone, provision for extension speaker, etc.**SEVERAL Chassis as Above**, brand new, but chassis slightly marked; price, complete with Marconi and Mullard valves, 9 gns.; an exceptional opportunity.**ARMSTRONG 1936 Colonial 7-valve All-wave Chassis**, two only, £6; complete with British valves.**ARMSTRONG 1936 Colonial 8-valve All-wave Push-pull Chassis**; two only, £7, complete with British valves.**ARMSTRONG 7-stage Superhet Radiogram Chassis**, 2 wavebands, complete with new Bin. Rola speaker; one only, 5 gns., complete with British valves.**ARMSTRONG Co. Will Willingly Send Above Chassis on 7 Days' Trial**, carriage and packing free.**ARMSTRONG MANUFACTURING Co., 100, King's Rd., Camden Town, N.W.1. [4242]**

No. 34.

Notes**on the Suppression of Electrical Interference with Broadcast Reception****LEGISLATION**

As suppression experts we have been constantly pointing out that a reasonable degree of suppression can be obtained at the noise source with inexpensive suppressors, whereas the cost of complete suppression at the source would be colossal. Similarly, if nothing is done at the source it would be expensive, and in some cases impossible for the listener to obtain complete silence at his end. We, therefore, are hopeful that legislation, when introduced, will compel a degree of suppression at the source, which will give listeners interference-free reception only if the listeners provide themselves with a reasonable anti-interference receiver installation.

On preparing for legislation our job, as suppressor makers, is therefore to be ready with every conceivable type of suppressor for use at the source, and to be ready for a great rise in demand for anti-interference aeriads, and set lead filters, to enable all listeners to reap the full benefit of this much-wanted legislation.

Generally speaking, two forms of interference annoy listeners—that which is conducted along the mains lead to the receiver and which is dealt with by type 300 mains filter in the set lead; and interference which reaches the aerial system by radiation and which must be dealt with by the removal of the aerial outside the field of interference. If an indoor aerial is in use a great improvement will generally result in the installation of an outdoor aerial, but in bad cases the down lead will pick up sufficient interference to cancel out any benefit, and it will be necessary to use a screened feeder. Except in rare cases the capacity losses of such an arrangement will be such that an "Eliminoise" system will be required. No anti-interference aerial can operate satisfactorily unless the active part of it is well outside the field of interference, say, 15 to 20 feet from other conductors (and remember a water gutter is a conductor). Also remember, no such system can cure that form of interference which is conducted to the receiver along the mains lead.

Where both conducted and radiated interference is present a mains filter, type 300, and an "Eliminoise" will be required. The mains filter is easy to plug in and the "Eliminoise" aerial is as easy to erect as an "L" type aerial, and is similar in appearance.

† Type 300 Mains Filter, for set lead, 10 to 2,000 metres, 21s. * "Eliminoise" (Trade Mark) Anti-interference Aerial. All broadcast bands 10 to 2,000 metres, 35s.

"C" type Shielded Cable, extra per yard, 10d.

Send for the book, "Interference Suppression," post free 1s. 2d., or for free copy of "The Eliminoise System" and other relative literature.

BELLING-LEE SUPPRESSION SERVICE**Belling & Lee Ltd.**
Cambridge Arterial Road,

Enfield, Middx.

Telephone: Enfield 3322.

PUBLIC ADDRESS EQUIPMENT SPECIAL Offer!!!

60 Watt Model for 6L6s, with microphone and gramophone independent inputs, and outputs for 4, 7½, 15 and 30 ohm speakers, consumption 150 watts, in ventilated steel carrying case; £24 only! complete with valves less two 6L6s.

8½ Gds. Complete—Vortexion portable 15-20 watt 4-stage amplifier, independent mike and pick-up inputs, outputs for 7½ and 15 ohm speakers, weight 25lb., 4 independent input model, £10.

HEAVY Duty 20 watt model, as fitted to dance halls and cinemas, etc.; £15, complete with valves.

WHY Not Call and Have a Demonstration.

VORTEXION, Ltd., 182, The Broadway, Wimbledon, S.W.19. Phone: Lib. 2814. [4254]

PARTRIDGE P.A. Manual, free to trade. See "Partridge Transformer" under "New Mains Equipment." [3487]

10 W. A.C. 3-stage 5-valve Amplifier, 200-240v., little used; £5/10.—Write, J. S. Burns, 23, Sisters Ave., London, S.W.11. [4219]

HARMONY HOUSE SOUND SERVICE, Southport.—Beam power amplifiers, 14 watts output; £13/10 (subject); send for lists. [0546]

AMPLIFIED Speech and Music for Fetes, sports meetings, etc., using our public-address mobile equipments, also smaller equipments for dinners, dances, conferences, etc.—Harmony House Sound Service, Southport. [0548]

ARMSTRONG Latest Coronation 30-watt Public Address Amplifier, incorporating 3 input circuits and self contained Fader system. Both microphone stages have a total gain of 97db. and are electron coupled. This apparatus is particularly suitable where large output is required.

TECHNICAL Details: 3-stage L.F. amplifier having 3 inputs; both microphone stages use L.F. triodes, which are electron coupled, the input impedance of both stages remaining constant; first input stage coupled to L.F. triode, which incorporates gramophone input circuit; the output stage is push-pull class A.B. with self bias, transformer coupled to preceding stage; power is obtained from a unit using 2 full wave rectifiers. The whole equipment constructed on 2 heavy pressed steel chassis; the finest British materials are used throughout; price, complete with 7 British valves, 16 gns., for 200-250 A.C. mains.

ARMSTRONGS, 100, King's Rd., Camden Town, N.W.1. Phone: Gulliver 3105. [4243]

USED SETS FOR SALE AND WANTED
W.W. MONODIAL

1936 Monodial, quality amplifier, with valves, whistle retractor, Hartley Turner twin diaphragm speaker, 1,250 ohms, Garrard autogram; what offer for whole or parts?—Rushton, 42, Broad Walk, Wilmslow. [4244]

QUALITY AMPLIFIER

SCOTT Sessions Q.A. Super £20 Receiver, demonstration perfect, in massive 4ft. burr walnut new cabinet, worth £25; 1937 (March) Rola G.12; £13; Enfield.—Box 1493, c/o Wireless World. [4236]

DYNATRON

DYNATRON 11-valve, in special cabinet, with Celestion tweeter and speaker, Garrard motor and pick-up, perfect; £30 or offer; would separate.—Fisher, 46, King St., Maidenhead. [4227]

G.E.C.

FINEST Bargain in the "Wireless World".—Nearly new 8-valve G.E.C., cost about £30, with £7 W.B. speaker, both in first-class condition; £7 the two; surplus to requirements, having purchased all-wave.—H. Roberts, Fron Rd., Connah's Quay, Chester. [4218]

NEW MAINS EQUIPMENT

V

V

VORTEXION Quality Transformers.

VORTEXION Supply the B.E.C. G.P.O. L.P.T.B., I.C.I., Borough Councils, etc. Why not you?

All Fitted Screened Primaries, and tapped 200-250v. with centre tapped filaments, guaranteed one year.

W.W. Q.A., 425-0-425v. 120-160 m.a., 4v. 5-10a., 4v. 2.5a., 4v. 1-2a., 4v. 1-2a., super shrouded model; 32/-

500-0-500v. 150 m.a., 4v. 4a., 4v. 2.5a., 4v. 2a., 4v. 2a., 4v. 2a., super shrouded model, 2.5% regulation, 35/-; open type, 32/-; 400 or 450v. same price.

350-0-350v. 120 m.a., 4v. 2-6a., 4v. 2-4a., 4v. 1a., 4v. 1a., super shrouded, 25/-; normal shrouded, 21/-; open type, 18/6.

350-0-350v. 75 m.a., 4v. 2-4a., 4v. 1-2a., shrouded, 18/-; open type, 16/.

250-0-250v. 60 m.a., 4v. 2-4a., 4v. 1-2a., shrouded, 15/-; open type, 12/6.

AUTO Transformers. 100-120 to 200-240v.; 80 watts 11/-, 120 watts 14/6, 200 watts 21/-, 500 watts 37/6.

CHOKES.—30h. 60 m.a., 7/6; 7-13h. 120 m.a., 12/6; 30h. 150 m.a., 15/-

OUTPUT Transformers.—4-10 watt W.W. Q.A., 21/-; 20 watt super shrouded, 30/-

VORTEXION, Ltd., 182, The Broadway, Wimbledon, London, S.W.19. (Telephone: Liberty 2814.) [3951]

TANTALUM for A.C. Chargers, H.T. and L.T.—Blackwell's Metallurgical Works, Ltd., Garston, Liverpool [3984]

M.R. SUPPLIES

are enlarging their well-known London premises and have limited stocks of the following high-class **PUBLIC ADDRESS** and **RADIO MATERIAL** for disposal at remarkably low prices. Every item guaranteed.

EARLY RESERVATION ESSENTIAL.

17 ONLY G.E.C. "OVERSEAS 7" RECEIVERS, A.C. 100/250 v. tuning from 11.5 to 555 metres, continuous switching. Fully delayed A.V.C., 3-watts undistorted output, large energised M/Coil speaker built in, single knob tuning. Completely modern 7-valve super-het. circuit giving remarkable results on the short-wave band. Brand new £24 model with seven new Osram valves, in makers' packing £8/15/- each. 50-page instruction and service manual with each.

4 ONLY G.E.C. RACK RADIO UNITS, A.C. 200/250 v. 5-valve laboratory-built super-het. Very sturdy construction, full-vision scale. All metal panel 14" by 19", depth 12". Brand new with new Osram Valves, £8/10/- each. Also 2 only 7-valve Super-hets., same size and construction, £9/10/- each.

3 ONLY G.E.C. RACK AMPLIFIERS, A.C. 200/250 v. for coupling to above radio units. Output 6-watts undistorted. Tone and volume controls, fitted milliammeter. Same panel dimensions, depth 7 1/2". Brand new with Osram valves, £8/10/- each.

2 ONLY TANNOY AMPLIFIERS, A.C. 200/250 v. Output 7-watts. With built-in playing desk (Garrard Motor, Marconi Pickup) and mike stage, in teak portable cabinet. Complete with all valves and separate large energised Cabinet Speaker, £11/10/- each.

3 ONLY WEBSTER AMPLIFIERS, 100/250 v. A.C. (with transformer). Push-pull output 15-watts. Energise 1,000 ohm speaker. Complete with six new valves, £7/10/- each.

14 ONLY G.E.C. 1564 MICROPHONE PRELIMINARY AMPLIFIERS suitable for use with any amplifier, energising carbon mike and giving very high gain. Thorough smoothing. Brand new with Osram MS4b valve, 4/6 each. Circuit diagram with each.

9 ONLY G.E.C. SUPER-CINEMA M/COIL SPEAKERS, 2,000 ohm field. Handle 20-watts. Weight (speaker only) 4 1/2 lbs. Brand new in massive oak cabinet. Response 50-7,500 c/s, £4/10/- each.

LAST FEW P.M. PROJECTOR HORN UNITS for P.A. 20-watt models by Vitavox, Truvox, F.I., etc. All maker re-conditional, £5/10/- each.

ALSO 6-VOLT 20-WATT DITTO, by Truvox, Vitavox, Racoon, etc., 3/6 each. 10 only Field Supply Units for

ALL GOODS CARRIAGE PAID U.K.

energising above 6-volt Horn Units from 200/250 v. A.C., Westinghouse Rectified and fully smoothed. In metal cabinet. Also suitable as 2-amp. chargers, 39/6 each.

15 ONLY GEN-E-MOTORS. The most compact and efficient motor generators made. Input 12-volt (a few 0-volt) Output 250 v. 50 m.a. Just right for car radio, etc., 32/6 each, or with filter, 47/6 each.

18 ONLY WRIGHT DE COSTER P.M. M/COIL SPEAKERS, 12" diaphragm, para-curve, multi-ratio transformer, 32/6 each.

10 ONLY A.C. MOTORS, one-quarter H.P. 200/250 v. Split-phase 50 cycle, 1,425 r.p.m., self-starting rep. induction, brand new, 49/6 each.

TIME SWITCHES, break 3-amps, on and off periods from 4 to 23 1/2 hours, 21/-.

ELECTRIC CLOCK MOVEMENTS, machine cut gears, slow rotor, drive up to 15" hands, dia. 2 1/2", 16/6.

NEW TUNAR BATTERY CHARGERS, charging up to 12 volts 5 amps. Ready for use, £6/10/- model for 97/6.

SLIDING RHEOSTATS, 40-watts, full range from .25 amp. (475 ohms) to 2.5 amps. (6-ohms) good action, 7/11. Also 225-watts, 1 amp. (225-ohms), 12/6.

EXCITER LAMP TRANSFORMERS 200/250 v. to 10 v. 7 1/2 amps, 16/6.

VOLTAGE CHANGING AUTO TRANSFORMERS, ironclad, complying with regulations. 200/250 to 100/120 and vice-versa, 75-watt 11/6, 120-watt 17/6.

STEP-DOWN TRANSFORMERS, 200/250 v. to 7, 11 and 15 v. for railways, chargers, etc., 9/6.

HEAVY DUTY OUTPUT TRANSFORMERS, exact "W.W." specification, 11 ratios from 11/1 to 75/1 with C.T. for P.P., weight 7 1/2 lbs., 28/-.

G.E.C. LINE TRANSFORMERS, heavy duty, for stepping up line impedance to avoid losses, 12/6 pair.

WESTON MILLIAMMETERS, model 301, 0-3 m.a., 0-50 m.a. or 0-200 m.a., either 25/-.

STANDARD POST OFFICE RESISTANCE BOXES, as new, £5/7/6.

LIST No. 1436 describes the range of popular M.R. Microphones, Portable Amplifiers, etc.

M.R. SUPPLIES,

11, NEW OXFORD STREET, LONDON, W.C.1. (Telephone: Holborn 7058)

GOOD as NEW!



When you specify a Gardners Radio Rewind you can be quite sure of three things: 1—That the rewound component will certainly be as "Good as New"; 2—That the repair will be done within two or three days; 3—That it will be guaranteed unreservedly as to quality, accuracy and reliability.

So when a transformer, choke, or speaker breaks down, take it to your usual Radio Dealer and ask him for a Gardners Radio Rewind. He will tell you exactly how much it will cost and in a day or so will have it ready for you—Good as New again.

★ DEALERS! Send now for price lists, free transport boxes, and addressed labels.

A GARDNERS RADIO Rewind is as good as a NEW Component!

GARDNERS RADIO LTD
Carbery Works W. Southbourne
BOURNEMOUTH



SPECIAL OFFER

SHOP-SOILED SUPPRESSORS at Irds List Price, fully up to correct working condition; V.2 Tunable Types, 11/8 net cash; Q.A.S. Tunable, 7/-; A.5 for 9 kcs, 8/-; Numerous Disc Chokes from .05 H. to 2 H., also Screened H.F. Chokes at Irds List. Cannot be repeated when sold. List Free. POSTLETHWAITE BROS., KINVER, STAFFS.

PETO-SCOTT

THE ONLY FIRM with 18 YEARS' EXPERIENCE supplying the specialised needs of the constructor

SHORT WAVE CONVERTER FOR A.C. MAINS

CONVERTER KIT 'A' All components to "Wireless World" Specification, with B.T.S. ready drilled chassis and aluminium panel, including all necessary formers, wire, screws, nuts, screwed rod, screens and brackets, but less valves and cabinet. Cash or C.O.D. Carriage Paid £4 15/3 or 12 monthly payments of 8/9. **8/9 DOWN**

POWER PACK KIT 'A' All components with B.T.S. Chassis, Mains Transformer and Choke, including all screws, nuts, etc., but less valves. Cash or C.O.D. Carriage Paid £2 6/3 or 12 monthly payments of 4/3. **4/3 DOWN**

COMPLETE KIT for CONVERTER and POWER PACK As detailed above, but including 2 specified valves, less cabinet. Cash £8:7:0 or 15/6 down or C.O.D.

Balance in 11 monthly payments 15/6 Ready-Built and Tested

B.T.S. COIL UNIT for the "Wireless World" Short Wave Converter Constructed exactly in accordance with "Wireless World" specified valves, using specified switches and ready-wound coils exact to specification. With trimmers. Ready for insertion in the S.W. Converter **30/- Post Paid**

B.T.S. STEEL CABINET For housing Converter only. Rigidly constructed 20 gauge steel cabinet of entirely new and unique design. Hinged lid, ready drilled back, fitted with ventilating louvers, base equipped with rubber feet. All metal work in stove enamelled black crackle finish. **18/6 Postfree**
A metal ventilated box for housing the Power Pack is also available. Prices on application.

FINISHED INSTRUMENT Peto-Scott Version

Assembled and tested by Peto-Scott technicians, employing B.T.S., Oylton, Bie and Peto-Scott components to exact values as specified by "Wireless World"; and complete with 2 valves, less cabinet. Cash or C.O.D. **£7:19:6** or **15/- DOWN** and 11 monthly payments 14/6
If B.T.S. Cabinet for Converter only required add 18/6 to cash price or 1/9 to deposit and each monthly payment.

All Postal Orders must be crossed and currency registered.
PETO-SCOTT Co., Ltd., Established 1919
77 (W.W.22), City Road, London, E.C.1.
62 (W.W.22), High Holborn, London, W.C.1.

NEW MAINS EQUIPMENT

PARTRIDGE Transformers, as supplied to B.B.C., Marconi's, G.E.C., Mullards, I.O.I., Tungsram, etc.
SPECIALS Despatched Within 48 Hours; all standard types from stock.

SPECIAL Quotations to Manufacturers for Lots of 6 Upwards, hand wound, individually tested, immediate delivery, rock bottom prices.

TELEVISION Transformers Insulated to 10,000v. A.C., expert knowledge of transmitting requirements (mains and modulation).

HIGH Fidelity (20 to 15,000 Cycles) Intervolve and Output Transformers a Speciality.

PARTRIDGE P.A. Manual Free to Trade Only; contents includes constructional amplifiers, notes on microphone, pre-amplifiers, lines, mixing impedance matching speakers, etc.

PARTRIDGE, N., B.Sc., A.M.I.E.E., King's Buildings, Dean Stanley St., London, S.W.1. Phone: Vic. 5035. [3717]

CABINETS

RADIOGRAM Cabinets, new designs, 30/- to £5/10; inspection invited or photos for selection sent on request.

TABLE Radio Cabinets, undrilled, 6/6 upwards.

SPEAKER Cabinets, 4/6 upwards.

MANUFACTURERS' Clearance.

BURGOVE "Fury" Radiogram Cabinets (undrilled), 34x22x16 1/2; 49/6.

K.B. De Luxe Walnut Cabinets, undrilled, chromium plated edges and speaker grille, 25in. wide, 14 1/4in. high, 10 1/2in. deep, 18/6; Console model, 42in. high, 21 1/2in. wide, 11 1/2in. deep, 39/6.

HALCYON Radiogram Cabinets (Reconditioned), 33x23x19, 35/-.

H.L. SMITH and Co., Ltd., 287-9, Edgware Rd., London, W.2. Tel.: Pad. 5891. [0485]

DYNAMOS, MOTORS, ETC.

ALL Types of Rotary Converters in Stock, new and second-hand.

WARD, 46, Farringdon St., London, E.C.4. Telephone: Holborn 9703. [0518]

A.C.-D.C. 1- and 3-phase Motors, all voltages; from 14/9; list free. Repair specialists.—Easco, 18w, Brixton Rd., S.W.9. [0455]

NEW LOUD-SPEAKERS

BAKER'S Quality Surplus Speakers.

HITHERTO Baker's Surplus Speakers Have Been Sold Through Agents; quality enthusiasts in search of a bargain can now obtain these speakers direct from our works. The following speakers are all brand new 1935-1936 models, and are offered at considerably under half list prices. If you are requiring Quality Reproduction at low cost, order one of the following exceptional bargains now. You will be amazed at the value obtained.

THE Auditorium Models are Fitted With Latest Triplo Cone, comprising main curved cone and bakelite and duralumin cones combined, giving wide and even frequency response resulting in quality reproduction of both speech and music.

39/6 Only, usual price £5.—Auditorium Permanent Magnet Speaker, with Alni magnet and die cast frame, large 12in. triple cone giving wide frequency range, complete with large 25 ratio transformer suitable for all outputs, including push-pull and Class B., etc.

59/6 Only, usual price £6.—Auditorium Electro-Magnet Speaker, 1,000, 1,250, 2,000 or 2,500 ohms field, exceptionally large magnet of high permeability steel giving enormous flux density, 2in. moving coil, large triple cone giving wide frequency range, complete with universal transformer, the ideal speaker for use with "Wireless World" and other quality amplifiers.

75/- Only, usual price £9.—As above, but for use on A.C. mains; complete with Westinghouse rectifier and full smoothing equipment.

24/- Only.—Permanent Magnet Speaker, Alni magnet, die cast frame, 10in. cone, Universal transformer.

15/6 Only.—Permanent Magnet Speaker, Alni magnet, 8in. cone, Universal transformer.

12/6 Only.—Permanent Magnet Speaker as above, with 7in. cone.

2/9 Only.—Brand new cabinets, 12x10x8

8/6 Only.—Electro-Magnet Speakers, with 8in. cone, 6,500 ohms field, Universal transformer.

ALL Baker Quality Surplus Speakers are Sold for Cash or C.O.D.

BAKER'S SELHURST RADIO, Ltd., The Pioneer Manufacturers of Moving Coil Speakers, 1925-1937, 75-77 Sussex Rd., South Croydon. (Croydon 3441.) [3892]

VAUXHALL.—Best quality speakers; see other column last week.—Vauxhall Utilities, 163a, Strand. [4245]

LOUD-SPEAKERS

SECOND-HAND, CLEARANCE, SURPLUS, ETC.

ROLA G12, 2,500, complete model, £2/15; Rethermel De Luxe tweeter, 15/-—Thorn, 127, Broadway, Cricklewood. [4217]

VAUXHALL.—All speakers previously advertised are standard lines, ready for immediate delivery.—Vauxhall Utilities, 163a, Strand. [4246]

19 37 New (Boxed) Set Bankrupt Stock Rola G12, 1,250 field, push-pull transformer; £2/10, carr. pd.—Spencer Radio, 318, Queen's Drive, Walton, Liverpool, 4. [4252]

VALVES

ANDERSON.

AMERICAN Valves, all makes, first grade only; 5/- each.

ANDERSON, 35, Lansdowne Rd., Walthamstow, E.17. Walthamstow 0827. [3351]

3/- Each.—6L6, 6K7, 6H6, 25Z6, 25A6; all other popular types American tubes.

RADIOGRAPHIC, Ltd., 66, Osborne St., Glasgow, C.1. [4038]

VALVES

"CHAMPION" American Valves (R.C.A. licensed), 69 various types stocked; write for list; special discount to trade dealers.

THE UNIVERSAL RADIO Co., 221, City Rd., London, E.C.1. [4026]

AMERICAN Valves, first grade, in all types; trade supplied.—Metropolitan Radio Service Co., 1021, Finchley Rd., N.W.11. Speedwell 3000. [0436]

ALL Types of American Valves in Stock of Raytheon, Sylvania, and Arcturus makes, at competitive prices, guaranteed for six months; send for full list; 350 ohms line cords, 2/8.

WARD, 46, Farrington St., London, E.C.4. Tel.: Holborn 9703. [0452]

NOTHING Better Available. Six months' guarantee, complete range of battery, A.O. mains, rectifiers, always in stock, 2 volt det., H.F., L.F., 2/3; Power, 2/9; screen grid pentode, H.F. pentode, 5/-; American types, six months' guarantee, 5/6 each, Nos. 18, 24A, 35, 42, 43, 45, 47, 56, 57, 58, 75, 77, 78, 80, 2A5, 2A6, 2A7, 6A7, 2B7, 6B7, 6C6, 6D6, 2525, 25Y5.—Write for other prices to Dulci Electrical Co., Devonshire Works, Duke's Av., Chiswick, London, W.4. [0501]

METERS, ETC.

AVO-MINOR, 25/-; Avo-Daptor, 10/-; perfect condition.—Burke, 19, Brimstage Rd., Liverpool, 4. [4232]

WESTON Microammeters, type E600, unused, 0-50 microamps, £2; 0-100 microamps, 35/-—Rieder, 21, Raylean Rd., Barnet. [4224]

TESTING EQUIPMENT

COSOR Oscillograph, unused, and as new; £25.—H. H. Sharland, 9, Thavies Inn, Holborn Circus. [4214]

NEW COMPONENTS

MICROPHONES.—Reisz or Lapel parts.—A. Hinderlich, 2, Bridge Rd., London, N.W.10. [4008]

"WIRELESS World" Specification Transverse Current Microphone Transformer, individually made, tested, 8/6; intervalve, output, mains types supplied.—Brown, 47, Pembroke Crescent, Hove. [4230]

COMPONENTS

SECOND-HAND, CLEARANCE, SURPLUS, ETC.

RADIO CLEARANCE, 63, High Holborn, W.C.1. Holborn 4631.

FINAL End of Season Clearance of High-Class Receivers and Components.

LISSEN A.C./D.C. Plus Rectifier Receiver, fitted in handsome walnut cabinet, clock face tuning, etc.; a really fine receiver; to clear £2/17/6.

LISSEN Ditto, but all wave (3 wavebands covered, short, medium and long); £4/19/6.

REGENTONE All-wave 4-valve A.C. Receiver, fitted in handsome walnut cabinet, circuit H.F. pentode, detector, pentode output, valve rectification, large type moving coil speaker; £4/12/6.

BUSH A.C.25, 4-valve band pass receiver, fitted in handsome walnut cabinet, a really up-to-the-minute job; to clear at 4 gns.

THE Following High-Class Surplus Stock are Offered.

POLAR 3-gang Straight Condenser, fully screened, top trimmers, 3, 0.0005 section, a handy sized job; to clear, 4/11.

PLESSEY Ditto; 4/3.

COSOR 2-gang, two 0.0005 sections, with separate vernier control, both main and vernier control operated from the panel; 5/6.

5-PIN Chassis or Baseboard Mounting Valve Holders; a really first-class job; 3d. each.

7-PIN Ditto; 7d. each.

PHILCO Valve Screens, one-piece type with separate base; 4d. each.

ENQUIRIES, 1½d. stamp if reply expected.

HOURS of Business, 9 a.m. to 7 p.m., Saturdays 9 a.m. to 1 p.m.

ALL Orders 5/- or Over, post free. Orders under 5/- must be accompanied by a reasonable amount for postage.

C.O.D. Orders Under 5/- Cannot be Accepted.

ORDERS from Ireland and Special Parts of Scotland are Subject to Certain Increased Rates of Postage, and customers are advised to apply for details of postage before ordering.

RADIO Clearance, 63, High Holborn, W.C.1. Holborn 4631. [4256]

PREMIER SUPPLY STORES.

PLEASE See Our Displayed Advertisement on this page. [0488]

RYALL'S RADIO, 280, High Holborn, London, W.C.1. offer new goods at knock-out prices.

AMPLIFIERS, with 6-watt output, 3-stage, for A.C. 200-250v., splendid chassis, Ferranti transformer, complete with 5 valves; 50/-.

3-GANG Condensers, "straight type" 0005, die cast frames, small size ex Cosor, fully screened, trimmers top, 2/9; Plessey ditto, large or small piano type, 4/6.

CLYDON Trimmers, sizes 50 mm., 70 mm., 140 mm.; 4d. each, or 2/9 dozen.

CHASSIS, 3v., with rectifier, Varley iron core coils, Plessey twin gang, complete with J.B. dial, station names, valves and B. & A. speaker; 50/-.

T.C.C. Electrolytics, tubular can type, dry, 16x8 mfd. 450v., 1/7; 4x4 ditto, post extra on this line.

N.S.F. 0.1 Tubular Non-inductive 1,000v. Test Condensers, 2/6 dozen, tag ends; 0.01 ditto N.S.F. 25x25 mfd., six for 3/, tubular, wire ends.

PAIRS Matched Ferranti Screened Coils, aerial and H.F., with reaction, sensitive and selective; 2/6 per pair, chassis type.

FERRANTI Mains Transformers, as used in their own commercial receivers, 350-0-350v., 70 m.a., 4v. 2½a., 4v. 4-5a., C.T. input 200-250 v., brand new; 6/6 each. [4187]

PREMIER SUPPLY STORES

Offer the following Set Manufacturers' Brand New Surplus Goods at a Fraction of the Original Cost; all goods guaranteed perfect; carr. paid over 5/-; under 5/- postage 6d. extra. Orders under 5/- cannot be sent C.O.D.

JUBILEE WORKS, 167 LOWER CLAPTON RD., LONDON, E.5

CALLERS, AS USUAL, TO 165 & 165A, FLEET ST., E.C.4 (Next door to Auderton's Hotel). Central 2833. New Branch:—50, HIGH STREET, CLAPHAM, S.W.4 (Macaulay 2381).

Have you had our GIANT ILLUSTRATED CATALOGUE AND VALVE LIST? Send 4d. in STAMPS FOR THIS BARGAIN LIST.

MAINS VALVES, famous Europa 4 v. A.C. types, 4/6 each. H.L., S.G., Var.-Mu-S.G., H.F.-Pens., Var.-Mu-H.F. Pens. 1- and 4-watt A.C. directly heated output Pentodes. A.C./D.C. types. 20-watt 18 amp. S.G., Var.-Mu-S.G., H., H.L., Power, Pen, H.F. Pen and V.-Mu-H.F. Pen. Following types all 5/6 each. Full-wave rectifiers, 350 v. 120 m.a. and 500 v. 120 m.a. 2½-watt indirectly-heated Pentodes, Octode Frequency Changers.

BATTERY VALVES, 2 volts, H.F., L.F., 2/3. Power, Super-Power, 2/9. S.G., Var.-Mu-S.G., 4- or 5-pin Pentodes, H.F. Pens., V.-Mu-H.F. Pens., 5/-, Class B, 5/-.

AMERICAN VALVES. Genuine American HYTRON and TRIAD first-grade Valves. 3 months' guarantee. All types in stock, 5/6 each. 210 and 250, 8/6 each. New Metal-Glass Valves, all types, 6/6 each. Genuine American DUOTRON Valves, all types, 3/6 each. Valve holders for all above types, 6d. each. Octal bases, 9d. each.

SHORT-WAVE COILS, 4- and 6-pin types. 13-26, 22-47, 41-94, 78-170 metres, 1/9 each, with circuit. Special set of 3-4-Pin S.W. Coils, 14-150 metres, 4/- set, with circuit. Premier 4-pin 3-band S.W. Coil, 11-25, 10-48, 38-86 metres. Suitable any type circuit, 2/6. COIL FORMERS, in finest plastic material, 1½in. low-loss ribbed, 4- or 6-pin, 1/- each.

SUPER CERAMIC CONDENSERS, S.L.F., .00016, .0001, 2/9 each; double-spaced, .00005, .00025, .00015, 3/- each. All brass with integral slow motion, .00015 tuning, 3/9; .00015 reaction, 2/9.

CERAMIC S.W. VALVE HOLDERS, 4-, 5- or 7-pin. Chassis types, 6d.; B.B. type, 8d. GLASS AERIAL INSULATORS, 4d. each. BEEHIVE STAND-OFF, 6d. each. SCREENED FLEX, single, 3d. yd.; twin, 4d. yd.

H.F. CHOKES, S.W., 10-200 metres, 9d.

ELECTROLYTICS. U.S.A., 4 or 8 mfd. 530 v. peak, 1/9 each. Dubilier, 4 or 8 mfd. 500 v., 3/-; 50 mfd. 50 v., 1/9; 10 mfd. 50 v., 6d.; 25 mfd. 25 v., 1/-; T.C.C. 8 mfd. 650 v., 4/-; 15 mfd. 50 or 100 v., 1/-; 50 mfd. 12 v., 1/-.

Paper Condensers. W.E., 250 v. working 4 mf., 2/-; 2 mf. 1/-; 1 mf. 6d.; 350 v. working 4 mf., 2/6; 2 mf., 1/6. Dubilier 500 v. working 4 mf., 4/-; 800 v. 4 mf., 6/-.

COSMOCORD PICK-UPS, with tonearm and volume control, 10/6 each. PICK-UP HEADS only, 4/6 each.

PREMIER MAINS TRANSFORMERS, wire-end type with screened primaries, tapped 200-250 v. Centre-tapped Filaments. Guaranteed one year. H.T. 8 & 9 or H.T. 10 with 4 v. 4 a. C.T. and 4 v. 1 a. C.T., 8/6. 250-250 v. 60 m.a., or 300-300 v. 60 m.a., 4 v. 1 a., 4 v. 2 a., and 4 v. 4 a., all C.T., 10/6. Any of these transformers with engraved panel and N.P. terminals, 1/6 extra. 500-500 v. 150 m.a., 4 v. 2-3 a., 4 v. 2-3 a., 4 v. 3-3 a., 4 v. 3-4 a., all C.T., 17/6. Super Model, 19/6. AUTO TRANSFORMERS, step up or down, 60 watts, 7/6; 100 watts, 10/-. SMOOTHING CHOKES, 25 m.a., 2/9; 40 m.a., 4/-; 60 m.a., 5/6; 150 m.a., 10/6. 2,500 ohms 60 m.a. Speaker Replacement Chokes, 5/6.

SPECIAL OFFER OF PHILIPS MAINS TRANSFORMERS. 250-250 v. or 300-300 v. 80 m.a., 4 v. 5 a. C.T. & 4 v. 1 a., 6/11.

LARGER MODEL WITH TAPPED PRIMARY, 100-250 v., 450-450 v. 150 m.a., 4 v. 4 a. C.T., 4 v. 4 a. and 4 v. 3 a. and 500-500 v. 100 m.a., 4 v. 4 a. C.T., 4 v. 4 a. and 4 v. 3 a., 12/6. LIMITED NUMBER ONLY.

MILLIAMMETERS, moving-iron, flush 2½in., all ranges from 0-10 m.a., 5/9. Visual tuning, 6 or 12 m.a., 5/9. Moving-coil meters, 2½in. 0-1 m.a., 18/6; 3½in. 0-1 m.a., 22/6. Multipliers, 1/- each. Ampermeters, 0-1, 3, 5, 10 or 20 a., 5/9.

TELSEN Multi-meters, 30 and 300 m.a., 8, 16 and 240 v., 8/6 each. Reads A.C. and D.C.

TRANSFORMERS, latest type Telsen R.G.4 (list 12/0), 2/9. Lissen Hypermik Q.P.P. (list 12/0), 3/6.

OUTPUT TRANSFORMERS for Power or Pentode, 2/6; Multi-Ratio, 4/6; Push-Pull Input Transformers, by prominent manufacturer, 4/6 each.

PREMIER L.T. CHARGER KITS for A.C. mains, including Westinghouse Rectifiers and Tapped Mains Transformers; 8 volts at ½ amp., 14/6; 8 volts 1 a., 17/6; 15 volts 1 a., 19/-; 8 volts 2 a., 29/6.

TELSAN iron-cored screened coils, W.349, 4/- each. Electric SOLDERING IRONS, 200-250 v., A.C./D.C., 2/3.

NEW 1937 1-VALVE SHORT-WAVE RECEIVER OR ADAPTOR KIT, 13 to 86 metres without coil changing. Complete Kit and Circuit, 12/6. VALVE GIVEN FREE!

DE LUXE MODEL 14 to 150 metres, complete Kit with Chassis, 4 Coils and all parts, 17/6. 1937 SUPERHET CONVERTER KIT, 13/6.

DE LUXE MODEL, 18/6. S.W. SUPERHET CONVERTER KIT, for A.C. Mains Receivers, 20/-; A.C. Valve given FREE!

NEW 1937 2-VALVE S.W. KIT, 13 to 86 metres without coil changing. Complete Kit and Circuit, 19/6. VALVES GIVEN FREE. DE LUXE MODEL, 14 to 150 metres, complete Kit and Chassis, 4 Coils and all parts, 25/-; VALVES GIVEN FREE.

3-VALVE S.W. KIT, S.G. Det. and Pen., 32/-; VALVES GIVEN FREE!

BAND-PASS TUNING PACK, comprising set of 3 Telsen iron-cored coils with switching, mounted on steel chassis with 3-gang condenser, illuminated disc-drive and 4 valve holders, 25/- the lot. All Mains or Battery circuit, FREE!

SPECIAL OFFER. LISSEN TWO-GANG SCREENED ALL-WAVE COILS, 12 to 2,000 metres, complete with switching and wiring diagram, 6/11 per set.

3 VALVE BAND-PASS KIT, 200-2,000 metres. Complete kit of parts, including chassis, all components, valves, M.C. speaker and wiring diagram. Battery Model, 50/-; A.C. Mains Model, 70/-.

MAGNAVOX. Mains energised M.C. Speakers. '154', 7in. cone, 2,500 ohms, 12/6; '152', 7in. cone, 2,500 ohms, 17/6; '152 Magna', 8in. cone, 2,500 ohms, 37/6. Magnavox P.M.s.—'254', 7in. cone, 16/6; '252', 8in. cone, 22/6. Reliable P.M.s., 10/6. TELSEN P.M.s. with 10 ratio Transformers, 12/6. ROLA latest type P.M.s., 15/-.

GOODMANS' 8in. mains energised 1,000 ohms field, 10/6 each. Jensen P.M.s., 10/6. B.T.H. ENERGISED MOVING COIL, 10½in. diam., 1,650 ohms field. Power or Pentode Transformer. (State which.) SPECIAL LINE at 14/6.

Potentiometers by well-known makers. All values up to 1 meg., 2/-; with switch, 2/6. GRAMOPHONE MOTORS. Collaro Gramophone Unit consisting of A.C. motor, 100-250 v. high quality pick-up and volume control, 45/-; Collaro motor only, 30/-; Collaro Universal Gramophone Motor, 100-250 v. A.C./D.C., with high quality pick-up and volume control, 67/6; Collaro Universal Motor only, 49/6; Edison Bell double-spring motors, including turntable and all fittings, 15/-; Cosmocord Gramo. unit, comprising A.C. motor pick-up and volume control (list 55/-), 35/9.

TUBULAR CONDENSERS, non-inductive, all values up to .5 mfd., 6d. each.

Wire-end RESISTORS, any value, 1 watt, 6d.; 4 watts, 1/-; 8 watts, 1/6; 15 watts, 2/-; 25 watts, 2/6 each.

Reliable MORSE KEYS with Morse Code engraved on bakelite base, 2/- each.

Bakelite case BUZZERS, 1/6; Walnut case, "Loud-tone," 2/6 each.

Super Quality lightweight HEADPHONES, 3/9 pair.

UTILITY 2-GANG MICA DIELECTRIC CONDENSERS (2 x .0005) with Uniknob Trimmers and disc drive, 3/6.

POLA STAR 3-GANG (3 x .005) with Trimmers, fully screened, 5/6.

PREMIER FILAMENT TRANSFORMERS, 4 v. 3 a., C.T., 7/6; 4 v. 5 a., C.T., 8/6; 5 v. 3 a., 7/6; 6.3 v. 3 a., 7/6; 7.5 v. 3 a., 7/6; 2.5 v. 8 a., 8/6.

THE MOTOR CYCLE
The Motor Cyclist's Newspaper
EVERY THURSDAY—3d.
Publishers: ILIFFE & SONS LTD., Dorset House, Stamford Street, London, S.E.1 w.w.15

TANNOY
THE SOUND PEOPLE
GUY R. FOUNTAIN LTD.
FOR ALL SOUND AMPLIFYING EQUIPMENT
CANTERBURY GROVE, WEST NORWOOD, LONDON, S.E.27. Phone: Str. 4122 (6 lines).

WEARITE ALL-WAVE OSCILLATOR UNIT
Covers all wavelengths from 15 M. to 3,000 M. in 7 ranges (harmonics not used).
MODULATION. May be switched off and external modulation used when required.
SHIELDING. Minimum leakage, no appreciable energy reaches the set.
STABILITY. Calibration permanent for all variables.
Price £7.15.0
Free booklet on returning this announcement to:
WRIGHT & WEAIRE, LTD.,
740, High Road, Tottenham, LONDON, N.17.

COMPONENTS—SECOND-HAND, CLEARANCE, SURPLUS, ETC.

V A U X H A L L .
V A U X H A L L.—Polar Midget 3-gang condenser, straight or superhet, 8/9; Polar full vision, horizontal or accurate dial and drives, 5/-.
V A U X H A L L.—J.B. drives with station-named scale, latest type, complete, 5/6; T.C.C. tubular, 0.25 mid., 9d.
V A U X H A L L.—Flat, sheet aluminium, hard rolled, 18 gauge, 12in.x12in., 3/-; 18x18, 5/6; other sizes pro rata.
V A U X H A L L.—Hivac, Tangram valves, full range; full discounts allowed from new prices.
V A U X H A L L.—Polar station-named scales, for horizontal dials, latest settings; 1/9 each.
V A U X H A L L.—Polar 2-gang condenser, 6/8; Colvern twin-gang iron cored coils, on base with switch, 20/-.
V A U X H A L L.—Colvern coils, G1, G2, G3, or G1, G2, and G2, superhet type, 30/-; Colpaks, £2/4; Polar drives, 5/-.
V A U X H A L L.—Iron-cored coils, 3-gang, on base, with circuits, 17/-; B.T.H. Minor pick-ups, 13/3.
V A U X H A L L.—All-wave tuning pack, 16.5 to 52 metres, medium and long waves; £87/6.
V A U X H A L L.—Heavyber low frequency smoothing choke, 10 henrys, 120 m.a., fully shrouded; 11/6.
V A U X H A L L.—Set manufacturers' surplus skeleton type Westinghouse rectifiers, H.T.8, 8/6; H.T.9, 9/-; H.T.10, 10/-; fixing brackets free.
V A U X H A L L.—T.C.C. electrolytic condensers, 8 mid. and 4 mid., 550 volt, 3/-; 500 volt, 2/6; 450 volt, 2/5.
V A U X H A L L.—T.C.C. condensers, tubular, non-inductive, 0.1 6d.; 50 mid., 50v. working, 1/6; 50 mid., 12v., 1/3; 0.05 6d.; 0.002, 0.0002, 0.001, 0.0001, 4d. each.
V A U X H A L L.—T.C.C. mica, 0.002, 2,000 volt test, 1/-; 0.0001, 4d.; 0.001, 1/-; 1 mid. Mansbridge, 1/3.
V A U X H A L L.—Resistances by well-known manufacturers, 1-watt type, 6d. each; all values.
V A U X H A L L.—Centre tapped iron cored I.F. transformers, bases, terminals, 110 k/c.; 6/6, guaranteed.
V A U X H A L L.—Volume controls, Erie, Colvern, Centralab, 2/-; with switch, 3/-; all values, from 2,000 to 2 meg.
V A U X H A L L.—Pushback wire, four colours, 6 yds. 6d.; 6B.A. screws or nuts, 4d. dozen.
V A U X H A L L.—T.C.C. 200 mid. 10v. dry, 2/6; 8 mid., wet, 450v. working, 3/3; Westectors, WX6, 4/-.
V A U X H A L L.—Colaro A.C. electric motors, boxed, 25/6; similar model, complete pick-up and volume control, 41/6; Universal motors, 47/6.
V A U X H A L L.—Clx valve holders, terminals, 7-pin, 9d.; 5-pin, 7d.; 9-pin, ordinary, 9d.; baseboard, 4-5-pin, 6d.
V A U X H A L L.—Post paid 2/6 or over, or cash on delivery 5/- minimum.
V A U X H A L L. UTILITIES, 163a, Strand, W.C.2, over Denny's, the Booksellers, Temple Bar 9338. Send postcard for lists free. [4247]

S O U T H E R N R A D I O ' S Wireless Bargains; all goods guaranteed and sent post paid.
R E C E I V E R S.—Vidor 3-valve battery portable receivers, complete with 3 Osram valves, special Vidor long life batteries and accumulator, moving coil speaker, brand new, in sealed cartons; £31/17/6.
L U C I L L E 5-valve American Midget Sets, complete with 5 valves, moving coil speaker, ready for use on any mains, 100-250 volts A.C./D.C., long and medium waves; £3/15, new, in sealed cartons.
R E C O R D C H A N G E R S.—Garrard Model R.C.4, plays automatically and changes eight 10in. or 12in. records of any kind, new, in sealed cartons; £6.
G R A M O P H O N E M O T O R S.—Collaro electric radiogram units, for A.C. or D.C. mains, 100-250 volts, fully auto stop, complete with pick-ups, can be used on any mains, brand new, in sealed cartons; 57/-; Collaro spring gramophone motors, with 10in. turntable, complete with all accessories, 11/-; all Collaro motors are brand new, in sealed cartons.
S P E A K E R S.—Celestion Soundex, permanent magnet, 10/-; Telsen permanent magnet, with 10-ratio transformer, to suit any receiver, 12/6; Telsen loud speaker units, 2/6; all brand new and boxed.
C O I L S.—Telsen iron core W349 (Midget size), 4/-; type W478 (twin), 9/- pair; type W477 (triple), 16/- per set; type W476 (triple superhet, selector and oscillator), 16/- per set; Telsen short wave coils, matched set of three, 4-pin bases, 12-26, 22-47, 41-94 metres, 5/- per set; Telsen dual range H.F. transformer and aerial coils, type W154, 3/- each; all ganged coils complete on base with switch; Telsen I.F. transformer coils, 110 k.c., 5/-; Telsen dual range coils, with aerial series condenser incorporated, type W76, 4/-; Telsen aerial condensers, with shorting switch, 2/-; all Telsen components brand new, in sealed cartons.
A M E R I C A N V A L V E S.—A full range of valves for all American receivers; 6/- each.
M I S C E L L A N E O U S B A R G A I N S.—All brand new, in original sealed cartons; Telsen A.C./D.C. multi-meters, test anything, radio or electrical, 8/6; Telsen 2-range voltmeters, 3/-; 3-range meters, including milliamps, 4/-; Ace (P.O.) microphones, with transformer, ready for use with any receiver, 4/6; Bell transformers, 200-250 volts input, 3, 5, or 8 volts output, 3/6; Morse signal units, incorporating buzzer, tapper and flash, with international code, complete with batteries and bulb, 3/9 each; lightweight headphones, double-pole, 4,000 ohms each earpiece, 3/- pair.
R E G E N T O N E E l l m i n a t o r s . A . C . 200-250 volts, type W5a, with trickle charger; 37/6.
S O U T H E R N R A D I O .—Branches at 271-275, High Rd., Willenden Green, N.W.10; 46, Lisle St., London, W.C.2. All mail orders to 323, Euston Rd., London, N.W.1.
S O U T H E R N R A D I O , 323, Euston Rd., London, N.W.1 (near Warren St. Tube). Phone: Euston 3775. [4192]

"FINALITY"

"I have waited four years to obtain reproduction such as I desired, having listened to demonstrations of nearly every make of commercial set and come away despondent. After listening to Elgar's First Symphony, played by the London Philharmonic Orchestra, conducted by Sir Thomas Beecham on Thursday evening, I heartily endorse your claim for an almost straight line performance. The reproduction did full credit and justice to the genius conducting the orchestra."

The above is an extract from a testimonial recently received from one of our many musical critic enthusiasts. This Gentleman commissioned us to convert his most excellent acoustic Gramophone into an up-to-date Radiogram.

May we respectfully suggest before YOU scrap that expensive Gramophone which is no longer up-to-date, WHY NOT get in touch with us?



ELECTRADIX BARGAINS

TELEPHONES for Office, House, Works, Garage and Field at Bargain Prices. Wall or table. Singles, pairs, or in sets with 10, 20, 30, 100 or 250-volt switchboards. Single Wall Set 15/-. Coronation Fete Portable Signal phones in leather case, useful for P.A. jobs. Headphones from 2/9.



HOME RECORDING within the reach of all. THE FEIGH RECORDER fits any Radiogram and is positive drive by worm gear and rack. No pulleys. The Recording Stylus is tracked across blank at the exact grooving spiral. Price complete, as illustration, with Tone Arm and cutter with real diamond 37/6. Gear only, 21/6. Discs, 4/- doz.

EIGHT AUTO TRANSFORMERS 150 watts. Test Bench model for any input or output 40v. to 300v. 19 taps. Two panels with 11 stud switch, 45/- each. NEW HUMPHREY TYPE MAGNETIC CHUCK 18" x 6" for 220/250v. D.C. cost £30. Westinghouse Rectifier for use on A.C. mains; cheap. NEW Large Triple-pole Iron-clad Vincent Switch and Fuses 500 v., 100 amps, 52/6. One D.P. Iron-clad Switch, 500 v., 200 amps. Vincent, 35/-, and a ditto, 60 amps, 15/6. CORONATION LAMPS, 25 v., 80 v., 115 v., and 220 v., 5/- dozen. 1,000 Porcelain Ceiling Roses with Ramie Junction Connectors, 5/- doz.

CORONATION Fountain Electric Pumps, for A.C. or D.C. mains. Centrifugal, all-bronze pump, 3ft. lift, 120 gals. per hour. For fct. fountain, etc. With 50 yds. twin rubber cable and iron-clad D.P. switch, 67/7. Larger pumps quoted for. NEW RECORD CIRCUIT BREAKERS, 600 v. 800 amps. S.P. with overload trip, 60/-. G.E.C. Triple-pole A.C. Breaker, 415 v. 50 amps. with 3 overloads and a no-volt trip, 70/-, 10 amp. enclosed Circuit Breakers with magnetic blowout, 9/6 each. Contactors and Min. Auto cheap. New Whitworth stocks and dies, in case, 1" to 3", full set, 42/6. Engine Indicators, Dobbie McLnnes & Elliott, in case, with 4 springs, 55/-; Bell Pulvo Workshop Vacuum Cleaner or Dust Extractor on trolley with 2 h.p. motor, 28/10/0.

8 MOV. COIL SWITCH-BOARD AMMETERS, 61" dial, 250 amps. and 350 amps., by J. & P., etc., 22/8 each to clear. Electric Air Compressors, various sizes from 1/2 cub. ft. to 4 cub. ft. per min. Blowers and Air Exhausters. Kindly state wants and ask for our Surplus Stock List. Send for Radio-Electrical-Scientific Illus. List "W" Free. ELECTRADIX RADIOS 218, UPPER THAMES STREET, LONDON, E.C.4 Telephone: Central 4611

COMPONENTS—SECOND-HAND, CLEARANCE, SURPLUS, ETC.

S T A N D A R D R A D I O S U P P L I E S , 1, Dantzic St., Manchester. Note our very low prices.
R E C E I V E R S . 1937 Ferranti Nova AC superhet, all wave 7-stage, brand new, sealed cartons, 12½ gns. list, 8 gns.
G R A M O P H O N E M O T O R S . Genuine Garrard 202 AC7 unit, comprising AC motor and pickup, list 4 gns. £2.
V A L V E S . famous Europa AC types, HL, SG, VMSG. AC Pen. 5-pin, HFFen, VMHFFen, FW Rectifiers 300v. all at 4/-. At 5/3 each, FC4 type, Pen4VD type, FW350/120 m.a., at 6/3 PM24M type. Also full range of Hivac Valves at full trade discounts.
A M E R I C A N V A L V E S , No. 1 makes in most numbers 5/-. Good second quality tubes at 3/-.
C O I L S . Telsen Iron Core W349 (midget size) 3/9; W478 (twin) 8/6; W477 (triple) 15/-; W476 15/-; I.F. Transformers W482 4/9; AC Trickle Charger 2 volts at 1½ amp 11/6.
T E L S E N A C / D C Multimeter 8/-; 3-range pocket 4/-; 1 Tubular condensers, 2/6 dozen.
A L L are Telsen 1937 components, brand new, sealed cartons. Send stamp for quotations for any items you may require.
A L L Orders Value 5/- Post Free; under 5/- postage extra; no c.o.d. orders under 5/-.
S T A N D A R D R A D I O S U P P L I E S . Every article sold is guaranteed. 1, Dantzic St., Manchester, 4. [4234]
O L I V E R S Offer Erie 1-watt Colour Coded Resistances, all values, 3½d. each, 3/- dozen, 2/6 dozen in 3 dozen lots.
A L U M I N I U M Chassis, 16in.x10in.x3in., 18 gauge, un-drilled, 5/3; 16 gauge, 7/6; quotations for special sizes upon request.
C E N T R A L A B Volume Controls, all values, with switch, 2/- each; chassis mounting valve holders, 5-pin 2½d. each, 7-pin 3½d.
M E T A L Case Electrolytics, Dubilier 8mid. 2/7; B.I. and T.C.C. 8mid., 2/4; 4mid., 2/1; T.C.C. tubular 1mid., 1/-; 50mid., 50v., 1/6.
B . I . T . C . C . Hunt's Cardboard Case Condensers, 4mid. 1/6, 8mid. 1/9, 4mid.-4mid. 2/-, 8mid.-8mid. 2/9.
A L L Types Non-ring Valves in Stock, and American replacements; lists and full discount upon request.
O L I V E R S , 676, Christchurch Rd., Boscombe, Hants. All enquiries invited. Orders under 5/6 postage extra. [4240]
H I G H - G R A D E Second-hand Instruments, P.O. boxes, reflecting galvanometers, wire, etc.—Box 1495, c/o The Wireless World. [4237]
M A I N S R A D I O D E V E L O P M E N T C o . Offer Several phone Tudor 4046; carriage paid; call mornings.
M A G N U M Fully Screened Three-wave Band Superhet. Coils, and I.F. transformers, surplus to set maker; latest type grey cellulose cans, trimmers on all wave bands, 15-52, 190-560, 800-2,200 metres; aerial (for pre H.F.), H.F. and oscillator (465 k/c.); three coils, two 465 k/c. I.F.'s, and three-gang Yaxley type switching; complete kit, with circuit, 25/-; without I.F. transformers, 17/6.
E R I E Surplus Quarter Watt Resistors, two each of six good sizes, our choice, 1/- dozen; colour coded, wire ends.
S A T O R Metal Cased Condensers, 400 volt working, 1 mid., 7½d.; 2 mid., 10d.; 4 mid., 1/8; Formo tag condensers .0001 to .002 mid., 1½d. each.
L O T U S Screened Iron Cored H.F. Chokes, boxed, 1/-; Wearite H.F. chokes, 6d.; Telsen binocular, 1/-.
C E N T R A L A B 500,000 Ohms Unused Potentiometers, 1/-; any size, with or without switch, 2/3; Rotorohm 10,000 ohms with switch, 1/6.
T U B U L A R Condensers, very best make, wire ends, 400 volt working, .0001-.0002 mid., 3d.; .005-.05 mid., 5d.; .25, 5 mid., 7d.; special offer .1 mid., 450 volt working, 5d.
R E S I S T O R S , absolutely finest make, one watt, wire end, colour coded, unused, 50 ohms, to 5 megohms, any size, your choice, 3½d., 2/9 dozen; two watt, any size, 6d.
C L I X Latest Unused Chassis V-holders, 4-pin, 1½d.; 5-pin, 2½d.; 7-pin, 4d.; 9-pin, 6d.; chassis, grey cellulose metal; three-valve, 12½x6½x3in., 1/-.
P Y E . 20h. 120 m/a boxed L.F. chokes, 4/6; Steatite S.W. condensers, 0.00016 mid., boxed, 1/6.
R E D U C T I O N of B.I.O 8 mid., 550 v. metal can elects., 2/3; ten other sizes on list.
M A I N S R A D I O D E V E L O P M E N T C o . 4-6, Muswell Hill Rd., N.6, London. All goods unused. [4131]
H E A D P H O N E S , guaranteed, Brown, Ericsson, G.E.C., Sterling, Siemens, B.T.H., Nesper, etc., 2,000 ohms, 2/6; 4,000 ohms, 5/-; postage 6d.
S P E C I A L . Ericsson, 4,000 ohms, as new, 7/6; Telsen, adjustable, lightweight, 2,000, 4,000 ohms, 7/6.
C R Y S T A L S c t s .—Burne-Jones, complete, guaranteed, 5/6; ditto, double circuit, 8/-; sensitive permanent detectors, 1/6; crystal detectors, complete parts, 1/-; crystal with whisker 6d., postage 1½d.—Post Radio, 183, Caledonia Rd., London, N.1. [4171]
E X P E R I M E N T E R S ' Surplus.—Ferranti transformers, —Austin, 33, Fitzroy Rd., Tankerton. [4228]
M A G N A V O X "Duode," 25,000 ohms, nearest £3/5; Rothermel power tweeter, 12/6; O.P.M.3, B.I. 10/- each; A.P.3s, 5/-; B.T.H. "Minor" pick-up, 10/-; Craig, 3, Poplar Grove, Cleethorpes. [4226]
S E R V I C E Engineers; Midland manufacturer has quantity of spares for W.W. quality amplifier, etc., resistors, transformers, condensers, chassis, etc., to clear at under half list; details for stamp.—BM/NMLG, W.C.1. [4231]
G R A M O P H O N E Attachments for Radio.—Electric motors, 25/-; pick-ups, 9/6; portable gramophones, 12/-; spring motors, 4/6, dozen 36/-, 100 £12/10, 1,000 £100; walnut pedestal Anexagram, £5; soundboxes, tone arms, horns, cabinets, needles, gears, springs, accessories cheapest; quantity buyers obtain lower prices; catalogue free.—Regentworld, 120, Old St., London, E.C.1. [4213]

REPAIRS AND SERVICE

GRAHAM'S
GRAHAM'S Radio, Repair and Rewinding Service; 24 hours' service guaranteed.—See below.
ALL Moving Iron Loud Speakers, L.F. transformers, or pick-ups, from 2/6, output transformers from 4/-; postage extra; mains transformers, moving coils, electric clocks quoted, trade discounts.—**Graham's Repairs**, 194-Tolworth Rise, Kingston By-pass, Surrey. Phone: Derwent 2060. [4141]

DISTAVOX SERVICE.
GUARANTEED Service.—All makes of English and American receivers; quotation by return.
REWINDING—Mains, L.F. and output, transformers, speakers, headphones, etc.; keenest terms for contracts.
DISTAVOX RADIO SERVICE Co., 119, Bunhill Row, London, E.C.1. Phone: National 8589. [4142]

"**SERVICE WITH A SMILE.**"
HENRY FORD RADIO, Ltd.—American valves, components, spares, line cords; leading trade repairers; send us your American and British receivers.—**Electronic House**, 22, Howland St., Tottenham Court Rd., W.1, Museum 5675. [4034]

METROPOLITAN RADIO SERVICE Co., for Guaranteed Repairs to American (Midget and Standard and British Receivers).
CLARION and Majestic Service Depot.—L.F. and mains transformers rewound. American valves and parts; trade supplied.—**Metropolitan Radio Service Co.**, 1021, Finchley Rd., London, N.W.11. Speedwell 3000. [4035]

REPAIRS, rewinds, and construction, any size transformers, chokes, etc., to trade.—**Felelectric**, Garden St., Sheffield, 1. [3915]
FOR Unusually Good Rewinding of Transformers, chokes, speakers, etc.; trade only.—**Gardners Radio, Ltd.**, West Southbourne, Bournemouth. [0551]

OUR Technical Department is at your Service.—**Air King Radio**, 115, Shaftesbury Av., Cambridge Circus, W.C.2. Phone: Temple Bar 4875 (2 lines). [3963]
LOUD Speaker Repairs, British, American, etc.; any make transformer coils rewound; alterations.— **Sinclair Speakers**, Alma Grove, Copenhagen St., N.1. [4030]

NATIONAL RADIO and TELEVISION SERVICE Co., Leading Service Engineers and Car Radio Experts, 155-157, Great Portland St., W.1. Phone: Langham 3477. [3911]
GUARANTEED Repairs. — Any transformers, choke, motor, armature, converter, dynamo, etc.; keenest prices, immediate quotation; prompt, dependable service.—See below.

L.T.P. (LONDON TRANSFORMER PRODUCTS, Ltd.), Willesden, N.W.10. Willesden 6486 (3 lines). [3470]
POULTNEY and **PURVIS**, British and American Service, trade or private; "W.W." sets a speciality; free collection, estimates.—147, Pitsanger Lane, Ealing, W.5. Perivale 3765. [4147]
MAINS Transformer Service.—Repairs, rewinds, or constructions to specification of any type; competitive prices and prompt service.—**Sturdy Electric Co.**, Dip-ton, Newcastle-on-Tyne. [0516]

F. E. GODFREY, A.M.I.R.E., qualified to build, repair and convert "Wireless World" sets, etc.; 25 years' experience; prompt service guaranteed.—30, Kemplay Rd., Hampstead. Hampstead 1104. [3509]
MIDLAND Service, repairs, all makes, including American, new chassis, amplifiers, constructional work, trade enquiries invited.—**Simmonds Bros.**, established 1922—38, Rabone Lane, Smethwick. (Smethwick 0751.) [4233]

ALL British or American Sets Repaired or Modernised by Qualified Engineers; satisfied customers throughout the world are your guarantee; send to-day for free estimate; free collection 10 miles radius of London.—**Scott-Sessions and Co.**, Exchange Works, Dukes Avenue, Muswell Hill, London, N.10. Phone: Tudor 4101. [0552]
REPAIRS to Moving Coil Speakers a Speciality; cones and coils fitted, fields altered; prices, including eliminators, quoted, loud speakers, 4/-; L.F. and output transformers, 4/-, post free; guaranteed satisfaction; trade invited; estimates free; prompt service.—**Loud-Speaker Repair Works**, 5, Balham Grove, London. Battersea 1321. [0394]

TRANSMITTING APPARATUS

G5N1.—The recognised distributors for amateur equipment, National, R.M.E., Thordarson, Hammarlund, McMurdie, Mallicratters, etc.; send 1/4d. stamp for catalogue.—**Radiomart**, 44, Holloway Head, Birmingham. [0531]

MISCELLANEOUS

CHEAP Printing.—1,000 billheads, 3/6; sample free.—**Creteaway Press**, 18, Buxted, Sussex. [4113]
WHEATSTONE Bridge, fitted 17 plugs, second-hand, by high class maker, 8/-; postage, 1/-; Ampmeter, Hot Wire. 7/6, postage 3d.—**Beaton's Stores**, 63, Chalk Farm Rd., N.W.1. [4241]
G.P.O. Engineering Dept. (no experience required); commencing £3/13 per week; age 18-23; excellent prospects.—Free details on Entrance Exam. from B.I.E.T. (Dept. 574), 17-19, Stratford Place, London, W.1. [4160]

EXTENDED PAYMENTS

LONDON RADIO SUPPLY Co. (Established 1925) supply on convenient terms, components, accessories and sets, any make, 10% down, balance over 12 months; send for list of requirements.—11, Oat Lane, London, E.C.2. [0337]
HIRE-PURCHASE—Prompt delivery of any radio apparatus on convenient terms.
WARD, 46, Farringdon St., London, E.C.4. Tel: Holborn 9705. [0539]
ELECTRIC CLOCKS
SMITHS and **Ferranti** Electric Clocks, Waltham and Russell watches and clocks; traders' enquiries invited.—**Leonard Hayes**, 36, Henry St., Blackpool. [0526]

RADIOMART SHORTWAVE SPECIALISTS

MICROVARIABLES.—All brass construction, latest ceramic insulation. The finest condensers made: 15 mmfd., 1/4; 40 mmfd., 1/7; 100 mmfd., 1/10; Transmuting Type.—070in. spacing, 15 mmfd. (neutralising), 2/9. 40 mmfd. Tuning, 3/6. These are quality.

SHORTWAVE COILS.—(RD4), CA 11-25, CB 20-45 metres, 2/6. CC 44-100 metres, 2/9. Standard 6-pin types, CA8, CB6, 2/9 each; CC6, 3/-; same range as 4-pin. **COILFORMS.**—Moulded in RD4 natural lobliss material, hollow resilient pins, 1 1/2in. diameter, ribbed; identification disc in top. Four types, 4-pin, 1/6; 6-pin (standard or to fit 7-pin valveholders), 1/9; 7-pin (for bandspread tap), 1/10; Machine threading, 2d. extra.

AMERICAN Mains Transformers, 230 v. primary, fully shrouded, 350-0-350, 6.3 v., 5 v., 6/11; Ditto, heavy duty up to 10 valves 150 m.a., weight 8 lbs., 12/6; Majestic, 250-250 2.5 v., 5 v., 4/11; Pilot 260-260, 2.5 v. C.T., 5 v. C.T., 5/11. Ceramic American Valveholders 1/- each.

HEAVY DUTY Mains Transformer, worth 35/-, 350-350, 150 m.a., 4 v., 2.5 A., CT, 4 v., 6 A CT, 12/6; Philips 270-270, 120 m.a., same LT's, 6/6; Ditto, 300-300, 60 m.a., 4 v., 2 A., 4 v., 4 A., 4/11; Speaker Transformers, 2/6. **UTILITY** 8/6, Microdisc Dials, 3/11; Radiophone, 0.00016 Shortwave Condensers, 3/6; Series gap twin, 3/9. Shortwave HF Chokes 5-100 metres, 9d.

465 **KG Litz** Wound I.F.'s 3/11; 2) Speed slow motion knobs 1/-; Telsen Ace Transformers 1/11; Telsen Screened S.W. H.F.C. 1/-; Iron core H.F. chokes 1/-; Featherweight Headphones 2/6; Morse Practice Keys with buzzer and batteries 3/6.

ELECTROLYTICS. Huge purchase 500 v. Aluminium Can, 4 mf., 1/6; 8 mf., 1/11; 16 mf., 2/6; 8+8 mf., 2/6; 8+8 mf. 450 v. + 8 mf. 250 v., 2/9; Block type, 500 v. peak, 4+4 mf., 1/6; 8+8+4 mf., 3/-; 50 mf. 50 v., 1/3; 25 mf. 25 v., 1/-; 2 mf. 300 v., 9d.; 40+24 mf. 200 v., 1/6.

FAMOUS CONTINENTAL A.C. Valves, 4/6; Battery types from 2/3; American Duotron, etc., all types, 3/6; All types of RCA Licensed first grade tubes, metal and glass, in stock from 5/6.

BRITISH RADIOPHONE .0005 straight or superhet 3-gang fully screened condensers with trimmers 4/11; Utility Midget 2-gang ditto 3/11; S.L. Dial to suit above 2/11.

SMOOTHING CHOKES, 20 hy., 120 m.a., 3/11; 40 m.a., 1/11; Centralab Pots, all sizes, 1/6; switched, 2/-; 20,000 ohm Pots, 1/-; Tubular glass fuses, 2d.

SPECIAL OFFERS. Class B Kit, worth 30/-, comprising Driver Transformer, Valve and Holder, 5/-; Dozen wire ended assorted resistors, 1/6. Preset Condensers, 9d. TELSEN switched Dual range coils (W216), 2/11.

TRADERS: Monster Bargain Parcels value £4/10/0, for 10/-; also 5/- parcels. State Battery or mains. Millammeters 25 m.a. upwards, 5/9; super, 6/9.

PUSHBACK Wire, 6 yds., 6d.; heavy, 9d.; Resin cored Solder, 6ft., 6d.; Screened Flex, single, 6d. yd.; twin, 9d. yd. Assorted Solder Tags, 6d. packet.

CONDENSERS, 4 mf. 700 v. T., 2/6; 2 mf., 1/6; T.C.C., 1 mf., 6d.; Dabiller, 0.1 mf., 3d.; Tubular Condensers, 1,500 v. T., all sizes to 0.1 mf., 6d.; 0.2 to 0.5 mf., 8d.

UTILITY 2-gang Uniknob .0005 with Dial, 3/11; EDC Converters, new, 12 volt to 240 v. 40 m.a., 25/-; BTH ditto, 6 v. input to 180 v. output smoothed, 35/-.

K.B. 7" M.C. Speakers 1,500 ohms 4/6; Philips Speaker Transformers to suit 2/6. Rola F720 P.M.-Universal Transformer, 19/9.

PHILIPS Screened Ceramic and Brass All-wave .0003 Micro-Variables. Ideal experimenters, 10d. Visual Tuning Meters, 2/- Crypto 1 kW. DC to AC Converter, 230 v., £7/10/-.

Order 5/- post free. Get our Bargain Catalogue, 1 1/2d. post free. All enquiries and requests for Catalogue must send 1/4d. stamp.

RAYMART 1936-7 EDITION

RAYMART SHORTWAVE MANUAL

48 Pages of practical circuits and data on Shortwave Receivers, transmitters, modulators, transceivers, etc., including information on transmitting licences, "class B" modulation, aeriels, etc. Price with Catalogue 6d., or 7 1/2d. post free. Catalogue only, 1 1/2d. post free.

BIRMINGHAM RADIOMART (G5N1)
 19, John Bright Street and Dale End
 MAIL ORDER DEPT. "W"

44 HOLLOWAY HEAD,
 BIRMINGHAM. TELE.: MID. 3254

EXCHANGE

I BUY, sell, exchange good quality receivers, accessories, components; H.P. facilities; promptness, efficiency.—**Bostock**, 1, Westbourne Terrace, S.E.23. Forest Hill 2236. [0529]

PATENT AND TRADE MARK AGENTS

GEE and Co. (H. T. P. Gee, Mem. R.S.G.B., A.M.I.R.E., Estab 1905), 51-52, Chancery Lane, London, W.C.2 (2 doors from Government Patent Office). Holborn 4547 (2 lines). Handbook free. [0001]

TUITION

RADIO Training.—Marine, aircraft, broadcast; prospectus free.—**Hull Municipal Technical College**. [0523]
PRACTICAL Radio and Television, private or postal training; particulars free.—**R.T.I.**, 39-47, Earl's Court Rd., W.8. Western 6917. [3758]

WANTED

WANTED, Rotary Converter, 230 direct to 230 alternating.—**Laws**, Market St., Birkenhead. [4251]

WANTED, all types modern radios, chassis and apparatus.—Write **H. R. Radio**, 41, Hecley Rd., London, W.12. [4248]

ROTARY Transformer Wanted, 6 or 12 volts input, 400 volts out.—**Straw (Radio)**, Ltd., St. John's St., Colchester. [4212]

WE Buy for Cash All Types of Modern Second-hand Radio Sets and Accessories, test meters, parts, etc.; we pay more than any other dealer; part exchanges; bring, send, or will call.—**University Radio, Ltd.**, 82, Hampstead Rd., London, N.W.1. Phone: Euston 3810. [4193]

SITUATIONS VACANT

AIR Ministry.
DIRECTORATE OF TECHNICAL DEVELOPMENT.

VACANCIES for Draughtsmen (Grade II) at the Royal Aircraft Establishment, South Farnborough, Hants, for detail work in connection with the design of wireless apparatus. Candidates should have had training in electrical engineering and drawing office experience of radio or light electrical instrument work.

SALARY up to 82/- a week, depending on experience.

THE Appointments will be Non-pensionable, but entrants will be eligible for promotion to draughtsmen, Grade I (salary £220 a year, rising to £330 a year) as vacancies arise. Grade I draughtsmen are considered for appointment to pensionable posts as vacancies arise on the permanent establishment.

APPLY, quoting reference 268 I, and stating age, qualifications and experience, to the Chief Superintendent, Royal Aircraft Establishment, South Farnborough, Hants.

CLOSING Date for the receipt of applications is May 1st, 1937. [4216]

AIR Ministry.
WIRELESS or Electrical Instrument Makers or Fitters Required at **Bawdsey Research Station**, **Bawdsey Manor**, **Woodbridge**, **Suffolk**. Candidates able to do own machine work preferred.

RATE of Pay, 70/-/73/6 for a week of 47 hours.

APPLY by Letter, stating age and experience, to the Superintendent, **Bawdsey Research Station** (Dept. W.W.), **Bawdsey Manor**, **Woodbridge**, **Suffolk**. Closing date for receipt of applications is **April 23rd, 1937**. [4222]

CROWN Agents for the Colonies.
COLONIAL Government Appointments.

APPLICATIONS from Qualified Candidates are Invited for the Following Posts:—

EUROPEAN Wireless Officers Required by the Governments of Kenya, Uganda and Tanganyika for the Joint Postal Service for one year in the first instance, with possibility of permanent appointment to the Local Civil Service; salary £360-£420-£540 a year; free passages, with liberal leave on full salary. Candidates, aged 25-38, should hold the first class certificate of the Postmaster-General as Wireless Telegraphists, or the equivalent certificate of the Air Ministry, and must have had experience in the operation and maintenance of long, medium and short wave radio stations, including direction finding service with ships and aircraft.

APPLY at once by letter, stating age, whether married or single, and full particulars of qualifications and experience and mentioning this paper, to the Crown Agents for the Colonies, 4, Millbank, London, S.W.1. quoting M/5150. [4255]

APPRENTICE-ASSISTANT Required for Progressive Service Business.—**Twentieth Century**, **George St.**, **Sutton**. [4257]

THOROUGHLY Experienced Service Engineer Wanted, able to drive car.—**Straw (Radio)**, Ltd., **St. John's St.**, **Colchester**. [4220]

WIRELESS.—All students placed; Marconi approved school; G.P.O. licence; fees after training; boarders accepted.—**Dept. W/W.**, **Wireless School**, **21, Manor Gardens**, **Holloway, N.7**. [4085]

WIRELESS Operators and Engineers Urgently Required.—**Train** at Britain's leading colleges; fee after appointment; boarders; prospectus free.—**The Wireless College**, **Colwyn Bay**, or **The Wireless College**, **Calmore**, **Southampton**. [0541]

RADIO Engineer as Assistant for Laboratory Work Required by **Large Radio Receiver Manufacturers** in London. Practical experience in Modern Receiver and Test Apparatus design essential; good salary and prospects.—Write, giving full experience, to **Box 1494, c/o The Wireless World**. [4253]

RADIO Manager Required by **Large Works**, **A1 man** only, age 40-50, thoroughly experienced in engineering, manufacturing and market trends; give full particulars of experience, age, present salary and salary expected; enclose small unmounted photograph.—**Box 1373, c/o The Wireless World**. [4162]

SHAFTESBURY

offer
THE IDEAL MICROPHONE

for
**AMATEUR TRANSMITTERS
AND RECORDING**



In a test report of the Shaftesbury Velodyne "Supreme" Microphone "The Wireless World" (April 2, 1937) said:—
"Judging from the tests carried out, it can be said that the microphone is free from resonance and has an ostensibly flat characteristic up to at least 9,000 c/s, while even above this upper limit an appreciable output is evident."

As supplied to P.O. Research Laboratory, Dollis Hill, N.W. High fidelity performance: response within + or - 2 DB between 50 and 10,000 c.p.s. Output level -45 DB, saves one amplification stage. Finished in chromium plate, as illustrated. Specially shielded Transformer, 18". Floor stands available.

12

GNS. LIST.

Free technical data free on application to:—

SHAFTESBURY MICROPHONES

LTD.,

24, ALDERSGATE STREET, LONDON, E.C.1.

Telephone: NAT. 2521.

ALL WAVE CHASSIS

8-Valves, 4 Wave Bands

with B.V.A. valves, radio frequency stage, triode hexode frequency changer, 2 I.F. stages, double diode triode, and push-pull, ACO44 output, complete with escutcheon and short wave stations marked on scale. Price **£9**

Carriage and packing, 5/- extra.

Can be supplied on hire purchase if required. As the quantity of these chassis is limited, early application is requested to avoid disappointment. Send for further details of this chassis and suitable loudspeakers, gramophone motors, etc. to:

CHAS. F. WARD, 45, Farringdon Street, London, E.C.4

Tel: HOL. 9703.

ENGINEERS! ARE YOU EARNING LESS THAN £10 PER WEEK?

If so, you cannot afford to carry on without reading our 208-page Handbook. The book explains clearly and definitely many ways of carving out a successful career. Among other things, it explains the Services of our unique Appointments Department; outlines Home-Study Courses in all branches of Civil, Mechanical, Electrical, Motor, Aero, Wireless, "Talkie," Engineering, Building, Govt. Employment, etc., and gives details of B.Sc., A.M.I.C.E., A.M.I.E.E., A.M.I.Mech.E., A.M.I.A.E., A.M.I.W.T., A.M.L.R.E., G.P.O., MATRIC, and all Exams. We Guarantee—"NO PASS—NO FEE." Whether you be an old hand or a budding apprentice, get this book to-day—FREE and POST FREE.



BRITISH INSTITUTE OF ENGINEERING TECHNOLOGY
387, Shakespeare House, 17/19, Stratford Place, London, W.1.

SITUATIONS VACANT

TECHNICAL Assistant Required for Calibration and Development Work on Electrical Measuring Equipment.—State age, experience, and salary required to Pye Radio, Ltd., Dept. 44/WW/TA, Cambridge. [4211]

TELEVISION Laboratories in London Require Technical Assistant; applicants must have specialised in practical ultra short wave radio and amplifier design for television, and should be of intermediate or B.Sc. standard.—Write, stating experience and salary required, to Box 1497, c/o The Wireless World. [4239]

RESEARCH and Development Engineer Wanted to Assist in Design of Interference Suppressors, aerial systems, fuses and radio components, laboratory experience and sound knowledge of mathematics and physics essential. B.Sc. degree or equivalent an advantage; apply by letter only, stating age, experience and salary required, to Belling and Lee, Ltd., Cambridge Arterial Rd., Enfield, Middlesex. [4215]

SITUATION WANTED

YOUNG Man Requires Position, first class P.M.G. experience in fault tracing and servicing and receiver design, also knowledge of television.—Box 1496, c/o The Wireless World. [4238]

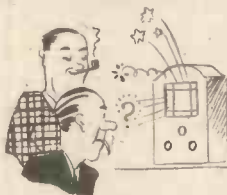

Cried Smithson, "What's this that I've got, Is it Mars or Australia, or what? But his pal merely said, You've got crackle, instead Of the Fluxite your wiring did not!"

See that **FLUXITE** is always by you—in the house—garage—workshop—wherever speedy soldering is needed. Used for 30 years in Government works and by leading engineers and manufacturers. Of Ironmongers—in tins, 4d., 8d., 1/4 and 2/8.

Ask to see the **FLUXITE SMALL-SPACE SOLDERING SET**—compact but substantial—Complete with full instructions, 7/6.

Write for Free Book on the art of "SOFT" SOLDERING—and ask for leaflet on CASE-HARDENING STEEL and TEMPERING TOOLS with FLUXITE.

TO CYCLISTS! Your wheels will NOT keep round and true unless the spokes are tied with fine wire at the crossings AND SOLDERED. This makes a much stronger wheel. It's simple—with FLUXITE—but IMPORTANT

THE FLUXITE GUN

is always ready to put Fluxite on the soldering job instantly. A little pressure places the right quantity on the right spot and one charging lasts for ages. Price: 1/6.



ALL MECHANICS WILL HAVE

FLUXITE

IT SIMPLIFIES ALL SOLDERING

FLUXITE LTD., Dept. W.W., DRAGON WORKS, BERMONDSEY ST., S.E.1

★ PRAISE FROM THE PRESS CLUB for Savage Sound.....

Dear Sir,

I am desired by my committee to tender you sincere thanks for the splendid installation of public address equipment recently installed in our dining room by you, not only for the very workmanlike manner in which your engineers carried out the work, but also the very helpful guidance given by your representative which has resulted in perfect reproduction.

My committee and members are full of praise for the amazing improvement this has made at our house dinners.

Yours faithfully,
A. LAZENBY,
Manager-Secretary

W. BRYAN SAVAGE LTD.



WESTMORELAND ROAD, LONDON, N.W.9
PHONE: COLINDALE 7131 (3 LINES)

BTH SOUND AMPLIFYING EQUIPMENT

THE FINEST TONAL QUALITY IN THE WORLD

BTH Equipment is used for the largest and most comprehensive Sound Amplifying Systems in this country.

BTH RUGBY
THE BRITISH THOMSON-HOUSTON COMPANY LIMITED, RUGBY, ENGLAND
A2319N

The Autocar

The Leading Motoring Paper
EVERY FRIDAY 4d. W.W 16

INDEX TO ADVERTISEMENTS

	PAGE		PAGE
All-lower Transformers, Ltd.		Institute of Wireless Technology	
Belling-Lec. Ltd.	3	McCarthy Radio, Ltd.	Edit. 383
Birmingham Radiomart G5N1	7	Midwest Radio, Ltd.	Inside Front Cover
British Institute of Engineering Technology	8	M.P.R. Electrical Co.	
British Insulated Cables, Ltd.		M.R. Supplies	4
British Rola Co., Ltd.		Parmeko, Ltd.	1
British Sound Recording	Edit. 387	Peto-Scott, Ltd.	4
British Thomson-Houston Co., Ltd.	8	Player's Cigarettes	Inside Front Cover
Bulgin A. S. & Co., Ltd.	1	Postlethwaite Bros.	4
Colvern, Ltd.	Front Cover	Premier Supply Stores	5
Cosser, A. C., Ltd.		Savage, W. Bryan	8
"Drydex"		Scott Sessions, Ltd.	
Electrad: Radios	6	Shaftesbury Microphones	8
Exide, Ltd.		Sonnad Sales, Ltd.	6
Fluxite	8	Stern, S.	
Forbat, Eugene J.	8	Tannoy Products	5
Gardners Radio, Ltd.	4	Telegraph Condenser Co.	Front Cover, Edit. 385
Hartley Turner Radio, Ltd.	2	Universal Radio Distributors, Ltd.	1
Haynes Radio	Front Cover	Ward, C. F.	8
Henley's W.T. Cable & Wireless Works	1	Wright & Weaire, Ltd.	5

FOUNDATIONS of WIRELESS

*A Book of
First Principles
for the
Wireless
Enthusiast*

PRICE 4/6 NET
By Post 4/11

Issued in conjunction with
"THE WIRELESS WORLD"
and published by the Proprietors—

By A. L. M. SOWERBY, M.Sc.
An Elementary Text Book on Wireless Receivers

"Foundations of Wireless," based on a series of articles which appeared in "The Wireless World," covers the whole field of wireless from the simplest electrical phenomena to the construction of a modern set, and all the vital points in receiver-design are treated in full detail. Chapters are devoted to direct and alternating currents; typical circuits; the properties of inductance and capacity; the nature of high frequency currents; the tuned circuit; and amplification by the valve.

Eleven of the eighteen chapters of the book deal with the discussion of receivers in which the whole process of design is reviewed stage by stage to the finished article.

Special attention is paid to the important subject of tuned circuits and band-pass filters, on the correct design of which the performance of every type of set ultimately depends. Moreover the process of detection, so often imperfectly understood, is clearly explained.

ILIFFE & SONS LTD., DORSET HOUSE, STAMFORD STREET, LONDON, S.E.1

RADIO RECEIVER MEASUREMENTS

By Roy M. Barnard, B.Sc., A.M.I.R.E.
(1934)

Although primarily designed for the benefit of the radio service engineer, this concise handbook is also of practical value to the amateur experimenter.

It describes the methods of measuring receiver performance and provides provisional standards as a basis for judging performance. Measurements of sensitivity, selectivity and fidelity are explained at length and the interpretation in estimating receiver performance is carefully set out.

Details are given of methods of receiver testing with full descriptions of commercial signal generators and their application to the adjustment of superheterodynes and "straight" receivers.

*Complete with fifty-three illustrations
and diagrams, summaries of method,
four appendices and a general index.*

PRICE 4/6 net By post 4/9

From all booksellers or direct from the Publishers

ILIFFE & SONS LTD., DORSET HOUSE, STAMFORD STREET, LONDON, S.E.1

W.W.19

Mention of "The Wireless World," when writing to advertisers, will ensure prompt attention.

Second Edition—

Completely Revised

RADIO DATA CHARTS**A SERIES OF ABACS***providing most of the essential Data required in Receiving Design*By **R. T. BEATTY, M.A., B.E., D.Sc.**

Published from the Offices of "THE WIRELESS WORLD"

RADIO DATA CHARTS provide designers of wireless apparatus with a ready, convenient means of solving all the more familiar problems connected with the design of modern radio apparatus without having recourse to complicated formulæ and mathematics.

In order to keep abreast of the great advances in wireless communications since the first edition of "Radio Data Charts" appeared, obsolete abacs have been omitted in this second edition and important fresh material added.

By the use of the present edition of "Radio Data Charts," such abstruse problems as the design of tuning coils are solved almost as easily as the simple application of Ohm's Law.

Price 4/6 net By post 4/10

(37 CHARTS and 46 Diagrams)

*From all leading booksellers or direct from the Offices of***"THE WIRELESS WORLD," Dorset House, Stamford Street, London, S.E.1**

W.W. 93

SECOND EDITION**—THOROUGHLY REVISED****WIRELESS SERVICING MANUAL**By **W. T. COCKING***(of "The Wireless World")*

The first complete book of reference of its kind. A reliable practical guide for amateur and professional.

The demand for this book was so great that the first edition was sold out in the short space of a very few months. A second edition containing additional material is now on sale. The "Wireless Servicing Manual" deals tully with Testing Apparatus and explains the methods of locating and curing faults in receiving equipment.

Ganging, Automatic Volume control, Instability, Distortion, Mains Hum, Whistles and Local Interference are all separately treated.

The new edition contains much additional information on short-wave receivers, and on methods of operating extension loud speakers, the reference material including base-connections for British, Continental and American Valves, and the various colour codes for components has been extended and brought up to date.

BOUND IN CLOTH BOARDS**SIZE 7½ ins. × 5 ins.****231 PAGES**

PRICE 5/- net. By post 5/4

Issued in conjunction with "THE WIRELESS WORLD" and Published by the Proprietors:—
ILIFFE & SONS LTD., DORSET HOUSE, STAMFORD STREET, LONDON, S.E.1

W.W. 20



4^D

The Wireless World

THE PRACTICAL RADIO & TELEVISION JOURNAL

Friday, April 23rd, 1937.

IN AN AGE OF SPEED
(with a good excuse)

"ONE RUNS HOME TO ONE'S SOUND SALES RADIO"

(Extract from a recent testimonial, original can be seen at our office with pleasure.)

May We Send You Further Particulars?



MARLBOROUGH ROAD,
UPPER HOLLOWAY,
LONDON, N.19.



(Contractors to the G.P.O., etc.)
Tel.: Archway 1661/2/3.

EVERY Radio TEST with ONE Meter

For servicing and laboratory work an accurate multi-range meter is essential. The Model 7 Avometer provides unique facilities for all radio tests. It is an A.C./D.C. meter, having 46 ranges. Measures A.C. and D.C. amperes and volts, also resistance, capacity audio-frequency power, and decibels. No external shunts or series resistances. Extremely low current consumption ensures great accuracy. Meter protected against damage through overload by an automatic cut-out. Conforms to B.S. 1st grade requirements.



BRITISH MADE
16 Gns.

Resistance Range Extension Unit (measurements down to 1/100th ohm) ... 10/- extra.
The 36-range Universal Avometer, 13 Gns.
22-range D.O. Avometer, 9 Gns.
Carrying Case, 8/-
Deferred Terms if desired.

★Write for descriptive pamphlet.
THE AUTOMATIC COIL WINDER & ELECTRICAL EQUIPMENT CO. LTD., Winder House, Douglas Street, London, S.W.1. Phone: V10. 3404/7

The 46-RANGE UNIVERSAL AVOMETER 7
Regd. Trade Mark

HAYNES QUALITY RECEIVERS

Demonstration night—every Friday,
7.30—9.30 p.m.

Originators of the Quality Receiver.



Have you the Haynes Quality Booklet?
1936-37 Edition.

QUEENSWAY, ENFIELD, MIDDLESEX.
Enfield 2726

Central London area Agent, London Radio Supply Company, 11, Oat Lane, E.C.4.
Hire purchase arranged.

CAV DRY BATTERIES



60 VOLTS 3'9
99 VOLTS 6'3
108 VOLTS 6'9
120 VOLTS 7'6

The Finest British Battery of Standard Capacity

C. A. VANDERVELL LTD. WELL ST., BIRMINGHAM



When east meets west — at Mica

Many years spent in combing the world for the finest materials serve us well in manufacturing our Mica condensers. But we do not base our claim for superiority on materials alone. Our care and attention in their manufacture, and their acknowledged superior electro-technical design, have all helped to give them a world-wide reputation for reliability.

As an individual advantage, we might mention that they are moulded in a high insulation bakelite by a process ensuring perfect sealing and protection. Dubilier Mica Condensers have low power factor, small size, small weight and are obtainable in a wide variety of types—some of which are arranged for colour coding.

**DUBILIER
CONDENSERS**

DUBILIER CONDENSER CO. (1925) LTD., DUCON WORKS, VICTORIA ROAD, NORTH ACTON, LONDON, W.3



C. R. Casson 124

Mention of "The Wireless World," when writing to advertisers, will ensure prompt attention.

The Wireless World

THE
PRACTICAL RADIO
JOURNAL
27th Year of Publication

No. 921.

FRIDAY, APRIL 23RD, 1937.

VOL. XL. No. 17.

Proprietors: ILIFFE & SONS LTD.

Editor:
HUGH S. POCOCK.

Editorial,
Advertising and Publishing Offices:
DORSET HOUSE, STAMFORD STREET,
LONDON, S.E.1.

Telephone: Waterloo 3333 (50 lines).
Telegrams: "Ethaworld, Sedist, London."

COVENTRY: Hertford Street.
Telegrams: "Autocar, Coventry." Telephone: 5210 Coventry.

BIRMINGHAM:
Guildhall Buildings, Navigation Street, 2.
Telegrams: "Autopress, Birmingham." Telephone: 2971 Midland (4 lines).

MANCHESTER: 260, Deansgate, 3.
Telegrams: "Iliffe, Manchester." Telephone: Blackfriars 4412 (4 lines).

GLASGOW: 26B, Renfield Street, C.2.
Telegrams: "Iliffe, Glasgow." Telephone: Central 4857.

PUBLISHED WEEKLY. ENTERED AS SECOND
CLASS MATTER AT NEW YORK, N.Y.

Subscription Rates:
Home, £1 rs. 8d.; Canada, £1 rs. 8d.; other
countries, £1 3s. 10d. per annum.

*As many of the circuits and apparatus described in these
pages are covered by patents, readers are advised, before
making use of them, to satisfy themselves that they would
not be infringing patents.*

CONTENTS

	Page
Editorial Comment	389
Ultra - Short - Wave Quality Re- ceiver	390
Sunspots and the Short - Wave Listener	394
Current Topics	397
Television Interference Test Set ..	398
Murphy A36 Receiver Reviewed ..	400
Broadcast Brevities	403
Listeners' Guide for the Week ..	404
About Push-Push	406
Random Radiations	408
Distant Reception Notes	409
New Apparatus Reviewed	410
Letters to the Editor	411
Recent Inventions	412

EDITORIAL COMMENT

Electrical Interference *Disappointing Delay*

IT is a matter of considerable disappointment to learn that the Postmaster-General holds out no hope that the Bill to give effect to the Recommendations of the Committee on Electrical Interference can be introduced during the present session of Parliament. Every additional delay which occurs aggravates the situation, because the distribution of domestic and other electrical plant which interferes with broadcast reception is going on at a tremendous rate.

Some of the larger electrical firms are, we are glad to know, taking some steps, in anticipation of legal control, to make the apparatus which they market interference-free on a voluntary basis. It seems unfair, however, that these conscientious firms should be put to an additional manufacturing cost, however small, whilst other firms competing with them are content to sit back and do nothing until legislation compels them to act.

We have also to take into account the position with regard to electrical equipment imported from abroad which, in the absence of controlling regulations, may be the cause of a large amount of the electrical disturbances irritating the listener.

Now that we are aware that legislation, although delayed, is as good as certain to go through, we feel it is time that the purchaser of apparatus, whether for domestic or other uses, should satisfy himself that the equipment is interference-free. If he does not do so, he will no doubt find, in a matter of some months' time, that he has to make arrangements to fit suppressing devices to the apparatus at his own cost, and when once apparatus has been installed it becomes a more costly matter to suppress the interference than if the manufacturer

does it at the time of supplying. The purchaser would probably find that even though some additional charge was made when the apparatus was installed, it would prove worth while to have it done then rather than later on.

Once the apparatus has been sold, it is the user who will become liable, so that we feel the time has certainly arrived when every purchaser of electrical equipment should be made conscious of this obligation which will soon devolve upon him.

The Co-Axial Cable *Importance to Television*

LAST week Colonel Angwin, Deputy Engineer-in-Chief of the Post Office, gave a technical description of the much-discussed new co-axial cable, the most spectacular telephone development of recent years, at a meeting of the Institution of Electrical Engineers.

This cable has been designed primarily for telephone requirements of the Post Office by Standard Telephones & Cables, Ltd., but it is in its application to television that it interests our readers. The cable is already laid between London and Birmingham, extending from thence to Manchester and on to Newcastle. Additional routes are being arranged.

The cable provides at present the only alternative to short-wave wireless links for carrying television. It should now be possible to erect television transmitters at Birmingham and elsewhere and feed the transmitters from London studios.

The cost to the B.B.C. of the use of the cable has not yet been disclosed, but it seems certain that it will not be more than the expenditure involved if the B.B.C. had to establish local studios and programmes for each television transmitter erected.

Ultra-Short-Wave Quality

A STRAIGHT SET FOR THE PUSH-PULL QUALITY AMPLIFIER

IT is possible to obtain a much higher standard of quality of reproduction on the ultra-short waveband than on the ordinary broadcast band because the higher musical frequencies can be transmitted without causing interference with neighbouring stations. Frequencies well above 15,000 c/s are transmitted by stations such as the Alexandra Palace sound transmitter, and a considerable improvement in the reproduction is noticeable, especially in the case of transient sounds.

At the time of writing there is a project for the programme of one of the London stations to be relayed on the ultra-short waveband, and when this takes place London listeners will have an opportunity of obtaining extraordinarily good quality.

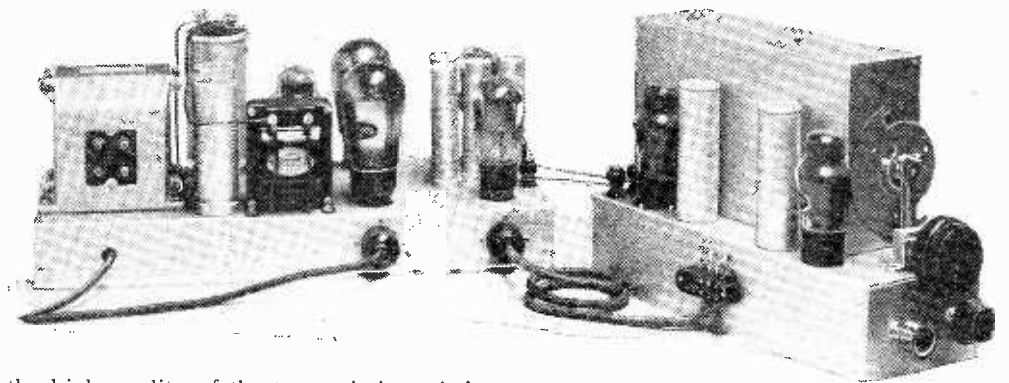

the high quality of the transmissions, it is obvious that the receiver itself must be suitable. It is, of course, quite possible to receive such stations on an ordinary broadcast receiver with the addition of an ultra-short-wave converter. In few cases, however, will the quality then be an improvement over that obtained on the medium waveband, and it may be considerably poorer! Even the best broadcast receivers are likely to attenuate frequencies above 10,000 c/s considerably, and the majority start to cut-off at a much lower frequency. On this waveband there

vent howling, because any feed-back causes the oscillator frequency to vary. The ordinary broadcast set is much too selective to permit good reception to be obtained below 10 metres with a converter of simple type.

The wise course, therefore, is to build a special receiver, and the choice lies between superheterodyne and straight set. A superheterodyne is entirely satisfactory if designed especially for the job. It must not be too selective, and it should have a high intermediate frequency. Experience shows that a frequency of about 5.0 Mc/s is satisfactory. High sensitivity is readily obtained with such a receiver, but in general we do not need this, for in the reception of weak signals we shall find interference from car ignition systems. As we are out only for high-quality reproduction we shall do better to use a set of only moderate sensitivity, for it will be appreciably cheaper.

We thus come to the straight set, and experience shows that a single RF stage with a reacting detector will give a very

A side view of the receiver showing the detector and phase-reversing valves.

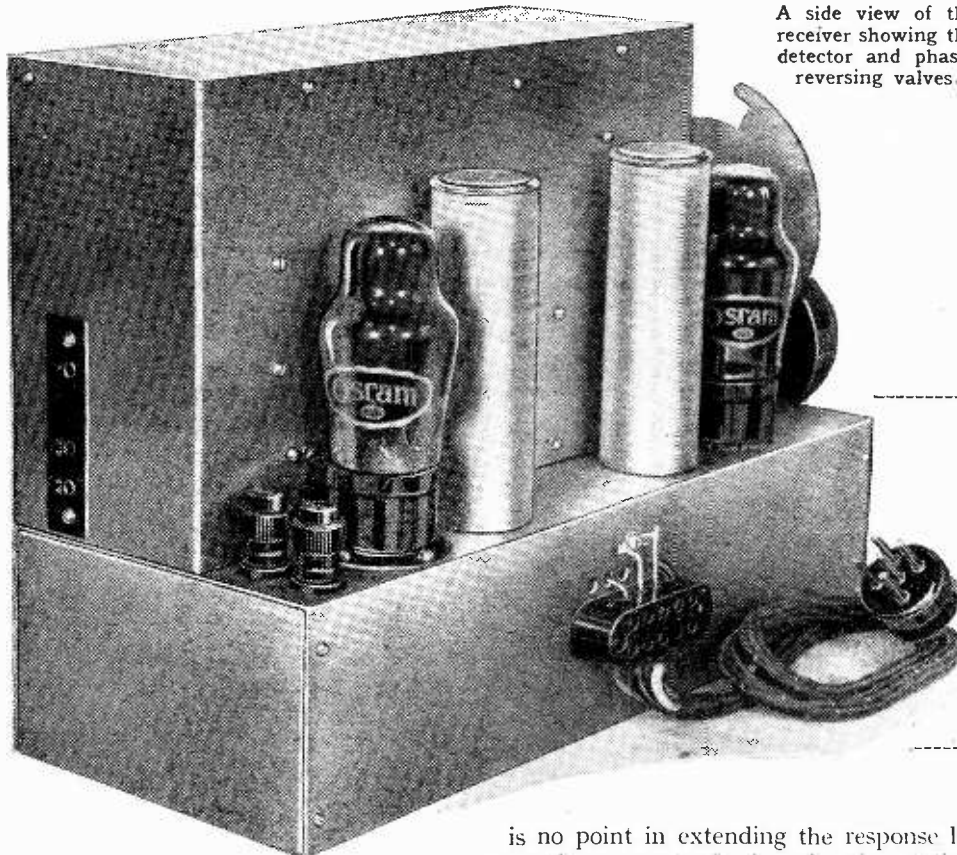

GOOD reception on wavelengths below 10 metres can be obtained with quite simple apparatus, and the receiver described in this article is designed primarily for use with the Push-Pull Quality Amplifier. An extremely high standard of reproduction is obtainable and the apparatus is easy to handle.

When such transmissions eventuate it seems probable that those who have the necessary receiving equipment will not willingly return to the medium-wave stations.

Now, if full advantage is to be taken of

is no point in extending the response beyond 10,000 c/s, for broadcasting stations themselves do not transmit frequencies much higher than this; moreover, it is only at short distances from a station that this degree of response can be tolerated on account of interference.

Furthermore, with an ultra-short-wave converter it is extremely difficult to pre-

satisfactory performance indeed. Such a receiver is easy to construct and handle, and is reliable in performance for it does not suffer from tuning drift.

The Ultra-Short-Wave Quality Receiver is designed for use with the Push-Pull Quality Amplifier,¹ the PA Amplifier,² or

¹ The Wireless World, May 11th and 18th, 1934. (A reprint is available at 7d. post free).

² The Wireless World, April 3rd and 10th, 1936.

Receiver

the amplifier of the Pre-tuned Quality Receiver,³ and its circuit diagram appears in Fig. 1. An RF pentode is used as the amplifier and a type having a high mutual conductance, no less than 6.0 mA/v, has been selected. Valves have a low input impedance at very high frequencies on account of the electron-transit time,⁴ and the grid is consequently tapped down the first tuned circuit, L2 C1.

The Tuning System

A tuned-anode coupling between the RF and detector valves is used, and the coil is centre-tapped for the HT connection, thus reducing the damping of the valves and enabling reaction to be obtained very simply. The reaction circuit is, in fact, analogous to that of a Hartley oscillator, and since it dispenses with a separate reaction coil it simplifies the coil construction.

The use of tapped coils in this way not only reduces the valve damping on the tuned circuits, but also reduces their minimum capacities and so allows a wide tuning range to be obtained with a small condenser. The tuning condensers C1 and C5 are of 40 μF . capacity only and yet a tuning range of over 7-12 metres is obtained. A trimmer C2 is fitted to the

³ *The Wireless World*, Sept. 25th and Oct. 2nd, 1936.

⁴ "Grid Loss at Ultra-High Frequencies," (Scroggie), *The Wireless World*, Oct. 23rd, 1936.

WARNING!

BEFORE using this receiver the centre-tap on the heater secondary of the mains transformer in the amplifier must be disconnected from the chassis.

In the Push-Pull Quality Amplifier, this is CT on the 4 volt 7.8 Amp. winding. In the PA Amplifier it is CT on the 4 volt 9 Amp. winding, and in the amplifier of the Pre-tuned Quality Receiver it is CT on the 4 volt 10 Amp. winding.

It is imperative that this alteration be made, for if it is not, there is a probability that the mains transformer will be burnt out.

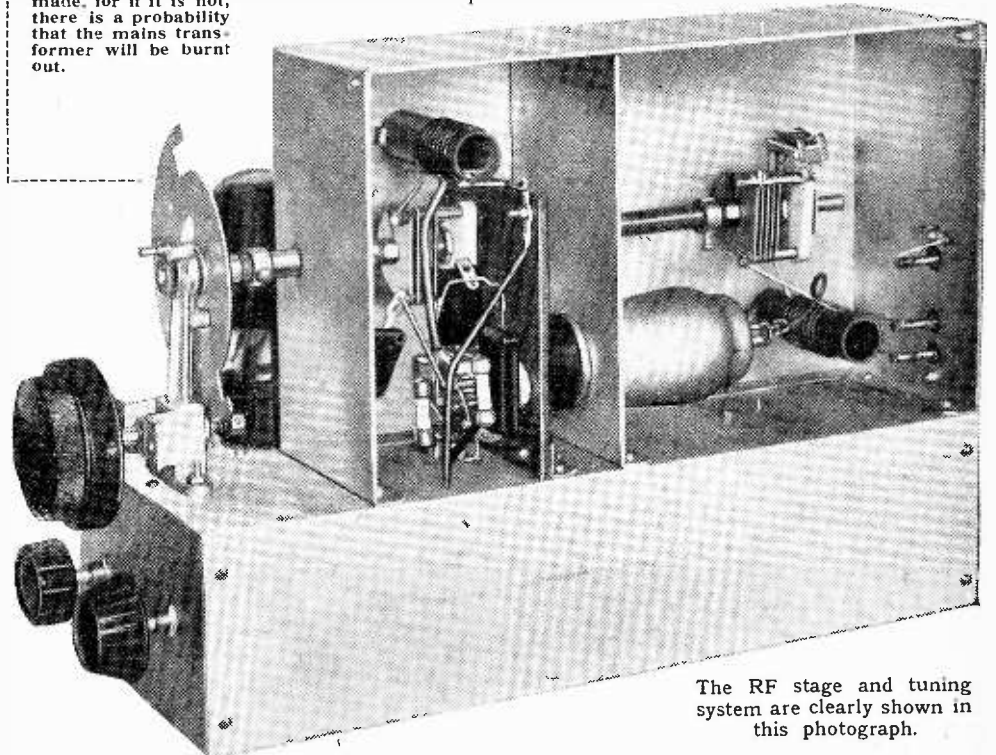

The RF stage and tuning system are clearly shown in this photograph.

aerial circuit to permit the circuits being reasonably well matched.

Since the RF valve requires the same voltage for the screen as for the anode, it becomes possible to use common de-

A triode detector is used, and the grid leak and condenser R5 and C7 have values which enable them to deal with high modulation frequencies. In the anode circuit, a resistance R6 of 10,000

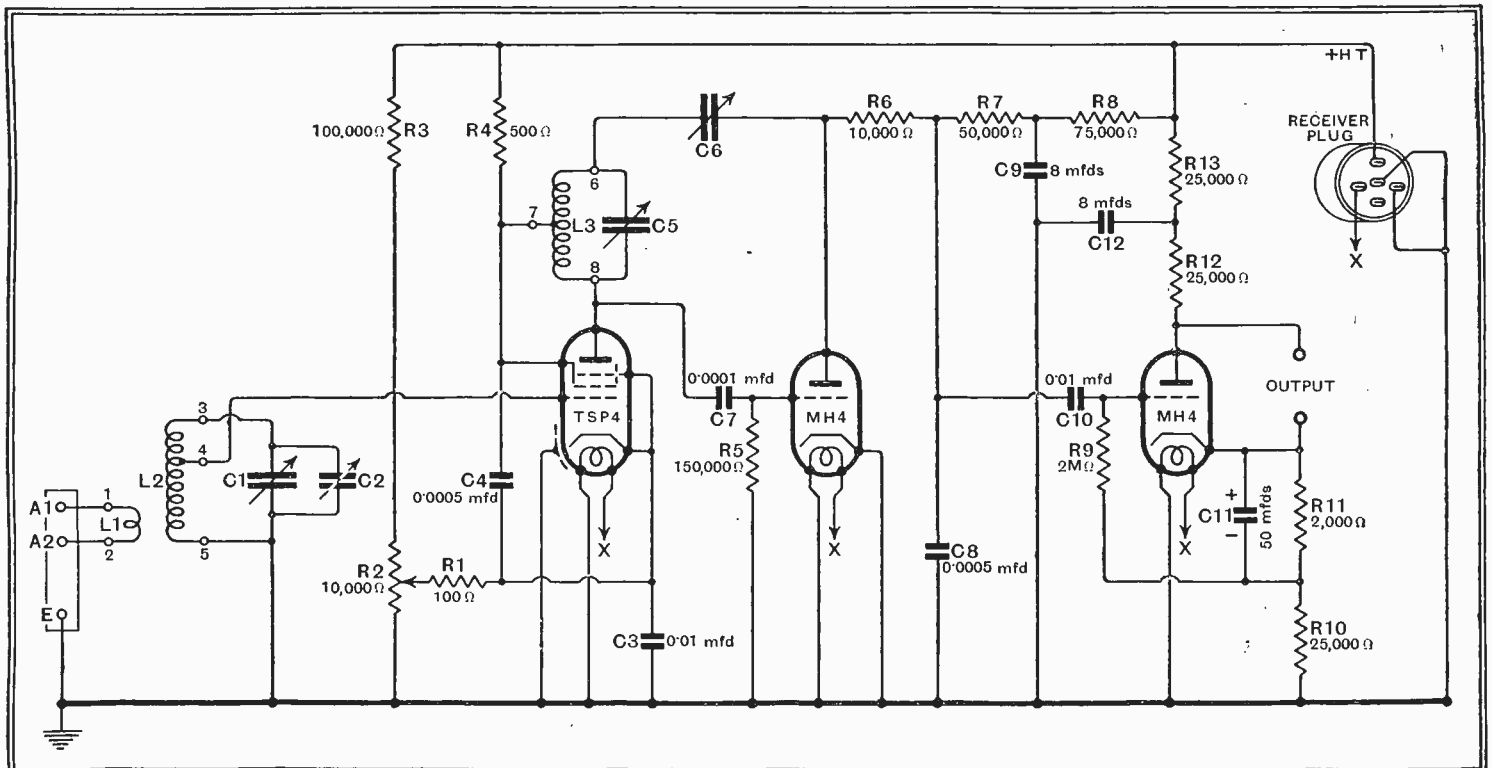

Fig. 1.—In this complete circuit it will be seen that an RF stage is used with a grid detector and that this combination is followed by a phase-splitting valve.

Ultra-short-wave Quality Receiver—
ohms is used instead of an RF choke, since it permits a more even response over a wide band, and reaction is controlled by the 15 $\mu\mu\text{F}$. condenser C6.

After this point, the circuit is conventional in that resistance coupling is used to the phase-splitting valve which operates with equal cathode and anode resistances R10 and R12.

One point in connection with the circuit will be noticed, and this is a departure from normal practice. One side of each valve heater is earthed directly instead of the centre-tap on the mains transformer. Past experience has shown that a large amount of interstage coupling occurs on heater wiring. The usual remedy is to connect condensers from heater to earth, but this is not only expensive but is only a partial cure. With the heaters earthed directly it has been found that feed-back in this circuit is almost completely eliminated; in fact, it has been found easy to stabilise high-gain amplifiers which proved

unhandleable with the normal connections.

Contrary to what one might expect, this direct earthing does not introduce mains hum. Because of this system of earthing, however, it is important to make sure that the mains transformer in the amplifier has the centre-tap of the appropriate secondary winding disconnected. If the centre-tap is not disconnected from the chassis, one-half of the winding will be short-circuited and the mains transformer will burn out unless the primary fuses blow and protect it.

Construction and Operation

The construction of the receiver is quite straightforward and calls for comment only in regard to one point. This is in connection with the couplings of the variable condensers and dial. The standard coupling units have a length of 4in., but the one used for coupling the two condensers must be cut to 2in. and the one

linking the dial to the first condenser to 1 $\frac{3}{4}$ in. After cutting, it is necessary to drill a fresh hole in the tube for the set-screw. A dipole aerial resonant to the station which is most frequently required is recommended, but very good results are obtainable with an ordinary outdoor aerial. The latter should be joined to A1 and A2 connected to earth.

The variable condensers should, of course, be linked so that they run in step and at a low wavelength, and C2 adjusted for maximum sensitivity while keeping the set just off the oscillation point by backing off reaction as the circuits come into tune. In most cases this adjustment is readily carried out even if no signal can be found, for there is usually sufficient background of ignition noise when the receiver is working all out.

Even with strong signals it will often be necessary to use some degree of reaction for the valve damping on the tuned circuits is heavy. In some cases, moreover, it will be found desirable to use re-

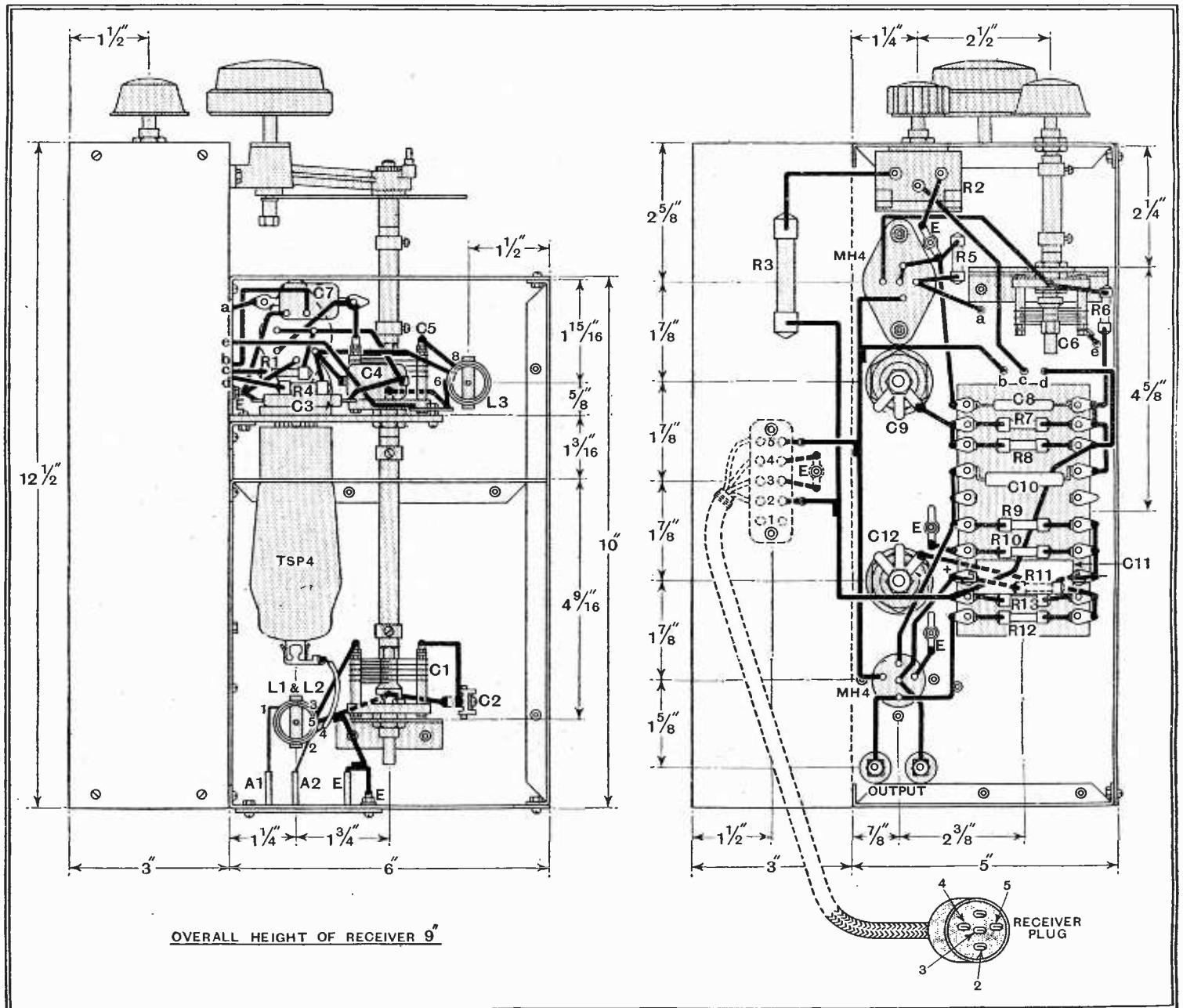

Fig. 2.—Complete constructional and wiring details are given in these drawings.

Ultra-Short-Wave Quality Receiver—

action to increase selectivity. When listening to the sound accompaniment to television, for instance, it is usually necessary to use reaction to sharpen the tuning in order to avoid interference from the vision signal. The sound may then be undesirably strong, and so it is reduced appropriately by the volume control.

Under normal conditions it is to be anticipated that good reception of the Alexandra Palace will be secured up to at least twenty-five miles when a dipole aerial is used. In many cases, of course, reception will be possible at greater distances,

1 Dial, dual ratio Eddystone 1070

Condensers:

- 2 0.01 mfd., mica, C3, C10 T.C.C. "M"
- 1 0.0001 mfd., mica, C7, T.C.C. "M"
- 2 0.0005 mfd., mica, C4, C8 T.C.C. "M"
- 1 50 mfd., 12 volts, electrolytic, C11 T.C.C. "FT"
- 2 8 mfd., 460 volts peak, electrolytic, C9, C12 T.C.C. 802

- 1 Socket strip Clix "C"
- 2 Terminals, ebonite shrouded, output +, - Belling-Lee "B"
- 1 Group board, 10-way Bulgin C32
- 1 Plug top valve connector Belling-Lee 1175
- 1 Connector, 5-way Bryce
- 1 Cable, 5-way, with twin 70/36 leads and 5-pin plug Goltone

Chassis:

- Miscellaneous:** Peto-Scott
- 2 Lengths Systoflex, 1 oz. No. 18 tinned copper wire, aluminium for brackets, etc. Screws: 48 6BA 1/4 in. R/hd.; 2 4BA 3/16 in. R/hd.; 2 6BA 1 in. R/hd., all with nuts and washers.

Valves:

- 1 TSP4, metallised Mullard
- 2 MH4, plain Osram

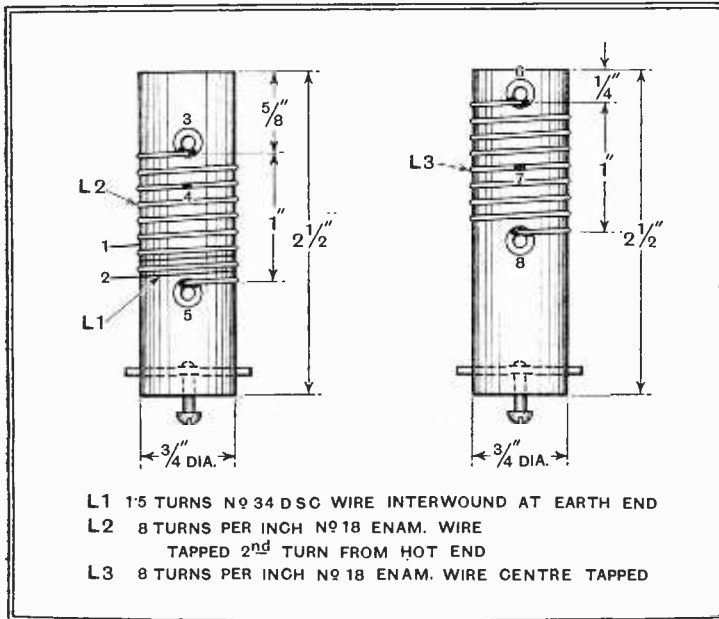

L1 15 TURNS NO 34 DSC WIRE INTERWOOUND AT EARTH END
 L2 8 TURNS PER INCH NO 18 ENAM. WIRE TAPPED 2ND TURN FROM HOT END
 L3 8 TURNS PER INCH NO 18 ENAM. WIRE CENTRE TAPPED

Fig. 3.—The construction of the coils is clearly shown in this illustration.

NEW BOOKS

Motoring Made Easy. Sixth edition, by R. F. Broad and the Technical staff of *The Autocar*. Pp. 133, with numerous illustrations. Published by Iliffe and Sons Ltd., Dorset House, Stamford Street, London, S.E.1. Price 2s. 6d.

THIS book, which is as invaluable to the experienced driver as it is indispensable to the novice, has been improved and amended where necessary. The chapter on "Law and the Motorist" has been brought completely up to date.

The International Mercantile Diary and Year-book, 1937. Published by Syren and Shipping, Ltd., 44-46, Leadenhall Street, London, E.C.3. Price (including quarterly copy of *The Merchant Shipper*) 10s. 6d.

THIS year-book, which is now in its 21st annual edition, contains everything which the exporter might wish to know about sending goods to any part of the world. Indexed under the various countries will be found details of Customs regulations, pack-

and this is undoubtedly the case with signals of longer wavelength.

On the 10-metre amateur band, for instance, American amateurs have been heard working telephony when conditions have been suitable. The receiver, however, is not really intended for such long-distance reception, for it is not selective enough for use in the amateur bands, and it requires some skill in tuning to get such signals.

For the purpose for which it has been designed, however, tests have shown it to be eminently satisfactory, and it forms an ideal sound receiver for television.

Resistances:

- 1 100 ohms, 1/2 watt, R1 Dubilier F 1/2
- 1 500 ohms, 1/2 watt, R4 Dubilier F 1/2
- 1 2,000 ohms, 1/2 watt, R11 Dubilier F 1/2
- 1 10,000 ohms, 1/2 watt, R6 Dubilier F 1/2
- 3 25,000 ohms, 1/2 watt, R10, R12, R13 Dubilier F 1/2
- 1 50,000 ohms, 1/2 watt, R7 Dubilier F 1/2
- 1 75,000 ohms, 1/2 watt, R8 Dubilier F 1/2
- 1 150,000 ohms, 1/2 watt, R5 Dubilier F 1/2
- 1 2 megohms, 1/2 watt, R9 Dubilier F 1/2
- 1 100,000 ohms, 2 watts, R3 Dubilier F2

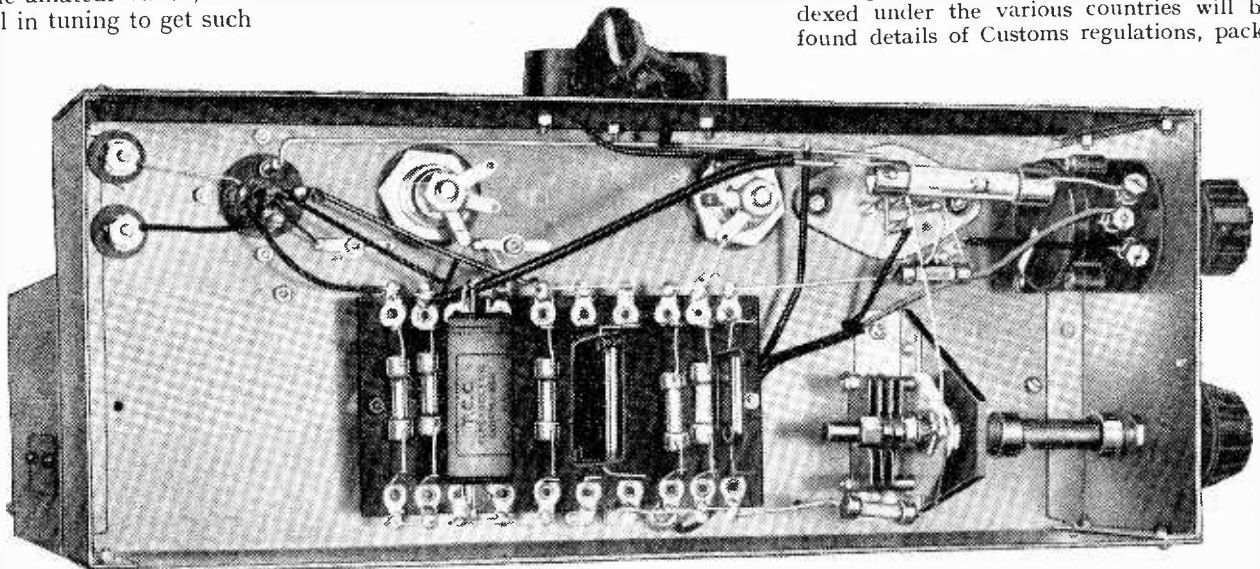

An underview of the receiver showing the wiring.

LIST OF PARTS.

Certain components of other makes but of similar characteristics may be used as alternatives to those given in the following list.

- 2 Variable condensers, 40 mmfds., C1, C5 "Apex Economy" Webb's Radio 14, Soho St., W.1.
- 1 Variable condenser, 15 mmfds., C6 "Apex Economy" Webb's Radio

- 1 Potentiometer, 10,000 ohms, wire-wound, R2 Haynes Radio
- 1 Trimmer, C2 Bulgin SW95
- 2 Coils (for constructional details see sketch)
- 3 Extension control outfits Eddystone 1008
- 1 Valve holder, 5-pin (without terminals) Clix Chassis Mounting Standard Type V1
- 1 Valve holder, 5-pin (without terminals) Clix Chassis Mounting SW Type V5
- 1 Valve holder, 7-pin (without terminals) Clix Chassis Mounting SW Type V5

ing and marking of goods, currency values and a host of similar information which varies so much in different parts of the world.

There are, in addition, forty pages of calendars, weights and measures and other useful formulæ, and also, of course, the diary portion which shows a week at an opening. The information in the year-book is brought up to date every quarter by *The Merchant Shipper*, which is posted free of charge to all subscribers.

Sunspots and

the

IN this article a non-technical description is given of the effect of solar activity on propagation of the short waves as revealed by sunspots. It is a matter of considerable importance to radio engineers since it influences the selection of radio frequencies for transmission to different parts of the world at various times of the day

THE approaching maximum sunspot period seems likely to be one of exceptional intensity, and the increasing solar activity is already having a marked effect on radio propagation phenomena, particularly in regard to the frequencies above about 3 Mc/s. Solar activity moves in an eleven-year cycle, and the last maximum was reached in 1927-28, while a minimum period occurred during 1933, so that we will be due for another peak of activity in 1938-39, and, as we are now in a far better position than we were in 1928 to take full cognisance of the effects produced upon short-wave propagation, some interesting

A recent photograph of the sun taken at the Greenwich Observatory showing various groups of spots.

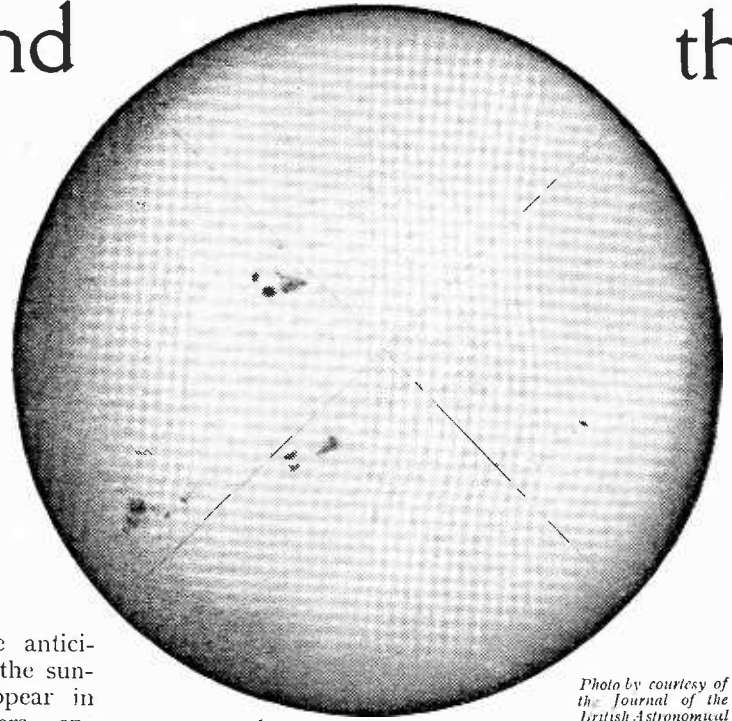

Photo by courtesy of the Journal of the British Astronomical Association and with the permission of the Royal Observatory, Greenwich.

developments may be anticipated. Already, as the sunspots continue to appear in ever-increasing numbers, engineers engaged in short-wave transmission are finding it necessary to make considerable modifications to the frequencies they employ to reach particular points on the earth's surface, and, when they have correctly interpreted the sunspot effect, some surprisingly good results have been obtained.

How Solar Radiation affects the Ionosphere

What then is the precise effect of solar activity on short-wave reception, and how is this effect brought about? It must be admitted, in reply to this question, that the work of correlating day-to-day short-wave reception conditions with sunspot activity is an exasperating business, and no exact accord between the two has in fact been achieved. Of course, the solar cycle does not take the form of a smooth curve, the sunspots appearing sometimes singly and sometimes in large groups in an erratic manner, but with ever-increasing frequency as the maximum approaches. Some general effects have been fairly well established, however, and to understand them we must briefly consider the mechanism of short-wave propagation in the ionosphere.

There exist at least two well-defined layers in the ionosphere, the upper, or F layer, at a height of about 180 miles above the earth, and the lower, or E layer, at a height of about 60 miles. Because of the pronounced diurnal variations in both the layers, it is evident that the sun is the main factor in their production. And, since they enclose the whole earth, as it were, in a shell, it would appear that they are caused by some solar agent which is not deflected by the earth's magnetic field. It is thought that there are two of these agents, namely, ultra-violet light, and neutral corpuscles which have been ejected from the sun, and both play their

part in the production of the two layers.

As the F layer is the one which is subjected to the greatest amount of solar radiation, the density of the free electrons in it is higher than that in the E layer, and because of the low gas pressure existing at this height the rate of recombination of the electrons and positive ions is comparatively low. Whilst the density of free electrons in the E layer is lower, the recombination rate is much higher owing to the higher gas pressure at this height. Thus we see that when the sun's action has been removed from the layers the degree of ionisation will fall rapidly in the E layer and comparatively slowly in the F.

Radio waves above about 3 Mc/s in frequency are propagated by means of refraction or "bending" in the F layer, the amount of bending depending, among other things, on the frequency used and the density of free electrons in the layer. Some other effects also occur, but we need not consider these here, merely remembering that the amount of bending is proportional to the density of free electrons, and inversely proportional to the square of the frequency of the wave. But before reaching the F layer the wave must pass through the E. Here the density of free electrons is not normally sufficient to cause enough refraction to return the wave, but in its passage through the layer the wave becomes attenuated to a degree depending on the free electron density and on the frequency.

Effect of Sunspots

Thus we see that for any particular frequency there are two separate conditions which can cause poor reception: (a) inadequate bending in the F layer, due to a

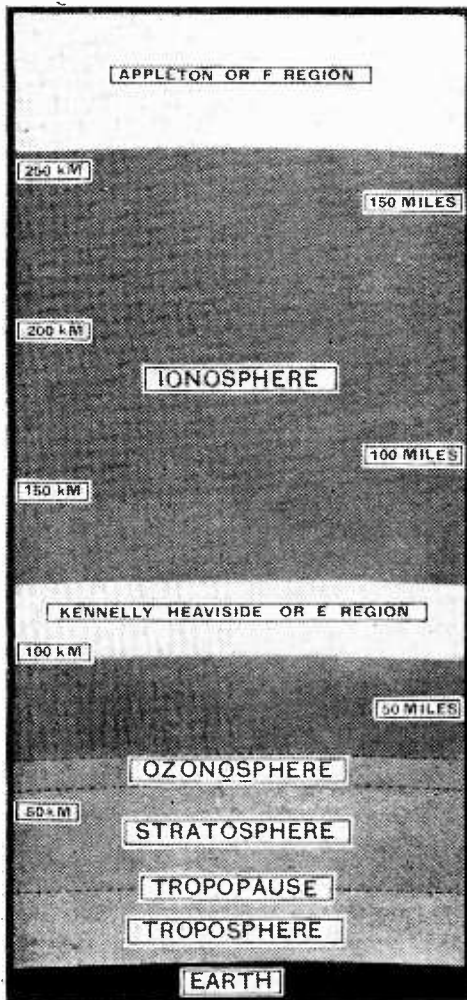

The various strata in the atmosphere with their relative heights and dimensions are shown in this illustration.

Short-Wave Listener

too low ionisation level there; and (b) excessive attenuation of the wave, due to a too high level of ionisation in the E layer.

On days when there is a large number of sunspots radiation of the ionising agents from the sun increases. These occasions become more frequent and the effect increases in intensity as the sunspot cycle proceeds towards its maximum, and consequent upon this the levels of ionisation in both layers become higher. According to Professor Appleton they are at present 300 per cent. higher in the F layer and 50 per cent. higher in the E, than in the minimum period.

For short-wave propagation over a daylight path the optimum frequency is shifted towards the higher frequency end of the spectrum. Notice that "the band of frequencies for good reception" is not entirely controlled by the F layer ionisation level, but to a great degree by that of the E layer, which is largely responsible for the attenuation of the wave. In other words, while there is an upper limiting frequency for adequate bending in the F layer, the lower limiting frequency is that for which the attenuation in the E layer becomes excessive.

To see an example of the effect of solar activity on a daylight transmission path, one has only to note the frequencies now being employed in the B.B.C. Empire Service. To secure good propagation over a very long daylight path during sunspot

minimum years a frequency in the region of 15.14 Mc/s was suitable. But to serve the same part of the world at the present time the B.B.C. uses a frequency of 21.47 Mc/s, since the former frequency, while being adequately bent in the F layer, would suffer such severe attenuation in the E layer that it would not provide the best signal possible for the area in question. There are signs, in fact, that higher frequencies still may be necessary before the maximum is reached, as it is evident that on days of exceptionally high solar activity even this high frequency is suffering heavy attenuation.

Dark Transmission Paths

Somewhat different sunspot effects occur when the transmission path passes into the night hemisphere. Short-wave listeners will often have noticed that on certain evenings, long after darkness has set in, while the stations transmitting on the normal night-time frequencies commence to come in, those which remain on the higher frequencies still continue to be well received. In other words, the frequency band for good reception is considerably broadened, and the effect may last up to midnight, at the mid point of the path. It is as though the earth at some point on the transmission path were still being illuminated by the sun's rays, and the effect is, indeed, due to a solar cause. It may be assumed that the sun is

in a state of high activity, and during the day this has led to a high degree of ionisation in both layers. After dark the ionisation level in the E layer rapidly falls, owing to recombination of the electrons and positive ions. Thus its attenuating effect upon the lower frequencies is decreased, and they reach the F layer, undergo refraction, and return to the earth without excessive loss of energy. Owing to the much lower gas pressure in the F layer, the rate of recombination is much lower there, and the abnormally high residual ionisation permits of adequate bending of the higher frequencies, which also continue to be well received. It is thought that the F layer recombination process may be further retarded after dark by bombardment of the outer ionosphere by streams of charged corpuscles ejected by the sun. These are concentrated towards the poles by the action of the earth's magnetic field, so that the effect is most noticeable on transmission paths in the night hemisphere which pass near to polar regions. As the *optimum* frequency is that which suffers least attenuation while being adequately bent, it follows that it is shifted up, as was the case in daylight, for it must be remembered that attenuation occurs in the F layer as well as in the E.

Bright Hydrogen Eruptions

It will be noticed that of the above effects due to increased activity, the first is not a detrimental one if certain modifications are made, while the second is definitely beneficial to short-wave propagation. High sunspot activity sometimes produces, however, a third effect and one which is always detrimental. This is

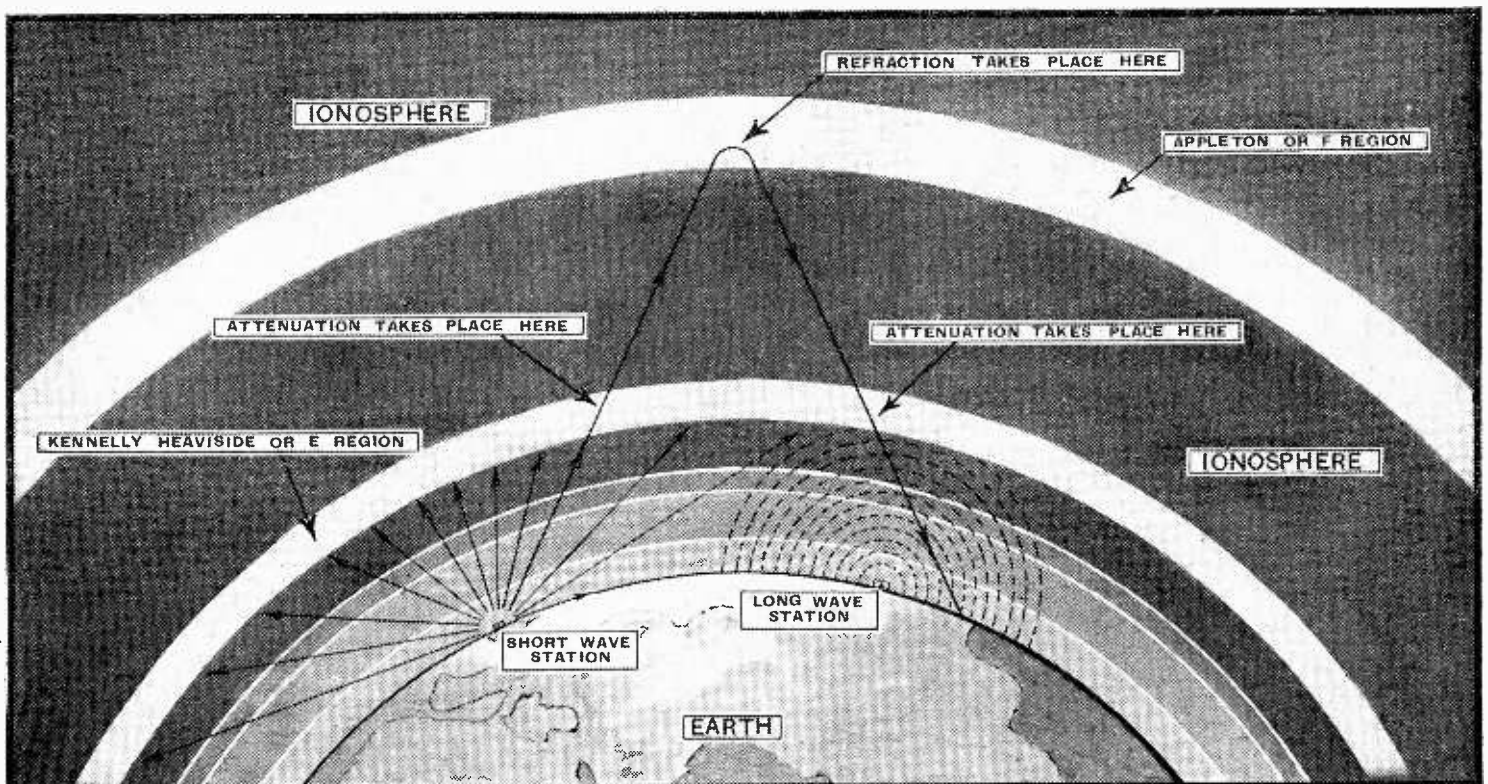

A pictorial illustration of the paths followed by the long and the short waves in the upper regions of the atmosphere. Only one short-wave ray is shown with an angle of incidence sufficiently oblique to be returned to the earth.

Sunspots and the Short-wave Listener—usually confined to daylight transmission paths, where there sometimes occur what are known as Dellinger fade-outs, during which all signals on the short-wave bands suddenly fade out more or less completely. These fade-outs may last as long as forty-five minutes, after which all frequencies are gradually restored to normal, signals on the highest frequencies being the first to reappear. It is now almost certain that they are closely connected with the sudden ejection of hydrogen by the sun. These bright hydrogen eruptions are associated with sunspots on the sun's disc, and have been observed by astronomers on at

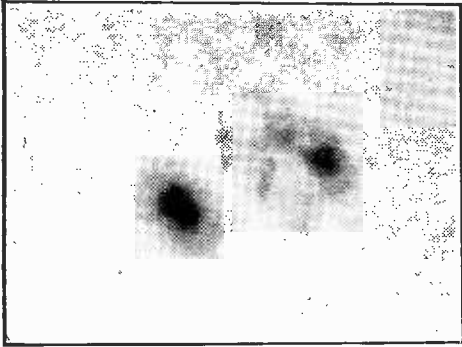

Close-up of a sunspot group.

Photograph by courtesy of the Journal of the British Astronomical Association and with the permission of the Royal Observatory, Greenwich

least eight occasions at the same time that a Dellinger fade-out was in process on the short waves. The fact that the fade-outs were observed to commence at the same time as, or very shortly after, the beginning of the eruption, and to cease shortly after its cessation, indicates that some agent travelling at the speed of light was being radiated by the sun during the eruption. It is thought that this agent is ultra-violet light, which causes a sudden excessive rise in ionisation in the ionosphere (probably the E layer), such that all frequencies in the short-wave spectrum become completely attenuated. It is interesting to note that when these fade-outs occur propagation conditions for very long radio waves are improved. These waves are not propagated in the form of rays, but by plane propagation of the transmission line type between the earth and the E layer. It is thought that the improvement is due to the big increase in conductivity in the E layer, brought about by the rise in ionisation levels.

Summarising the practical effects of high sunspot activity as far as the short waves are concerned, we may say:—

- (1) On days of high activity the ionisation levels in both layers are raised.
- (2) Due to the high gas pressure, the E layer level rapidly falls after dark, but the F layer ionisation persists at a high level.
- (3) Due to (1), the optimum frequency for daylight paths is raised.
- (4) Due to (2), the frequency band for good reception over a darkness path is much broadened, but the optimum frequency for the path is also raised.
- (5) Bright hydrogen eruptions occurring in association with sunspots cause imme-

diately excessive rises of the ionisation levels, resulting in Dellinger fade-outs.

Meanwhile, the approaching sunspot maximum is being watched with great interest, not only by astronomers, scientists, and radio transmission engineers, but by numbers of enthusiastic short-wave listeners and amateur transmitters throughout the world. T. W. B.

News from the Clubs

Croydon Radio Society

Headquarters: St. Peter's Hall, Ledbury Road, S. Croydon.

Meetings: Tuesdays at 8 p.m.

Hon. Pub. Sec.: Mr. E. L. Cumbers, 14, Campden Road, S. Croydon.

An entertaining evening was recently spent by the Society in which various aspects of home construction were described. Mr. H. T. Stott, a guest lecturer from the Ilford Radio Society, gave a talk entitled, "Modern Components." On a subsequent evening Mr. J. H. Owen Harries, the well-known valve expert, gave an interesting talk on the design of valves.

International DX'ers Alliance (London Chapter)

Headquarters: Chequers Restaurant, Essex Street, Strand, London, W.C.2.

Meetings: Monthly.

Hon. Sec.: Mr. J. Knight, 6, Fleetwood Street, London, N.16.

The London Chapter has just commenced publication of a new journal entitled "Amateur radio news compiled from the reports of members in all parts of the globe.

The commencement of the "London and Home Counties Short-Wave Cup Contest" brings the number of competitions now open to British members up to five.

Southall Radio Society

Headquarters: The Three Tuns Hotel, The Green, Southall.

Meetings: Tuesdays at 8.15 p.m.

Hon. Sec.: H. F. Reeve, 26, Green Drive, Southall.

One of the most interesting lectures of the season was recently given by Mr. F. Charman, G6CJ, on the "Propagation of Radio Waves." On a subsequent evening Mr. J. J. Maling, G5JL, exhibited and described a transmitter of his own design.

As a result of a lecture recently given on the amateur radio movement by Mr. J. Clarricoats, G6CL, the Secretary of the R.S.G.B., the Society has decided to become affiliated to the R.S.G.B. Mr. Clarricoats has generously agreed to meet the fees payable in connection with this.

At the annual general meeting it was announced that new and more spacious headquarters had been obtained, this being necessitated owing to the large increase in the Society's membership during the past three months. The new meeting place will seat 150 people. New officers were elected for the coming year.

The International Short-Wave Club

The recent annual dinner was attended by short-wave listeners from all over the British Isles. The American Consul was present, and also representatives of the radio manufacturers.

Nottingham Amateur Radio Society

Headquarters: 2, Bridford Road, West Bridford, Nottingham.

Hon. Sec.: Mr. C. Lambert, 199, Sherwood Street, Nottingham.

At a recent meeting Mr. S. Ingram, B.Sc., of Messrs. Belling and Lee, Ltd., gave a lantern lecture on "Aerials and Interference," which members declared to be one of the most interesting and instructive of the session.

Wirral Transmitting and Short-Wave Club

Headquarters: King's Square Café, Birkenhead.

Meetings: Last Wednesday in the month at 7.30 p.m.

Hon. Sec.: Mr. J. R. Williamson, 49, Neville Road, Bromborough, Birkenhead.

At the recently held annual general meeting it was stated that membership had increased tenfold during the year. Among the members were four fully licensed amateur transmitters and nine with artificial aerial licences. New officers were elected for the ensuing year. It was decided to hold an ultra-short-wave field day in July.

Halifax Experimental Radio Society

Headquarters: Friendly and Trades Club, Room 13, St. James' Road, Halifax.

Hon. Sec.: Mr. J. B. Bedford, Oak House, Triangle, near Halifax.

Mr. C. Berg, of Alkum Storage Batteries, Ltd., Halifax, recently gave an instructive lecture on the alkaline battery. Research work began in Sweden in 1893, and it took 16 years to produce a practicable article. Particulars were given both of the nickel-iron and nickel-cadmium batteries, and various practical examples, such as the Milnes H.T. unit, were described.

Exeter and District Wireless Society

Headquarters: Y.W.C.A., 3, Dix's Field, Southernhay, Exeter.

Meetings: Mondays at 8 p.m.

Hon. Sec.: Mr. W. J. Ching, 9, Sivell Place, Heavitree, Exeter.

In his talk on modern telephony methods, Mr. Bateman, of the G.P.O. Telephony Department, first traced the history of the telephone from the time of Graham Bell and then passed on to the modern telephony system. The lecturer also dealt with the work of cable ships in searching out and repairing breakdowns.



MARCONIPHONE "MASTER GRAM"

In this comprehensive instrument are incorporated a complete television receiver, a 4-waveband all-wave chassis and an automatic record-changing gramophone. The television image is viewed through a 45-degree mirror and a concealed lamp illuminates the television control panel. To be known as the Model 703 this latest addition to the Marconiphone range costs 120 guineas. This price includes a special television dipole aerial which will be installed free of charge.

CURRENT TOPICS

Prison Radio

A COMPLETELY new wireless installation has been put into operation at the Michigan State Prison at Jackson. Three programmes are available in each of the 4,000 cells.

Canada's Highest Aerial

THE recently erected aerial mast of the CJRC station in the vicinity of Winnipeg is the highest in Canada. At the base it is 32ft. square and tapers upwards for 404ft. to an area of 22 square inches.

Parachute Radio

ON Sunday (April 25th) M. René Vincent, a well-known figure in French aeronautical circles, will give a running commentary while descending in a parachute. The transmitter will be carried in a special rucksack.

The Coronation in West Africa

A COMPLETE network of permanent public address equipment is being erected in various centres in West Africa. This network will contain a total of over 5,000 loud speakers and will provide the Government with a powerful propaganda weapon among the natives. It is hoped to complete it in time for the Coronation broadcasts.

New Training Institution

THE proprietors of the well-known wireless school at Colwyn Bay have now transformed Loperwood Manor, near Southampton, into a residential training establishment for operators and engineers. The new school, known as the Wireless College, Calmore, Southampton, is situated in pleasant country surroundings, with its own playing fields, and can accommodate 150 resident students.

Cooper's Hill War Memorial Prize

WIRELESS engineers who are under 35 years of age and who are corporate members of the Institution of Electrical Engineers have a chance this year of winning the above prize, which is awarded triennially by the Institution for the best paper on a professional subject.

It was founded by members of the Royal Indian Engineering College, Cooper's Hill, in memory of those of their number who fell during the War, and consists of a monetary

prize of the value of about £20 in addition to a bronze medal and a parchment certificate. Papers must be sent in not later than October 1st, 1937.

Radio-controlled Targets

IT is reported that a great deal of experimental work is being undertaken by the French naval authorities in connection with marine targets controlled by wireless. A special wirelessly controlled "battleship" which is to be used for target practice is in course of construction.

Signals from the Stratosphere

SOME interesting investigations have been carried out by the U.S. National Bureau of Standards into meteorological conditions in the stratosphere. Several small balloons fitted with self-registering meteorological instruments, and an automatic radio transmitter were released. Messages were received from considerable distances. The whole apparatus including the meteorological instruments weighs only 20 oz. This was made possible

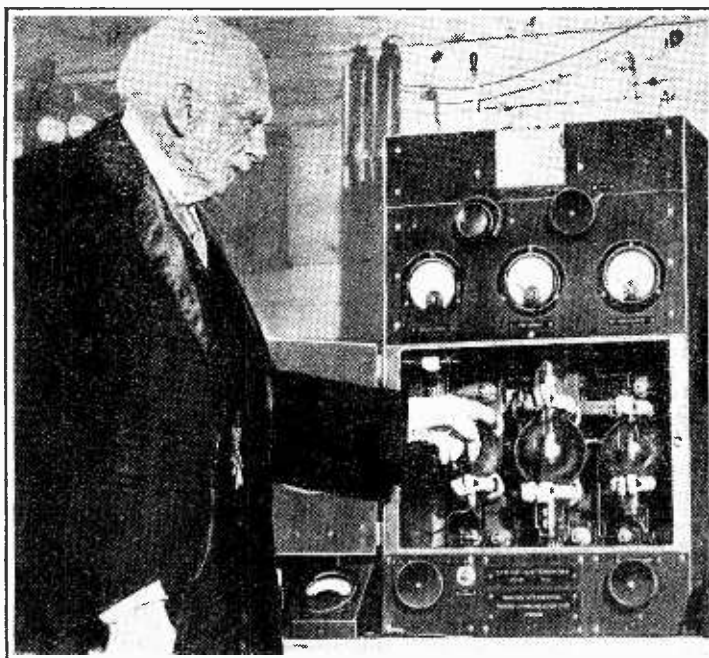

SIR AMBROSE FLEMING, doyen of valve technicians, at the new Wireless College, Calmore, Southampton, where he performed the opening ceremony last week. Sir Ambrose is examining one of the transmitters installed for instructional purposes.

International SW Congress

FROM July 12th to the 17th there will be a special congress held in Vienna to consider short waves in their relationship to physics, biology, and medicine. The Marchese Marconi, Professor D'Arsonval, and Dr. Zenneck will be Presidents of Honour.

200 Metres and Down

UNDER the above title a book has been written by the Assistant Secretary of the American Radio Relay League, in which are described instances in which wireless amateurs have used their skill in an emergency for the service of their fellow-men. These incidents are being put into dramatic form and broadcast by WMAQ, the well-known NBC station. One incident is dealt with every week.

by the development of a super-lightweight 45-volt H.T. battery weighing 2 oz.

Police Radio Progress

THE success which has attended the use of a local radio service by one or two police forces has, it is reported, led to the appointment of a special adviser on the subject by the Home Office. In all probability every police force will eventually be equipped with radio and a large national network formed.

Auto-alarm Protest

GRAVE doubts have been expressed by American marine wireless operators concerning the efficacy of the automatic alarm device which, as reported recently in *The Wireless World*, is to be fitted to all American

NEWS OF THE WEEK IN BRIEF REVIEW

ships carrying a generator. The President's American Radio Telegraph Association has sent a strong letter to the Federal Communications Commission in which he contends that the reliability of the auto-alarm has not yet been sufficiently proved.

No Danish "Radio Times"

THE proposal of the State Broadcasting Service of Denmark to publish an official programme paper has been abandoned as the result of a strong protest by Danish newspapers. The opponents of the idea state that the official programme papers published in other countries do not set an example worth following.

Trouble with AC Clocks

WHEN the electricity supply mains of Los Angeles were switched over to the new Boulder Dam Power Supply Station thousands of the city's domestic clocks—which are mainly of the synchronous type—commenced to gain. This was due to the fact that the new supply was of a slightly higher frequency than the old. The municipality is now engaged in the task of converting more than 125,000 clocks to the new frequency. AC mains receivers were, of course, not affected by the slight increase in frequency.

Questions in the House

OF the 4,168 wireless pirates prosecuted in the year ending February 28th, 1937, only seven were found not guilty, according to the P.M.G.'s reply to a question in the House. No motorists were prosecuted for failure to take out the additional licence necessary for car radio. In reply to another question, the P.M.G. said that the Television Advisory Committee would consider whether an additional licence was advisable in respect of a television set as soon as sufficient experience has been obtained concerning the cost of the television service.

Coronation Cavalcade

THE glamour of British State Pageantry is reflected in an admirable and dignified work of reference which Messrs. John Player and Sons have just prepared in the form of an album specially planned to take the new Coronation series of 50 cigarette cards. It is obtainable for 3d. from most tobacconists.

Television Interference Test Set

PORTABLE EQUIPMENT
TO BE USED BY
THE POST OFFICE
RADIO BRANCH

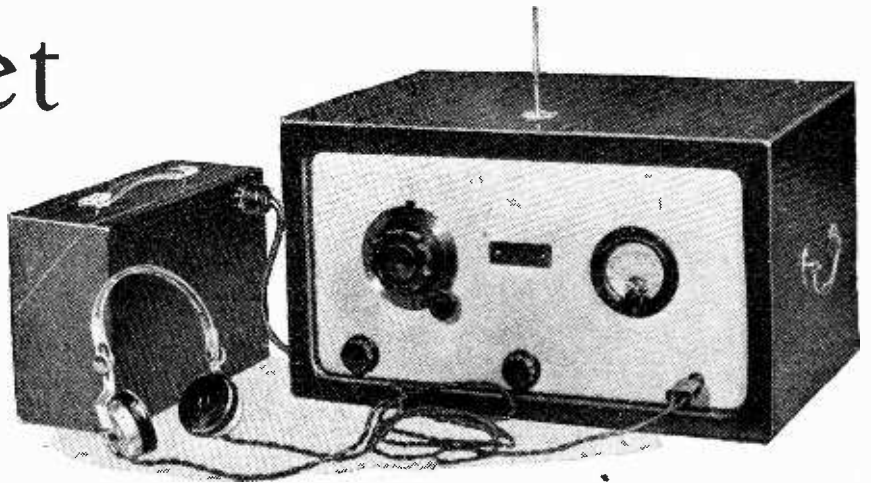

Portable ultra-short-wave superheterodyne for interference tests. The batteries are contained in a separate case.

THE investigation of interference on the wavelengths normally used for television reception is a problem now being tackled by the Radio Branch of the Post Office. Such investigation calls for different equipment from that used for the same purpose when the longer wavelengths are being examined. The chief sources of interference are from motor car ignition systems, electro-medical apparatus, thermostats, and electric motors.

A special ultra-short wave superheterodyne has been constructed for the Post Office for this purpose by British Television Supplies, Ltd., to whom we are indebted for the details.

The receiver has been designed to provide headphone reception of the Alexandra Palace transmissions throughout the service area on a 4ft. vertical aerial, and is operated from batteries. The circuit arrangement employs the following combinations: An octode frequency changer with separate triode oscillator fol-

lowed by three variable- μ pentode IF amplifiers feeding a diode triode which is transformer coupled to an output pentode of the low-consumption type.

Circuit Employed

The frequency range covered is 40-60 megacycles, and the input and oscillator circuits are ganged to give single dial control. The octode has the signal input fed into the usual oscillator grid, while the normal control grid is used for injection. The oscillator triode has a grid top cap providing low valve capacity, which is necessary at the frequencies involved. The three IF stages are tuned to 4 megacycles and arranged to provide a band-

width of 50 kc/s. The diode triode circuit is of interest, as a meter to provide an indication of signal strength is included here in the following manner: The rectified signal voltage developed across the diode load resistance is applied directly to the grid of the triode without the interposition of a blocking condenser, so that when the receiver is tuned to a carrier wave the anode current is lowered from its normal value.

The illustration shows the milliammeter, which is connected in the anode circuit mounted on the front panel.

Resistances in the negative HT lead provide grid bias for the output pentode and also the variable- μ IF valves. The latter is variable and is controlled by the lower left-hand knob in the illustration, while the lower right-hand knob controls audio-frequency gain by regulating the input to the pentode. The on-off switch is incorporated in the headphone jack.

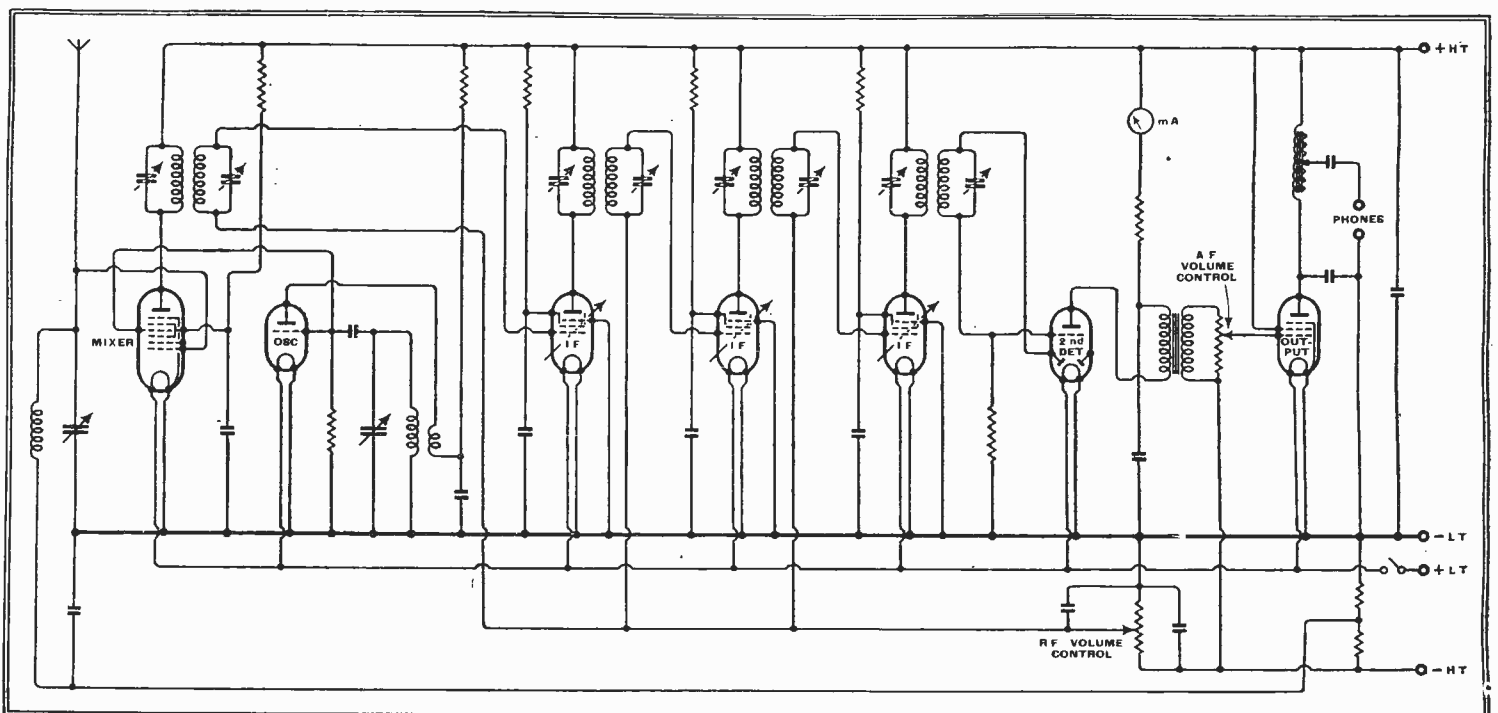

Theoretical circuit of the ultra-short-wave superheterodyne made by B.T.S. for the Post Office Radio Branch.

Television Interference Test Set—

The receiver is housed in a cabinet constructed of metal-faced plywood to provide screening, while a small separate box contains the HT and LT batteries.

The collapsible aerial, which consists of three lengths of $\frac{1}{4}$ in.-diameter brass rod screwed together, passes through a bush in the cabinet and screws into the small sub-panel which can be seen in the illustration. From the illustration of the chassis it can be seen that a layout providing short connections has been adopted, together with a mechanical construction to ensure rigidity and, therefore, constancy. Wherever possible, the metal parts have been welded together to ensure this.

The total weight of the receiver in cabinet is 28 lb., and the batteries in container weigh 16 lb. It is understood that ultra-short-wave field and interference voltage measuring apparatus is being developed by the Post Office, but until this is available receivers of the type described in this article will no doubt be of considerable use to the Post Office staff engaged in the localisation and suppression of interference with television reception.

Automatic Tuning Control

THE use of muting to ensure a "quiet" background when changing-over from one station to another is now becoming standard practice. The effect is pleasing to the ear, but tends to make the tuning somewhat critical. For this reason it often goes hand-in-hand with some form of automatic tuning control.

The object of providing ATC is to prevent any initial inaccuracy in the setting of the tuning knob from spoiling the quality of reproduction. Instead, the initial error is automatically put right, and the circuits brought back, gently but firmly, into true resonance.

Any slight mistuning of a superhet will naturally produce a beat frequency which is either slightly higher or slightly lower than that giving the required beat frequency for the IF amplifier. The latter, in most ATC systems, is coupled to a "balanced" rectifier, which develops a voltage of one polarity or the other, according to whether the initial setting is above or below the proper mark. This voltage is then applied to alter either the inductance or capacity of the local oscillator circuit, so as to change its frequency up or down until it comes into proper relationship with the signal. When this occurs the right beat frequency is being fed into the IF circuits and all is well. The tuning knob can be left where it is without playing ducks and drakes with the performance of the set.

Yet, a little reflection will show that whilst the automatic readjustment may work perfectly for one signal it will not be quite so accurate for a signal of either longer or shorter wavelength, because

then the same degree of mistuning will call for a slightly different value of the inductance or capacity required to bring the local oscillator back into correct step with the signal.

Philips (Patent No. 450664) tackle this somewhat elusive problem by providing a superhet receiver with two local oscillators instead of one, and throwing the onus of correction upon the second stage instead of the first. The point is that no matter what wavelength is being received, an initial error of say one degree on the tuning scale will produce a fixed frequency in the first IF circuit. As this is coupled to the second local oscillator, the latter thus has the advantage of always receiving a fixed input frequency, and it therefore produces a correcting voltage which is related only to this fixed frequency and to the original error in

fields of wireless and optics. The author wisely does not confine himself merely to definitions, and except in the simplest cases they are amplified by some description of the mode of operation of the circuit or apparatus.

A few errors have unfortunately crept in. In speaking of the deflectional sensitivity of a CR tube it is stated this is proportional to the voltage difference between the plates; actually, it is the deflection which is proportional to this voltage, not the deflectional sensitivity. In defining demodulation the author states that it is an alternative name for detection. It has this meaning in America, but it is more often used in this country to denote a decrease in modulation depth. The explanation given of diode detection is over-simplified, and incorrect since no account is taken of the profound effect of the load circuit impedance.

The description of a fader is more properly that of a mixer which, incidentally, does not find a place in the book, and the

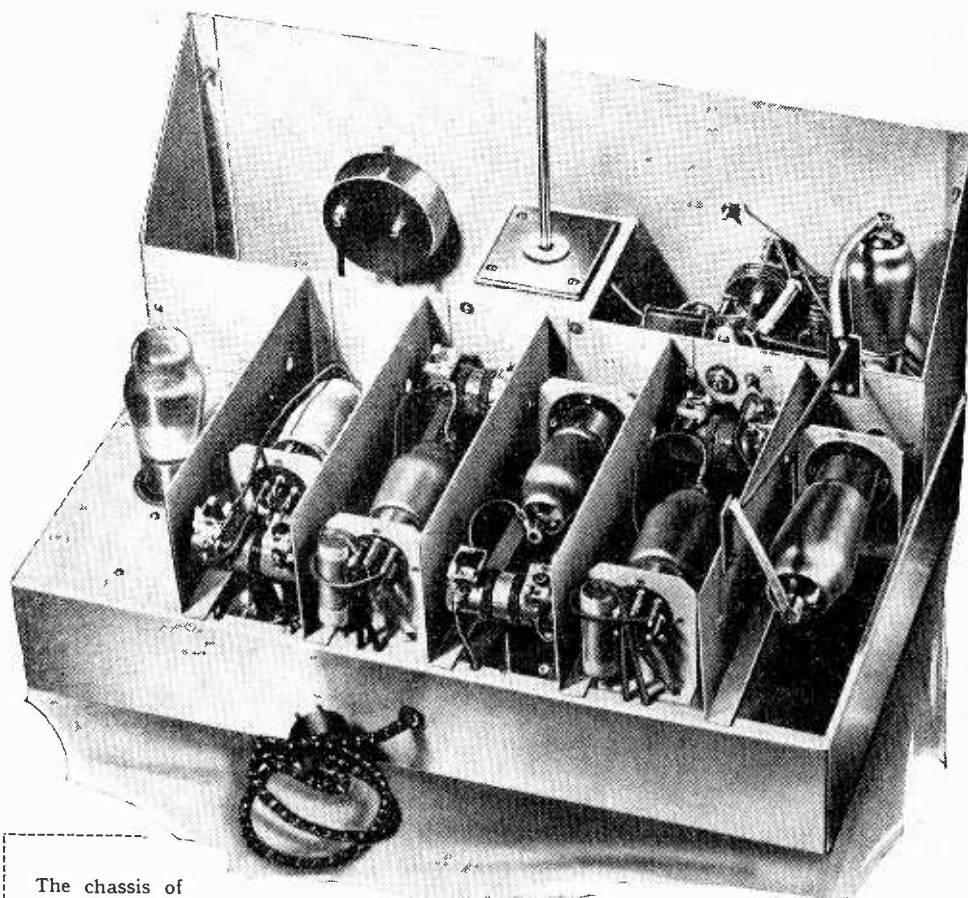

The chassis of the Television Interference Test Set removed from its case. Note the compact lay-out of the IF amplifier shown in the foreground.

tuning: In other words, the automatic tuning control is made equally effective whether the error it has to correct occurs at the top or the bottom of the wavelength scale.

BOOK REVIEW

Television Cyclopedia. By Alfred T. Witts. Pp. 151. Published by Chapman and Hall, Ltd., 11, Henrietta Street, London, W.C.2. Price 7s. 6d.

AS its title implies, this book contains definitions of terms commonly used in television practice and thus naturally includes many expressions which originated in the

definition of Miller Effect is wrong. The definition is "The name given to the action of a thermionic valve that causes the effective input impedance (grid-cathode impedance) to vary"; also ". . . when the load impedance is capacitive the resistance (input) becomes negative." There are other things besides Miller Effect which cause the input impedance to vary—electron transit time, for instance—and a capacitive anode load impedance does not make the input resistance negative. An inductive load impedance is necessary.

These errors in definitions naturally form a blemish upon a book which contains a large number of definitions of which the great majority are accurate and concise. The newcomer to television, who is naturally unfamiliar with its special vocabulary, should find the book of great help. The correction in subsequent editions of the errors referred to will make it more authoritative. W. T. C.

Murphy

ALPHABETICAL TUNING AND SHORT-WAVE CIRCUITS OF UNUSUAL INTEREST

IN designing this receiver the makers have set themselves the task of providing a performance on short waves which shall be comparable with that to which the majority of broadcast listeners have become accustomed on the medium-wave band. Hitherto the short-wave range has been open to criticism under three main heads: (1) Difficulty of tuning; (2) Susceptibility to image or second-channel interference; (3) Inadequate reserve of gain in view of the discrepancy in field strengths between medium- and short-wave signals taken as a whole.

In conventional "all-wave" receivers the first of these difficulties is met by mechanical means associated with the tuning condenser drive, but in the new Murphy set the solution is an electrical one and takes the form of a well-thought-out double frequency-changing circuit



A36

FEATURES.—Type.— Superheterodyne receiver for AC mains. **Wave-ranges.** — (1) 13-50 metres. (2) 200-550 metres. (3) 900-2,000 metres. **Circuit.** — (Short-wave section):— Reflexed pentode RF amplifier and first AF stage—triode hexode frequency-changer (Medium- and long-wave section):— Triode pentode frequency-changer—pentode IF amplifier—double-diode second detector—pentode output valve. Full-wave valve rectifier. **Controls.**—(1) Tuning. (2) Short-wave band selector. (3) Volume and on-off switch. (4) Wave-range. (5) Tone. (6) Noise suppressor switch. **Price.**—£15 10s. **Makers.** — Murphy Radio Ltd., Welwyn Garden City, Herts.

which virtually broadens out tuning on short-wave stations to medium-wave standards. In working out this circuit the designers have taken items (2) and (3) in their stride and the result is a receiver which is not only of absorbing interest to the student of technical details, but a set which, in the hands of the average listener, is likely to provide far more reliable entertainment than usual on the short-wave range.

The foundation of the circuit is a four-valve superheterodyne which is a logical development of the Murphy "26," "30" and "34" series. It has an input band-pass filter working on medium and long waves leading to a triode-pentode frequency-changer, pentode IF amplifier,

double-diode second detector and pentode output valve. The short waves are handled by a separate section consisting of a signal-frequency amplifier and triode-hexode frequency-changer. This unit has its own three-gang tuning condenser and signals are converted to an intermediate frequency falling in the medium-wave band of the main receiver. Thus the whole of the gain and selectivity of the broadcast receiver is available to supplement the already considerable signal with which it is fed from the short-wave section.

Now comes the most interesting feature of the design. Instead of keeping the

Complete circuit diagram. A separate RF amplifier and frequency-changer are used for the short-wave range and the resulting IF is taken by the medium-wave band of the normal broadcast receiver. The short-wave RF amplifier is reflexed to give additional AF amplification between second detector and output valve.

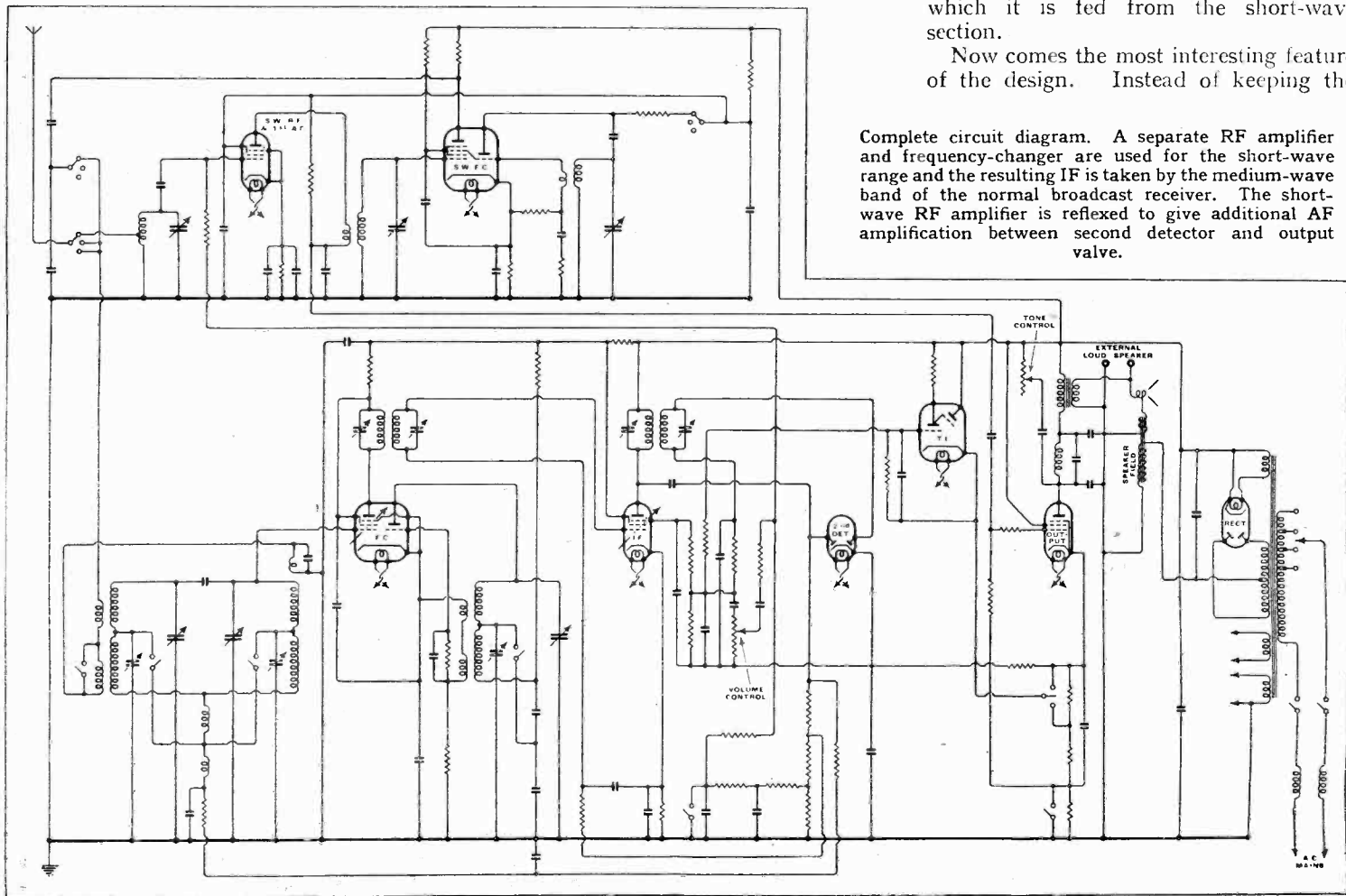

Murphy A36—

intermediate frequency fixed and varying the short-wave tuning circuits by some form of "vernier" drive, the short-wave tuning condenser is fixed by locating notches at predetermined points—actually the mid-points of the recognised short-wave broadcast bands—and the final tuning is carried out by the main tuning dial of the set. As the majority of the short-wave broadcast bands are less than 1 megacycle in width the short-wave stations in each band are spread out over the medium-wave dial and tuned with the same ease as medium-wave stations. The additional valves in the short-wave section bring the short-wave programmes up to the volume level of medium-wave stations and the additional pre-selection coupled with the high intermediate frequency entirely solves the problem of image or second-channel interference.

Theoretically, there is one snag. Signals at the extreme ends of any given band to which the short-wave tuning condensers has been temporarily fixed by the locating notch will be off-tune with respect to the peak of the resonance curve of the short-wave

nary way this would cause distortion not only for signals near the threshold, but also for strong signals which are deeply modulated. To overcome this difficulty an auxiliary diode is arranged to remove the noise suppression bias when a sufficiently strong signal is received. Actually the auxiliary diode is provided by the suppressor-grid-to-cathode circuit of the IF amplifier. A change is also made in the AVC delay, and when noise suppression is out of action AVC is increased by apply-

The drum dial is calibrated for sixty medium- and long-wave stations, and under average conditions good programmes should be obtained from 90 per cent. of these after dark and at a conservative estimate 40 per cent. in daylight. There is also a strong possibility that the list will be supplemented by other stations not marked, and a wavelength scale is provided at the top of the drum as a means of identification. The selectivity is adequate having regard to the require-

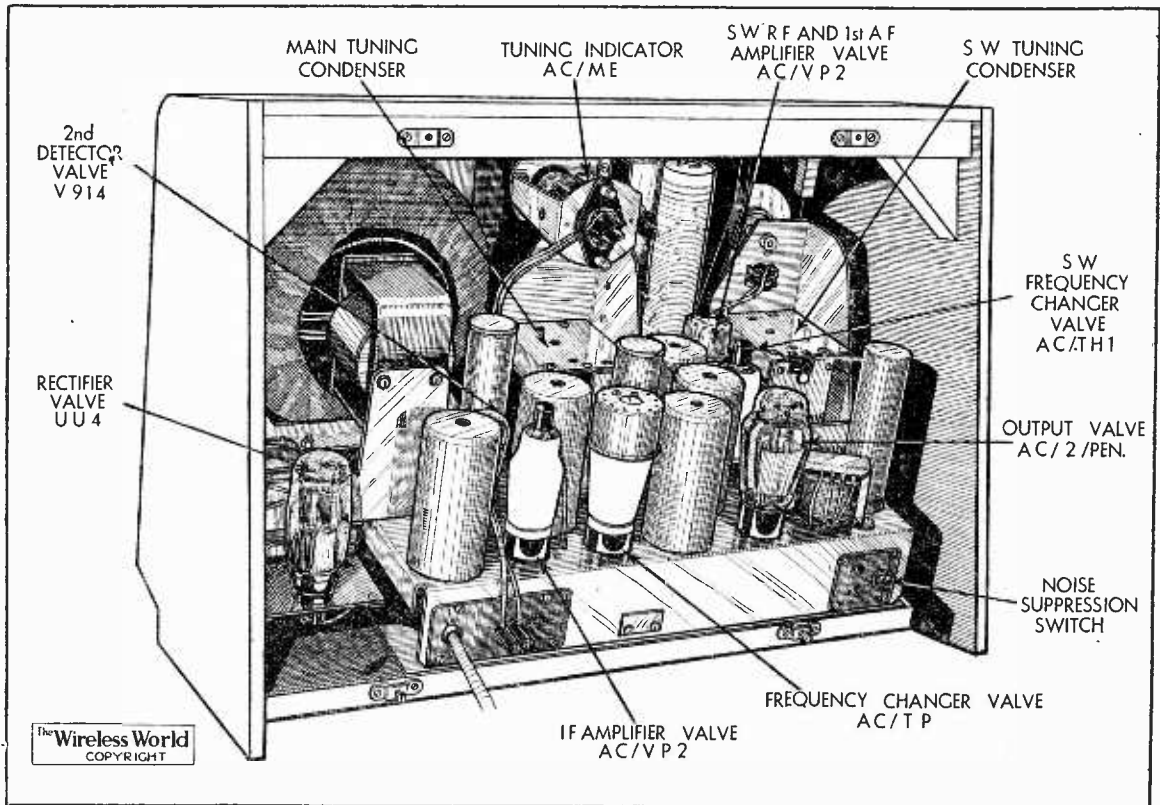

A separate three-gang tuning condenser is used for the short-wave range. Increased vane spacing is provided in the oscillator section of both condenser assemblies.

circuits and a reduction of input is to be expected. In practice any loss of signal strength or deterioration of image rejection from this cause is negligible. Sufficient over-all gain has been provided to give full volume from any worthwhile signals occurring at the extreme edges of the recognised short-wave broadcast bands, and any relative increase which may accrue from a station being near to the peak of the input resonance curve will be taken care of by AVC.

The circuit is as interesting in detail as it is in general specification. For instance, additional amplification is gleaned by reflexing the short-wave RF amplifier and pressing it into service also as an intermediate stage of AF amplification between the signal rectifying diode and the output valve.

The method of noise suppression is somewhat complicated, but the general principle of the circuit may be stated briefly as follows.

A paralysing bias derived from the cathode circuit of the output valve is applied to the signal diode. In the ordi-

ing a small degree of control to the reflexed valve.

Another refinement of interest is that the standing bias on the cathode-ray tuning indicator is automatically adjusted so that the same degree of selectivity is maintained whether the noise-suppression circuit is in or out of action.

Ease of Tuning

The intricacies of the circuit find no counterpart in the controls or their mode of operation. With the recently introduced "alphabetical" dial, tuning on medium and long waves is simplicity itself. Provided that a station is brought accurately to resonance (and with the sensitive cathode-ray tuning indicator to help there is no possible excuse for carelessness in this matter) the "identification disc" of the station falls exactly into position under the hair line, and by following the lead to the scale at the side the name is easily read off. Conversely, starting from cold, a station can be set on the dial with the certainty that when the valves warm up the transmission will be there and require little, if any, final adjustment. This is undoubtedly an advantage when things have been run fine at the start of the programme which one specially wants to hear,

ments of quality of reproduction, and approximately 1½ channels are lost on either side of the Brookmans Park transmissions when using the set at full gain in Central London. There is a commendable reduction of second-channel whistles, heterodyne interference and background noise in general below average standards.

It is probably because of the efficiency of the whistle filter in the anode circuit of the output valve that one's first impressions are of a somewhat deficient high-note response, but perhaps this is to some extent explained by the fact that the reproduction is free from the upper middle register resonances which are frequently called upon to provide a semblance of good high-frequency response. The loud speaker is of a new type with a curved-sided cone and handles the increased power output without any audible trace of amplitude distortion.

On the short-wave range it is difficult to decide which aspect of the performance is the more impressive—ease of tuning or the high volume level and steadiness of signals. No fewer than five American transmissions were received during a single afternoon, and on subsequent occasions Bound Brook and Schenectady were found to give a programme of exceptional volume and clarity whenever they were

Murphy A36—
tuned-in. Much better results than usual were obtained from Pittsburgh, 21.54 Mc/s (13.93 metres), and there was no evidence of any falling off of sensitivity on the 13-metre range which can often be levelled as a criticism of "all-wave" receivers of conventional design.

The newcomer to short-wave reception cannot fail to get good results right from the start, though he may be in the dark as to the identity of any particular station until he has heard an announcement. After he has become familiar with the settings of the principal stations he will be able to make use of a system of calibration which the makers have devised for more advanced listeners. At the top of the drum is a scale which is divided from 0—10. Actually this scale corresponds to a change of frequency of 1 megacycle and is quite accurate in calibration. Thus if the scale reading of a known "key" station is taken as a basis, the settings of other stations on that particular range can be found by addition or subtraction after reference to a list of short-wave stations giving their transmission frequencies in megacycles. The successful operation of this system depends upon the locating notch on the short-wave tuning condenser always being returned exactly to the same point, and in a new receiver it may be necessary to "settle" the short-wave tuning knob slightly to find the right position.

The mechanical details of the chassis are interesting. It goes without saying that the maker's reputation for neatness and sound workmanship has been maintained. Considerations of space and cabinet design have led to the mounting of the loud speaker, mains transformer and rectifier valve on a separate unit overhanging the edge of the chassis. Another unusual feature is the location of the output valve in the short-wave section of the chassis layout. Actually this is the logical position for this valve as it takes its input from the short-wave RF amplifier which has been reflexed to provide a first stage of AF amplification. In a receiver of this type special attention must be given to screening in order to avoid "pulling" of the oscillator, medium-wave pick-up when the short-wave range is in use and mains hum. As an indication of the care which has been taken in small details it may be mentioned that certain of the coupling components associated with the reflexed valve are actu-

ally mounted inside the screening cap on the top of the valve.

In spite of its somewhat belated entry into the field we believe that the A36 is a receiver which will have a marked influence on the future trend of commercial short-wave broadcast receiver design.

The Radio Industry

MR. M. K. TAYLOR and **Dr. N. H. SEARSBY**, both of the Ferranti Radio and Television Research Department, sailed last week in the *Queen Mary* for America. They will exchange information with representatives of the industry in that country, and are taking with them an example of the latest Ferranti television receiver.

Correx Amplifiers, Peckford Place, London, S.W.9, announces that, due to increased production, the Model W60 MG amplifier has been reduced in price from 70 gns. to 60 gns.

We learn from the G.E.C. that, in anticipation of Coronation broadcasts, an unprecedented demand from overseas has been experienced for receivers capable of receiving the Empire transmissions. Most of the sets to fulfil this demand are destined for South America, India, South Africa, and Malaya.

The increase of price of Film Industries productions is effective from April 1st, and not from May 1st as stated in last week's issue.

The Westinghouse Brake and Signal Co., Ltd., 80, York Road, King's Cross, London, N.1, have issued a useful and highly informative booklet on the use of Westinghouse Metal Rectifiers for electrical measuring instruments.

The Trix Electrical Co., Ltd., of 8-9, Clerkenwell Green, London, E.C.1, announces the introduction of two new portable universal amplifiers (Models U70 and U82). Model U82 is a complete 10-watt equipment arranged as a single unit, but with a demountable speaker.

Aladdin Radio Industries, Inc., 466, West Superior Street, Chicago, U.S.A., have issued a new booklet describing Polyiron coils of various types, and will send copies to anyone who is interested.

The business of Lectrolinx, Ltd., the sole proprietors of the well-known Clix specialties, will in future be conducted by a new company under the name of British Mechanical Productions, Ltd.

Articles dealing with the technical and commercial aspects of television are now included in "The Broadcaster" Trade Annual, of which the 1937 edition is now on sale at 5s. post free (trade circulation only) from 20, Bedford Street, Strand, London, W.C.2. The book contains much useful information for dealers and servicemen.

A Portable Level Meter, just brought out by the G.E.C.'s instrument works at Salford, embodies essentially an amplifier and a log-scale voltmeter of the rectifier type. The meter covers a wide frequency range and has many applications in audio-frequency work.

FERRANTI "837"

A NEW superheterodyne for AC mains has just been released under this title by Ferranti, Ltd., Moston, Manchester. The circuit employs a heptode frequency-changer, var.mu pentode IF amplifier and double-diode pentode combined second detector and output valve. Special attention has been given to selectivity, and second-channel interference on the short waveband is reduced by the employment of a 450 kc/s intermediate frequency.

The tuning scale is of the circular type, and the three waveranges are distinguished by different colours. An additional 180-degree scale enables exact settings of stations on all wavebands to be logged. The short-wave range is from 16.7 to 52 metres.

The price of the new set, which is housed in a bakelite cabinet, is 8 gns.

New Series of Marconi Valves

Fitted with Octal Bases and
6.3-volt Filaments

A NEW range of Marconi valves fitted with what is described as International bases has now become available. These valves have characteristics similar to the American G series, or glass equivalents of the metal range. Self-locating Octal bases are fitted, and the filaments of the valves in this series are designed for 6.3 volts.

The medium mutual conductance

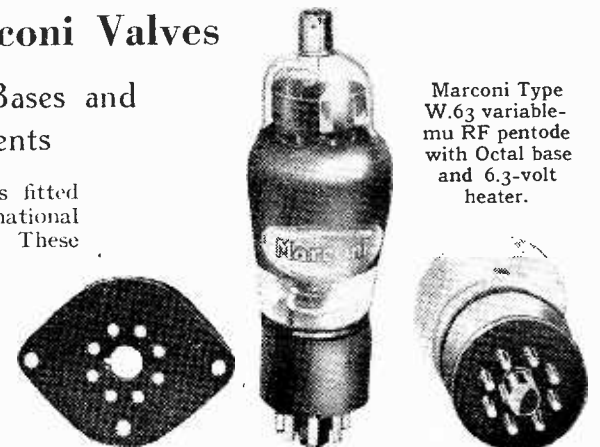

Marconi Type W.63 variable-mu RF pentode with Octal base and 6.3-volt heater.

Valve holder and Octal base are also shown.

MARCONI INTERNATIONAL RANGE.

Type.	Description.	Heater.		Volts.		A.C. Resistance (ohms).	Amplif. Factor.	Mutual Conductance (mA/V.).	Price.
		Volts.	Amps.	Anode.	Screen.				
X63	Heptode FC	6.3	0.3	250	100	—	—	0.5	15/-
W63	Var. Mu RF Pen. ..	6.3	0.3	250	125	—	—	1.5	12/6
Z63	RF Pentode	6.3	0.3	250	125	—	—	1.2	12/6
H63	Triode	6.3	0.3	250	—	66,000	100	1.5	9/6
D63	Double Diode	6.3	0.3	—	—	—	—	—	5/6
DH63	Double Diode Triode ..	6.3	0.3	250	—	58,000	70	1.2	12/6
N63	Output Tetrode	6.3	0.7	250	250	—	—	2.5	13/6
N66	Output Tetrode	6.3	1.27	400	300	—	—	6.3	25/-
U50	Full-wave Rectifier ..	5.0	2.0	350 + 350 Max. Rectified current 120 mA.					10/6

values of the valves allow for generous clearances in the electrode assembly, giving an increased reliability and high degree of consistency.

With but a few exceptions the current rating is 0.3 amp., which makes series operation possible in AC/DC sets, and the 6.3-volt heater is particularly well suited for car radio purposes. Thus the new series has truly universal application.

The principal characteristics and prices of the new Marconi International valves are given in the table.

BROADCAST BREVITIES

NEWS FROM PORTLAND PLACE

Pronouncing Przemysł

"BROADCAST English" is the more or less appropriate title of the B.B.C.'s "recommendations to announcers regarding the pronunciation of some foreign place-names." It is No. VI in the series of "recommendations," and will go down in history, perhaps, as the first effort in black and white to convince the English-speaking world that Mengtshhsien is pronounced "mungtschsyen" and Przemysł "pshemmissël."

A Courageous Work

In a word, it is a courageous publication, likely to set tongues wagging in Clubland and other places where they wrangle, but calculated to bring peace of mind to announcers for generations to come. Even now people quarrel over the pronunciation of Addis Ababa and Adowa, and the book tackles not only these but names which no one as yet has even begun to argue about, such as Anuradhapura and Pya-Pun. "Be prepared" is evidently the motto of the B.B.C. Advisory Committee on Spoken English, which sponsors the list, and to be absolutely on the safe side it also throws in a few old favourites like Amsterdam and Stamboul (formerly pronounced "Constantinople").

Jaws of Rubber

On paper the recommended pronunciations are not too terrifying, though it is obvious that the complete broadcast announcer must still have jaws of rubber. The difference, however, is that the names have been adapted for English jaws.

Announcers, Please Note!

As Fowler says in "Modern English Usage"—the passage is quoted by Professor A. Lloyd James in his preface to this book—"To say a French word in the middle of an English sentence exactly as it would be said by a Frenchman in a French sentence is a feat demanding an acrobatic mouth . . . it is a feat that should not be attempted. . . . Your collocutor, aware that he would not have done it himself, has his attention distracted, whether he admires or is humiliated."

Would that B.B.C. announcers always remembered this counsel!

Here, There and Everywhere

MAY 1st will probably be the most notable outside broadcast day, with emphasis on *outside*, in the history of the B.B.C.



An artist's impression of the imposing entrance to the Wireless Pavilion at the Paris International Exhibition.

First on the agenda is the commentary by George Allison and Ivan Sharpe on the great match between Sunderland and Preston North End at Wembley. Then the control room will switch over to Old Trafford, where Lancashire and Derby will be opening the cricket season, with P. G. H. Fender as commentator. The second and third day of this match will also come into the relative programmes.

Other Events

"Over," then, to Brooklands, where F. J. Findon will be describing the annual Brooklands Road Race. The next venue will be Bournemouth for the Annual Hard Courts Championship, where Mr. Cooper Hart will be the commentator. After that listeners will be taken to "somewhere south of the Mendips" to explore the Mendip potholes.

Finally, there will be two "O.B.'s" indoors, the final of the Billiards Championship at Thurston's, and "Tommy" Woodroffe will attend the Royal Academy, to describe a tour round the galleries, before the microphones come into circuit at the annual banquet itself for the presidential speech by Sir William Llewellyn.

The Spithead Review

ALTHOUGH B.B.C. engineers are in the throes of their elaborate arrangements for Coronation Day broadcasts to the world, they are simultaneously preparing for the technical requirements connected with the King's review of the Fleet at Spithead on May 20th. O.B.'s will have a short-wave receiving station at Southsea Castle, where commentaries will be received by line from the jetty from which the Royal yacht is to leave. The com-

mentary from H.M.S. Nelson will also be picked up at Southsea Castle by radio link, and the whole of the material sent thence by land line to Broadcasting House. In addition to the observers' microphones, others will be installed ashore and on H.M.S. Nelson for picking up atmosphere and effects. It will be a trying day for the B.B.C.'s microphones, what with the thunder of the guns, the roar of the engines of the Fleet Air Arm as the squadrons dip in salute, and in close formation dive over the Royal yacht.

More May O.B.'s.

EVEN if the Coronation broadcasts were omitted, next month will be a memorable one for outside broadcasts. On May 5th there is the Chester Cup, and on May 8th the Rugby League Final. The Coronation Cup polo match at Hurlingham will be broadcast on the 17th, and the international rink hockey match at Herne Bay on the day after.

B.B.C.'s First Staff Reporter

FIRST staff reporter to be appointed by the B.B.C., Frederick Grisewood, is now swotting up methods which he and his counsellors of the Outside Broadcast Department consider most suitable to his new calling. As the job develops it will become something more elaborate than that of the ordinary broadcast commentator, and will partake of the character of descriptive reports rather than the mere narration of incidents. The first really big event to be covered by Grisewood will be the description which accompanies the televising of the Coronation procession at Hyde Park Corner on May 12th.

Rocking the Ship

LAST week's problem at Alexandra Palace: Take one ship's deck—for Harry Pringle's cruising programme—and give it the appearance of rocking in a gentle swell. Neither the stage nor the camera must be moved.

A senior studio engineer took

home this problem for the weekend, and, after a bout of seasickness, returned on Monday with the perfect solution. Before reading further, see if you can guess what the solution was.

So Simple

What he did *not* do was to attempt an electrical method by slowly lifting the picture frame.

First he mounted the camera "broadside on" to the deck scene. About four inches from the lens he placed a mirror of post card size at an angle of 45 degrees, so that the scene was reflected into the camera. The mirror itself was attached to a wire rod, one end of which was held by a spring against an eccentric cam rotated by a carefully governed gramophone motor. The effect was to give a gentle rocking motion to the mirror. And that was all.

Coronation Highlights

GRACIE FIELDS has been booked for the B.B.C.'s Gala Concert on May 12th. . . . Jack Payne and his band will also be heard on Coronation Night. . . . Booking Department has also secured the Band of the 2nd Battalion Royal Scots Fusiliers.

India Calling the Empire

A FOUR-YEAR-OLD custom will be perpetuated on May 24th, when India and Ceylon provide the Empire Day programme for diffusion throughout the King's Dominions. The programme is now being devised by "A.I.R."—All-India Radio.

The first of these annual radio festivals was arranged by the B.B.C. in 1933. Australia followed in 1934, and the 1935 and 1936 concerts were given by Canada and South Africa.

UNUSUAL significance is given this Coronation Year to the festival of the patron saint of England. Dating as it does from before the Norman Conquest, and falling only a few days before the crowning of the King, it will serve as a timely symbol of our age-long heritage of patriotism. Special broadcasts in commemoration of this day will include the production by Val Gielgud of "King Arthur," devised and written by G. D. Bridson.

From the annual banquet of the Royal Society of St. George, the Lord Chief Justice, Lord Hewart, will be heard at 8.40 (Reg.). He is one of the most outstanding and wittiest of speakers. On this occasion he will propose the toast of England. At this annual celebration on England's patron saint's day, there is age-old and picturesque pageantry. "The Roast Beef of Old England" is ceremoniously brought into the banquet with

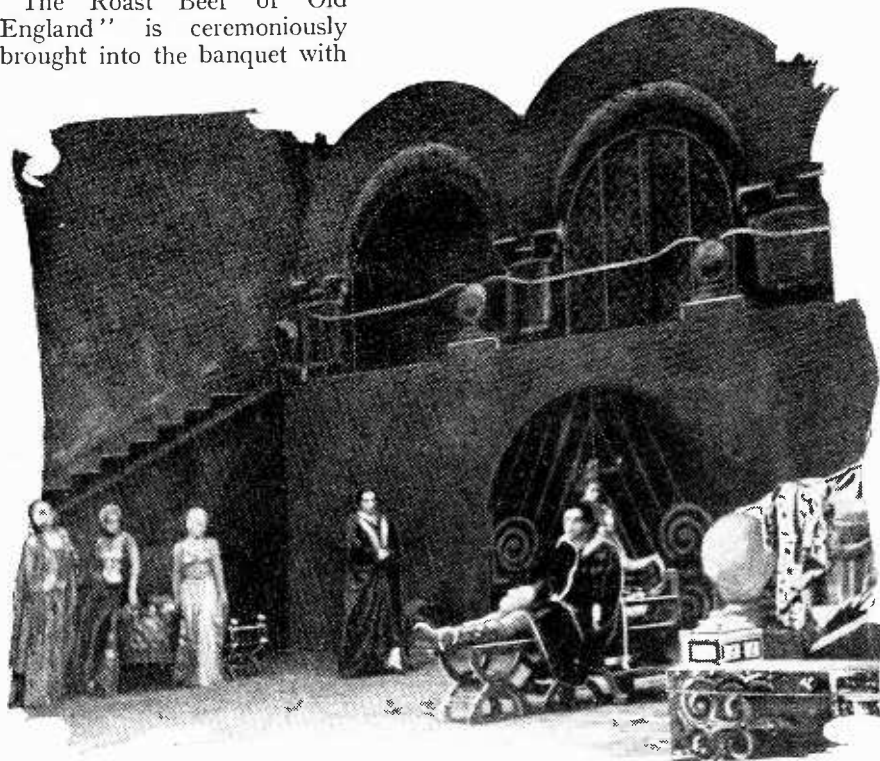

a guard of honour heralded by a band.

"King Arthur" will tell of the life and death of that great King who, with his Knights of the Round Table, typifies chivalry. Special illustrative music has been written by Benjamin Britten. This 23-year-old composer has already made a name for himself as a writer of choral and other works of great beauty. A distinguished cast has been collected for the production. Leon Quartermaine and Hilary Eaves will be heard as Arthur

Listeners' Guide for t

Outstanding Broadcasts at Home and Abroad

and Guinevere, while Esmé Percy will play Merlin, the wizard. A newcomer to the microphone is Griffith Jones, whom many will remember for his fine performances with Elisabeth Bergner in "Escape Me Never." He will play the part of Sir Lancelot. "King Arthur" will be broadcast Nationally at 7.30 to-night (Friday) and again Regionally at 8.30 on Saturday.

FROM COVENT GARDEN

THERE will be an important operatic relay from the Royal Opera House on Monday when the whole of "Ariane et Barbe Bleue" by Paul Dukas will be heard. This will be the first

TALKS

Two well-known and brilliant writers are broadcasting talks on Tuesday. The first in the Regional programme at 8.40, when H. V. Morton gives the first of two talks which are designed for Coronation visitors to London, the title of which is "Off the Route." No better speaker could have been chosen to initiate the visitor to London into the byways of the great metropolis than H. V. Morton, whose writings on London are so well known. Later in the evening, at 9.20 (Nat.), Compton Mackenzie will talk on "The First Things I Remember."

In the pamphlet on broadcast talks the illustration accompanying the note referring to this broadcast shows a wee Scots laddie looking up to a hand holding a large size in slippers. Compton Mackenzie has chosen the subject for his talk, and we can therefore be sure of a well-spent twenty minutes.

Although not strictly a talk, a discussion which

BLUEBEARD'S CASTLE.

A scene from Paul Dukas' "Ariane et Barbe Bleue" which the Opéra Comique Company is performing at Covent Garden. The whole opera will be broadcast on Monday.

National listeners will hear at 9.50 on Sunday should be of great interest as the topic is Sunday games. I need say no more, as it is always a debatable one.

CORONATION CONCERT

A GRAND CORONATION CONCERT in aid of the Musicians' Benevolent Fund will be broadcast from the Royal Albert Hall on Sunday at 2.30. The programme, an all-British one, will include "Coronation Flourish," by Arthur Bliss, which will be played by trum-

HIGHLIGHTS OF THE WEEK

FRIDAY, APRIL 23rd.
Nat., 7.30, "King Arthur." 9.20, The Budget: Lt.-Col. Colville. 9.30, "The Three Must-Get-Beers."

Reg., 6.30, Music of the Western Isles. 7.30, "Twinkle." 8.40, Annual Banquet of the Royal Society of St. George.

Abroad.

Budapest 1, 7.30, "The Rhinegold" (Wagner).

SATURDAY, APRIL 24th.

Nat., 3, "Twinkle." 5, Erith British Legion Band and Robert Easton. 7.30, ABC-C. 8, Music Hall including Alberta Hunter and Wee Georgie Wood.

Reg., 6, Seven-a-side Rugger Final. 7.30, The Railway Clearing House Choir. 8.30, "King Arthur."

Abroad.

Frankfurt, 8.10, Love in song, music and dance.

SUNDAY, APRIL 25th.

Nat., 2.30, Musicians' Benevolent Fund Concert. 5.30, Pianoforte recital: Brailowsky. 7.45, The Bishop of Chelmsford. 9.50, Discussion: Sunday games.

Reg., 5, The Eastbourne Municipal Orchestra. "Recital, Peter Dawson. 10, Melodies of Christendom.

Abroad.

Leipzig, 8, Excerpts from operetta and musical comedy.

MONDAY, APRIL 26th.

Nat., 7, The Music Shop—XV. "Towards National Health: Nutrition. 8.20, A revue: "Among Those Present." 10, Act III of "Ariane et Barbe Bleue."

Reg., 7.30, Cello recital: Lauri Kennedy. 8, and 8.55, Acts I and II of "Ariane et Barbe Bleue."

Abroad.

Radio Paris, 8.30, "La Vida Breve," opera (de Falla).

TUESDAY, APRIL 27th.

Nat., 7, Almonds and Raisins: Jewish variety. 9.20, Compton Mackenzie. 9.40, "The Little Show": a radio cabaret.

Reg., 7.30, Rhythm Music: the Theatre Orchestra. "Variety from the Concert Hall, Bournville. 8.40, H. V. Morton.

Abroad.

Warsaw, 8.15, Symphony concert.

WEDNESDAY, APRIL 28th.

Nat., 5, Prelude to cricket. 8, "East Lynne."

Reg., 6, Falkman and his Apache Band. 6.40, From the London Theatre. "I" "Swing that Music": the Ramblers band from Holland.

Abroad.

Munich, 8.45, "April Moonlight," operetta potpourri.

THURSDAY, APRIL 29th.

Nat., 6.40, B.B.C. Dance Orchestra. 8.40, "Words Fail Me."

Reg., 6, "East Lynne." 7.40, Western Salon: Chamber Music from Marston Magna, Somerset.

Abroad.

Paris, Eiffel Tower. 8.30, Excerpts from "Julien" (Charpentier).

Week

his ironic pen to Dumas' "The Three Musketeers," which title for his burlesque becomes "The Three Must-get-Beers." No guarantee can be given that John Dighton's story will follow accurately the lines of the classic. The famous character D'Artagnan will be played by Claude Hulbert under the name of D'Artcham-

"TWINKLE," a holiday show, will be produced by Clarkson Rose for listeners to-night and Saturday. He is here seen with his leading lady, Olive Fox. The Twinkle Company will again be at Eastbourne during the summer.

pion, while the three musketeers become Bathos, Pathos and Amorus, to be played by Bobbie Comber, Horace Kenney and Eric Anderson. Robert Ashley will double the parts of the Duke of Backgammon and the King of France. This will be the first occasion that this young singer has taken a dialogue part. This burlesque will be heard by National listeners to-night (Friday) at 9.30.

EAST LYNNE

TOD SLAUGHTER, king of melodrama, has adapted for broadcasting Mrs. Henry Wood's famous novel "East Lynne." This Victorian story

sold in its millions, and though it is now mainly interesting as a period piece, Tod Slaughter's play, with himself as Sir Francis Levison, the home-wrecker, should prove ideal for broadcasting. This will be heard by National listeners on Wednesday at 8 and Regionally on Thursday at 6.

OPERA FROM ABROAD

WAGNER needs no introduction to opera-lovers, and certainly not where his "Ring" is concerned. "The Rhinegold" is the great composer's preludial opera to that work which for grandeur and breadth of conception has no parallel in music—a work which occupied Wagner a full quarter of a century. The Royal Hungarian Opera has chosen "The Rhinegold" for to-day's (Friday) 7.30 programme, which Budapest 1 relays. Warsaw, too, announces a relay of its own Opera House programme at 8.15, when, contrary to the usual intense nationalistic aspect of Warsaw's opera broadcasts, the Austrian composer Kienzl's three-act "Der Kuhreigen" is billed. Kienzl resided for some time in Bayreuth as an intimate friend of the Wagner family, and all his work shows the constructive features of the Wagnerian creed.

The "high spot" of Saturday is undoubtedly the relay by Rome of the 9 o'clock programme from La Scala, Milan.

The opera chosen is Donizetti's "The Love Potion." It is interesting to note that December of last year saw the centenary of the opera's first performance in this country, which took place at the Lyceum Theatre on December 10th, 1836. It was while Caruso was singing the role of Nemorino at the Brooklyn Academy of Music in 1920 that he burst a small blood vessel in the throat—the first sign of his fatal illness.

Wagner is again on the air on Sunday, this time from Breslau, which bills his "Valkyrie" for 7.

Paris (Eiffel Tower) can count on a great concourse of listeners at 8.30 on Thursday, when the great modern French composer, Charpentier, conducts excerpts from his opera "Julien" at the Salle Gaveau. For the instrumental section one can be certain of perfection, the National Orchestra being billed. This opportunity of hearing one of Charpentier's unfamiliar operas performed in accordance with the composer's own ideas, is not likely to be missed.

TEAM WORK

AN interesting item portraying the team spirit with which the Scandinavian broadcasting authorities are preparing programmes will be relayed by all stations in Scandinavia from 8-9.15 on Saturday. It will consist of contributions in quick succession from Denmark, Norway, Sweden and Finland by leading variety artistes, the whole forming a complete radio cabaret.

FINNISH THEATRELAND

ALL the leading theatres in Helsingfors will be visited by the microphone to-night (Friday) at 7.10. This sequence of broadcasts will be followed by a Radio Revue which will continue until 11. All Finnish stations will be radiating this programme.

NEGROID MUSIC

POPULAR hot rhythm will be presented by a new Norwegian rhythm band directed by Pete Siwers over the Norwegian network at 8 to-night (Friday). The following evening at 8.45 Norway radiates Negroid music of a different style. The Drammen Mixed Choir and the Drammen Municipal Orchestra will be giving a recital of Negro spirituals.

THE AUDITOR.



peters. This will be its first performance. Muriel Brunskill and Harold Williams will be the soloists, and the concert is being given in co-operation with the Kneller Hall Military Band and fifty trumpeters from the Royal Military School of Music, the London Symphony Orchestra, the Royal Choral Society, and the B.B.C. Choral Society.

CABARET

"THE LITTLE SHOW," originated by Bryan Michie as a radio cabaret for broadcasting in the late evening, returns to the microphone on Tuesday in the National programme at 9.40. The Coronation season will bring to the "floor shows" of the big hotels the greatest cabaret artistes of the world, and it is Bryan Michie's desire to produce many of these famous acts in a series of "little shows." This week the artistes include Odette and Kay; Dim Drams and Georges Gladysky; and Walsh and Barker. The Variety Orchestra and the new combination within that orchestra known as "The Variety Swingers," will support the cabaret stars.

BURLESQUE

LISTENERS will remember John Dighton's successful burlesques of "The Scarlet Pimpernel" and "The Speckled Band." He has now turned



BILLY BISSETT, Canada's No. 1 band leader, looking over a new number with some of his band. He will be heard with his Canadians by Regional listeners at 10.25 to-night, playing from the May Fair Hotel.

Details of this week's Television programmes will be found on p. 409

About Push-Push

CURRENT CONSUMPTION DEPENDENT ON VOLUME

By "CATHODE RAY"

THE term "Push-push" is not in general use, probably because it sounds rather babyish. The only reason for using it at the head of this page is also rather babyish—it would be amusing to know how many readers thought at first glance that a previous title* had accidentally been duplicated. These two terms, like the names "Tweedledum" and "Tweedledee," have at least the merit that their similarity reflects the apparent similarity of the systems to which they apply, the difference sometimes being no more than the voltage of the grid bias. Yet although the circuit diagrams may be identical, this difference in grid voltage has rather far-reaching results.

I pointed out recently that the original push-pull circuit of 1915 was actually worked as push-push—each of the two valves taking turns to amplify alternate half-cycles of the signal wave—and that after gathering dust for a number of years this scheme was rubbed up a bit and offered to the public as QPP—Quiescent Push-pull. Incidentally, I believe it was a design of mine that was actually the first to be put on the market in 1930. Any rival claimants? A still more faithful copy of the original patent appeared a little later as Class "B"—one of those strange American names that everybody is compelled to accept and use, as the rabbit is compelled by the eye of the snake to stand to attention. Class "B" is now, I believe, generally understood to refer to any system in which the working point of the valves is at or near the anode current cut-off point, or bottom bend of the characteristic curve, whether that result is obtained by using more than normal grid bias or by special design of valve. But when Class "B" is mentioned in contrast to QPP it means the special valve system as distinct from the over-biasing system.

Economy in Anode Current

The original object (in 1915) was to overcome a defect in the valves then available; the revival occurred at the point in history when the design of valves had progressed so far as to enable them to fill a room with sound without being hopelessly overloaded. The fact that they drew a lot of current in order to do so was unim-

portant, or not, according as they were mains driven or battery driven. To supply a pennyworth of mains power by batteries costs £1, so it does make a difference. Mains volume from battery power either costs exorbitantly or else something must be done to employ the power more economically.

The first idea that occurs is that the current drawn by the ordinary power valve is calculated on the basis of the top-most peak of the fiercest climax of the loudest programme ever to be heard. That occupies only a matter of seconds, perhaps, in weeks of listening. Most of the time the volume is turned down (next door neighbours may challenge this statement, of course), and the programme is relatively quiet, and often it ceases entirely while we are waiting for the next one to come on. During this time anything up to 100 per cent. of the power going into the valve is being wasted. What is wanted is a system in which the

risers correspondingly. That is what was called QPP, and although pentodes were and are generally used for it they are not essential.

The reason why they are used in preference to triodes comes into the second economic principle. It is not enough to make sure that battery power is being used only in proportion to the volume of sound created; the next thing is to see that, whether the volume is much or little at any moment, it is efficiently produced.

Triode versus Pentode

The efficiency of a small triode valve, even when working to full capacity, is generally no more than about 20 per cent.; for every watt put into the loud speaker five must be supplied as HT current. The efficiency of the pentode is 30 per cent. to 35 per cent.; so although it costs more it may be worth it in the long run, so far as mere cash is concerned. This comparison

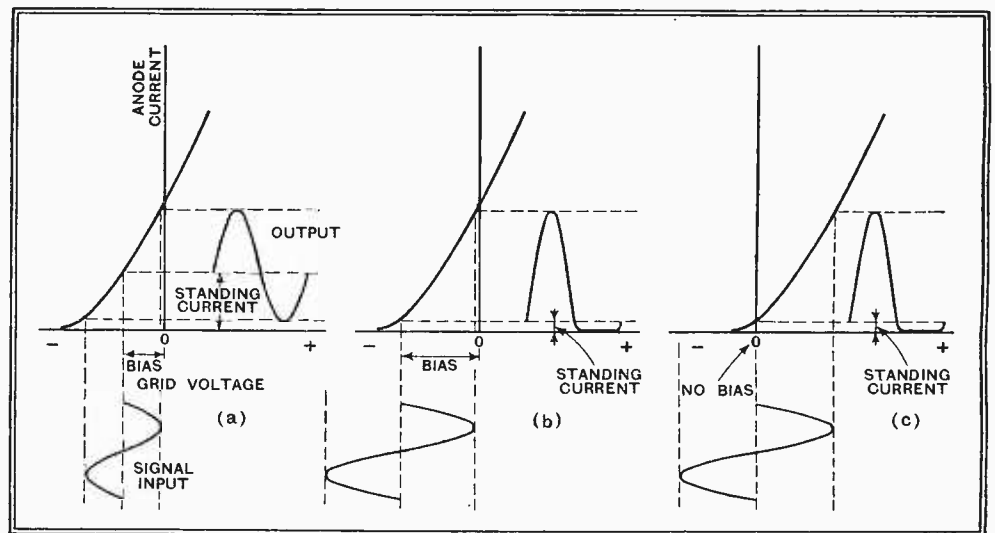

The three diagrams provide a quick comparison between (a) Class "A," or normal operation; (b) QPP; (c) Positive-drive Class "B." Points to note are the economical standing current of (b) and (c) compared with (a); the double normal bias in (b) and zero bias in (c); the slight distortion of (a) and enormous distortion of (b) and (c), all of which can be practically eliminated by using a balanced pair of valves; and the positive grid voltages of (c).

current drawn bears some relation to the work done; piecework, in fact, rather than time-work. If the grid bias of a single output valve is increased until the anode current is practically nil in the absence of a signal, it is reduced to 1915 conditions, and one half of every signal wave is entirely suppressed, causing fearful distortion. But by using two valves, connected as in push-pull, both half waves continue to be amplified in these circumstances. When there is no signal the anode current is quite small—it cannot be reduced to nil without distortion, owing to the curved foot of the characteristic—but when a signal is applied the anode current

applies to any sort of output stage, not QPP only. But whatever the efficiency of the valve, used singly or in push-pull with normal bias, it is at least half as much again with QPP (or Class "B"). The reason can hardly be explained non-mathematically, so I am not going to do it here; but I want to emphasise that this second economy of QPP is absolutely in addition to the first, and would be gained even if the output stage were working all-out all the time, when the first would show no advantage.

The combined effect of these two economies is to put the battery set on more nearly level terms with the mains

* "About Push-Pull."

About Push-Push—

driven. The obvious thing to think of is to do the same for the mains-driven set, to make it still cheaper to run. But the saving in the ordinary receiver is so small as not to be worth certain drawbacks of the system (which I will describe in a moment), and in any case it is more difficult to design a mains power unit to supply a fluctuating current. In public address work, or amplifiers to modulate transmitters, where the power bill is a serious matter, it may pay to take some trouble over the design in order to economise. A sort of compromise, called Class "AB," has recently become popular, in which the bias is adjusted to an intermediate value, giving Class "A" operation for small volume (but with correspondingly small current drain) and something like Class "B" for large.

I have hinted that although the change from one class to another can be effected merely by suitably increasing the grid bias voltage, this involves rather more than at first sight appears. There are the advantages already described. There is also in QPP the necessity for increasing the input signal voltage. The grid bias is usually about double and so must be the signal voltage to work each valve fully. Remember that instead of both valves working all the time they alternately work and rest, so when they are working they must work doubly hard to keep up the output. Therefore, a QPP intervalve transformer is generally designed to give an exceptionally high step-up ratio. This means either some falling off in goodness or an increase in cost.

Hum Cancellation

Then one advantage of push-pull, that the signal current is kept out of the HT supply, so that much decoupling of the previous stages is unnecessary, is sacrificed. Hum cancellation (if mains drive is used) is also sacrificed, except during intervals or very quiet periods; but as that is about the only time hum is noticeable, even when present, this disadvantage is not very serious. In fact, the smallness of the HT current during the quiet periods makes it particularly easy to smooth. The real disadvantage is that unless conditions are just right, particularly as regards the valves being perfectly matched, there is a decided tendency towards an unpleasant sort of distortion.



With reasonable care, which means adjusting the screen voltages of the valves (if pentodes) and using decent components, the QPP system can be very satisfactory. The other sort of Class "B" requires much more care in the design of each part of the system, as well as adjustment, to avoid a fuzziness or rattle in the reproduction; and at the best it is never quite as good as the best QPP. The essential difference is that whereas QPP follows normal amplifier practice in keeping the signal voltage entirely on the negative side, so as to prevent the flow of grid current, Class "B" proper employs no grid bias, or very little; and the positive half waves of the signal consequently draw grid current. This means that at such moments the valve, from grid to filament, is no longer an almost infinitely high resistance, but quite a low one of only a few thousand ohms. With ordinary amplifiers this would cause the intervalve transformer to be so heavily loaded that the positive half cycles would be distorted almost to vanishing point. So several modifications have to be made: (a) the transformer must have a step-down ratio; (b) the previous valve must be of the smaller power type; (c) the output transformer ratio must be calculated rather differently from usual. In fact, compared with Class "A," the whole design is frightfully involved to calculate properly, and it must be done properly to be even tolerably successful. For these reasons it has largely lost its original popularity, and comparatively few sets now on the market include it. The maximum power obtainable is higher than with QPP, there is no grid-bias system to provide and the cost of a double valve is considerably lower, but to offset this an extra stage of amplification is generally needed. And, on the whole, reproduction is inferior.

A good deal of criticism is levelled against both systems on the ground that the momentary high peaks of current, amounting perhaps to 40 mA., are a great strain on the battery. So perhaps they are if the set is kept blaring away on full power all the time. But it must be remembered that cells no bigger than those in HT batteries are used to supply 300 mA. in small torches for more than momentary periods.

Finally, let me remind you that in America (and therefore, generally, here) "Class 'B'" now covers all half-wave amplifying systems, so the full name of the second system is strictly "positive-drive Class 'B.'"

"WIRED WIRELESS" INTER-COMMUNICATION SYSTEM.—A combined transmitter-receiver introduced by a New York firm as a substitute for—or supplement to—the ordinary type of telephone. Connection to the mains (AC or DC), which provide operating power and act as a guide for modulated RF current, is made through a single plug. The speaker is of the moving-coil type and four valves are employed in the instrument, which is intended for use in offices, factories, etc., as well as in the home.

**MCCARTHY****Introducing****an exceptional new receiver for the all-wave enthusiast!**

For all-wave reception at its very best, exceptional range and power and large output, together with a number of interesting new features, few receivers will be found to equal the new

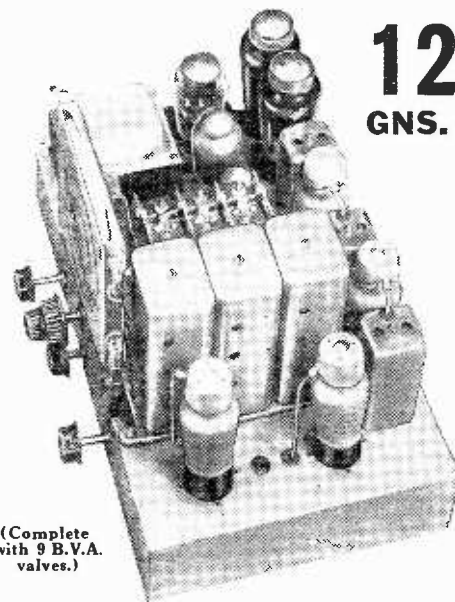
MCCARTHY 9-VALVE ALL-WAVE SUPERHET**12
GNS.**

(Complete with 9 B.V.A. valves.)

4 wavebands: 12.8-33, 29-80, 190-550, 800-2000 metres. Illuminated dial with principal station names. Separate coloured lights for each waveband.

Controls.—A feature of the receiver is the number of independent controls fitted, making it extremely interesting to operate. These include: sensitivity control (varying bias on R/F stage). Q.A.V.C. with manual muting control, and switch for inter-station noise suppression. Separate potentiometer bias controls for output valves. 5-position wave-change and gramophone switch. Progressive variable tone control operative on radio and gram.

Circuit in Brief.—Aerial input to pre-selector circuit, radio frequency amplifier, latest type triode-hexode frequency changer, 2 band-pass I.F.T. coupled I.F. amplifiers, double diode detector. L.F. amplifier, parafeed transformer-coupled push-pull triode output giving 6 watts.

Heavy cadmium-plated steel chassis. Finest components and workmanship throughout.

Due to an unprecedented demand for this receiver, there may be a temporary short delay in delivery. Owing to its many special features, production cannot be unduly speeded up; but all orders are being fulfilled in strict rotation, and ample supplies to meet all requirements will shortly be available.

IMPORTANT

The prices at which McCarthy Chassis are advertised include Marconi Royalties. "Wireless World" readers should, for their own protection, make sure before purchasing any receiver that the quoted price includes the Royalty payment.

All McCarthy receivers supplied complete with valves, knobs, pilot lamps, leads, mains cable and plug. 12 months' guarantee.

Deferred terms on application, or through London Radio Supply Co., 11, Oat Lane, E.C.2.

Cash with order on 7 days' approval. Also write for illustrated catalogue of complete range of all McCarthy receivers.

MCCARTHY RADIO LTD.
44a, Westbourne Grove, London, W.2

Telephone: Bayswater 3201/2.

RANDOM RADIATIONS

Who Invented the Telephone ?

MOST people if asked that question would reply without hesitation that it was Alexander Graham Bell. But at Frankfort there is a monument, erected over the grave of Philipp Reis in 1878, which describes him as the inventor of the telephone. Bell's invention was made in 1875, but in 1860 Reis had produced an electrical apparatus, which he named the telephone. Was Reis's device really a telephone? And if so was it the foundation of Bell's invention? The subject is full of interest, and it is dealt with in a most entertaining leading article by Professor G. W. O. Howe in the April issue of *The Wireless Engineer*. Professor Howe's conclusions are that Reis did in fact invent an electric telephone by which certain sounds of the human voice could be transmitted and received, but there is no satisfactory evidence that it succeeded in making speech intelligible. He was certainly not the inventor of the true telephone, though his transmitter may possibly have inspired the development of the microphone.

Queer Instruments

Reis's transmitter contained a diaphragm of sausage-skin or something similar with a small piece of platinum attached to its centre. This made contact with another piece of platinum attached to a spring. Sound waves striking the diaphragm and setting up vibrations thus caused a make-and-break, but *not* a varying resistance, as in Bell's microphone. The receiver, which utilised a principle known and described as early as 1837, consisted of a steel knitting needle, surrounded by a solenoid carrying the received current, and supported at its ends by little pillars attached to a sounding board. At each "make" the needle is magnetised and increases its length. The "break" causes it to return to its original length with a slight click. If a note is sung into the receiver the clicks correspond in frequency and a sound of the same pitch is reproduced. To some extent inflexions of the speaking voice would be recognisable, and from these occasional simple words might be guessed; but intelligible speech did not become possible, and the telephone was not really invented till Bell conceived the idea of applying the principle of continuously variable resistance.

Not Guilty

TWO readers hailing respectively from Basingstoke and Cambridge have taken rather violent exception to the paragraph in which I suggested a week or two ago that "a capable and well-trained man might make a good living in many districts by setting up as a curer of radio troubles. . . . Once he had established a bit of a reputation for good work and fair charges he should be able to make wireless servicing a whole-time occupation." For some reason both seem to think that I am encouraging the dabbler, the fellow who learns as he earns. Well, the heading of the paragraph was "Experts Wanted," and since I specified that the would-be service man should be capable and well trained, I think I can plead not guilty on that score. It's just the half-baked service-man, who is wont to take on jobs that are quite beyond him, that I was hitting at. And nobody can build up a reputation for

By "DIALLIST"

good work if he doesn't know his job and do it conscientiously.

Television Aerial Problem

A NEAR neighbour of mine has just installed a television set and is getting first-rate reception from the Alexandra Palace even on a temporary and not very high aerial. According to the B.B.C.'s field strength map his house is quite close to the 0.5 millivolt-per-metre contour line for an aerial of roof height. His present one certainly isn't that. In fact, to get a high enough aerial is going to be his big difficulty. Passing cars and lorries, of which there are many, cause a good deal of interference, and it's going to be a bit of a problem to raise that aerial above the zone of the interference that comes from their ignition systems. For certain reasons it can't be erected above the roof, and the house stands on so steep a slope that the garden behind is a good ten feet below the level of the roadway in front. The only solution seems to be to put up a mast about 45 feet high in the garden. But even so a complication may be introduced by a couple of tall lime trees which may exercise a blanketing effect when they are in full summer foliage. In one of the graphs drawn by B.B.C. engineers from measurements taken in a stationary van on Balham Hill the field strength shows variations of more than four to one from moment to moment. These variations are stated to be entirely due to reflection and absorption effects of passing traffic. If passing cars can do that intermittently, what about the permanent effects of big trees?

A Case of Leakage

THE other day I was preparing a brand new 6-volt car starting battery for use as an aid to certain experiments. The three cells of the battery are not connected in series, though they are arranged in the usual way to enable this to be done by short straps when required. That is, negative of cell A is next door to positive of cell B and negative of cell B to positive of cell C. I was checking up the EMF of each cell with a 500-ohm-per-volt volt meter when I happened quite by chance to put the prods on to adjacent positive and negative terminals belonging to two different cells. To my surprise the meter registered a PD of 0.9 volt. Other pairs of terminals were then tried, and in every case the volt meter had something to say, the readings ranging from about a quarter of a volt upwards. This of course showed that the cell-to-cell insulation was pretty poor, a thing one would hardly expect in a new battery with a perfectly clean and dry moulded case. You can't wonder if a battery like that runs down when it is standing idle!

Television Test Transmissions

THOSE whose business it is to install television receivers will welcome the news that the B.B.C. is thinking of sending out test transmissions each week-day between 11 o'clock and noon. As things are, if you don't manage to get the aerial up and the set in by 3 p.m. there's nothing available

inside ordinary working hours until the following afternoon. It is proposed that the transmission shall be just a cross on the vision wavelength and a tuning note on that belonging to sound. Any reason why whatever the London Regional or National is doing shouldn't go out on the sound wavelength instead of the tuning note? If that could be arranged as a stop-gap until the whole of the Regional programme is broadcast on the ultra-short waves it would enable owners of television sets to get a little more use out of their apparatus. Some that I have met feel that two hours a day is a somewhat meagre ration.

A Wanted Switch

And that brings me to another point. In view of the fact that we are likely to have eventually a high-fidelity transmission of the London Regional programmes on a wavelength in the neighbourhood of seven metres, every television receiver ought surely to be fitted with a switching arrangement enabling the vision part of the receiver to be thrown out of action and the "sound" part to be used independently. With some receivers this can be done; with others it can't. The switching shouldn't be difficult to arrange, and its presence may be a biggish selling point in the not-so-distant future.

A Heart Cry

"**M**Y life's ambition," writes a service man reader, "is to retire to Dartmoor, my native heath, and to have enough money saved to buy one cheap and nasty commercial receiver a day and kick it down over Yes Tor." My sympathy and best wishes!

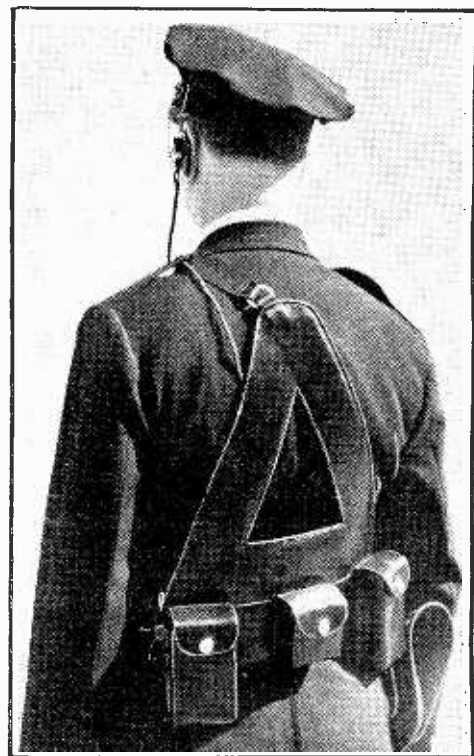

POLICE RADIO IN U.S.A. So far as his radio burden is concerned, the lot of the American patrolman seems to be less happy than that of his confrere the British policeman. Though it lacks a calling device, the American receiver shown here is considerably more bulky (and conspicuous) than the set used by the Brighton Police. Note the triangular frame aerial; the two outside wallets contain HT and LT batteries while the single-valve receiver is in the centre.

DISTANT RECEPTION NOTES

MAY I thank the Henley reader and others who have been kind enough to send me information about Radio Nacional and Radio Verdad? I determined to try to get to the bottom of the matter, and to that end tuned in Milan on 368.6 metres at 10.45 p.m. on Sunday, April 11th. At 10.55 the station's own programme came to a close, and nothing was heard for five minutes. At 11 o'clock Radio Verdad announced itself, the speaker stating that the daily transmission in Catalan was about to begin. This continued until about 11.20.

One thing I can say definitely: whatever else it may be, Radio Verdad is not the same as Radio Nacional. Just before 11.15 I turned to 270 metres and heard the latter announced. Flicking rapidly from 270 to 368.6 metres, I found that two quite different transmissions were in progress. A speaker with a rather high-pitched voice was delivering a harangue to Viscaya from Radio Nacional: Radio Verdad's deep-voiced announcer was giving out news.

At about 11.20 Radio Verdad's Catalan transmission ended, and after a brief interval it was announced in ordinary Spanish that a transmission in that language was about to start, and that it took place every day (I could not quite catch the hour, but I think it was at 11 p.m.) simultaneously on 304, 368, 420 and 491 metres. Round figures were given with no decimals. I tried the other three wavelengths, finding nothing in the neighbourhood of 304 or 420 metres. The 368.6-metre transmission, however, was being given simultaneously on 491.8 metres.

Well, that is what I heard. I offer the facts without further comment. Those who want to check them will find Sunday night a good time; the medium-wave band is pretty clear by 11 p.m. or a little earlier as so many stations have then closed down.

The Future of Long Waves

Some time ago I suggested tentatively in these notes that it might be a good thing if long-wave broadcasting ceased to be, since so many long-wave stations occupy not only their own channels with their fundamental transmissions, but also a good many others with their harmonics. And then there's the "Luxembourg Effect." I don't feel at all sure, after spending some time recently in exploring it, that broadcasting on this band will not die a natural death. In the daytime (atmospherics permitting) reception is reasonably good from Radio Paris, Hilversum, Kalundborg, Luxembourg, and Droitwich.

But after dark the long-wave band is just a mess. Radio-Paris and Droitwich are then the only stations that are usable as a rule, if one demands any sort of quality. Heterodynes, jamming and sideband-splash ruin the rest, and I don't know that Droitwich will be able very easily to avoid interference from the new Deutschlandsender when it gets to work. The long-wave band might just have pulled through if the provisions of the Lucerne Plan had been carried out to the letter. But they haven't been by any manner of means.

Every country seemed to have regarded this band as a kind of radio Eldorado. There was a regular gold rush, and so many claims have been staked that they overlap one another. Unfortunately, there is no international authority powerful enough to

play the part of the two-gun tough sheriff of the mining camp!

Here are a couple of forthcoming cleared channel broadcasts by small-powered stations in the U.S.A. that may lure dyed-in-the-wool D-xers who thirst for fresh conquests. Every Friday the 1-kilowatt WORK (York, Philadelphia) transmits on 1,320 kc/s or 227.1 metres between 1.45 and 2 a.m. On Sunday KGER (Long Beach, California), also 1 kilowatt, transmits on 1,360 kc/s, or 220.4 metres, from 6.30 a.m. till 6.45. Stations of higher power in other parts of America that give special broadcasts are: CFRB, Toronto, Canada, 10 kilowatts, 690 kc/s, or 4,345 metres, Saturdays 5-5.5 a.m.; TGW, Guatemala City, Guatemala, 10 kilowatts, 1,210 kc/s, or 247.8 metres, Sundays 5 a.m. onwards; PRE3, Rio de Janeiro, 10 kilowatts, 1,220 kc/s, or 245.8 metres, Sundays 5-8 a.m. D. EXER.

Television Programmes

Transmission times are from 3-4 and 9-10 daily.

Vision: 45 Mc/s. Sound: 41.5 Mc/s.

FRIDAY, APRIL 23rd.

3, Rawicz and Landauer: two pianos. 3.10, Friends from the Zoo. 3.25, Gaumont-British News. 3.35, "A Midsummer Night's Dream": mask arranged from the fairy scenes of Shakespeare's play.

9, Victor Hotchkiss and his marionettes. 9.10, Repetition of 3.10 programme. 9.25, British Movietonews. 9.35, Repetition of 3.35 programme.

SATURDAY, APRIL 24th.

3, For the Children: Zenora the Clown. 3.10, Demonstration of horse-riding by Major Faudel-Phillips. 3.25, British Movietonews. 3.35, Variety.

9, Starlight: Lina Menova in songs. 9.10, Bridge: Hubert Phillips, President of the London and Home Counties Contract Bridge Association, will, with three others, play a game of bridge and give explanations. 9.25, Gaumont-British News. 9.35, Play Parade.

MONDAY, APRIL 26th.

3, "The Proposal": a jest in one act by Tchekov. 3.20, British Movietonews. 3.30, The Vagabond King.

9, Light Musical Act. 9.10, Coffee Stall: a light entertainment. 9.30, Gaumont-British News. 9.40, Cabaret Revue

TUESDAY, APRIL 27th.

3, Music Makers: Eugene Pini (violin). 3.10, The World of Women. 3.25, Gaumont-British News. 3.35, Cabaret Parade: scenes from the Grosvenor House "Midnight Variety."

9, Carnations: exhibits from the British Carnation Societies Show. 9.10, Repetition of 3.10 programme. 9.25, British Movietonews. 9.35, Cabaret Parade.

WEDNESDAY, APRIL 28th.

3, Coffee Stall: a light entertainment. 3.20, British Movietonews. 3.30, Forty-ninth Picture Page.

9, A Little Show. 9.20, Gaumont-British News. 9.30, Fiftieth Picture Page.

THURSDAY, APRIL 29th.

3, The Composer at the piano: Marc Anthony. 3.10, Masks through the Ages—III. 3.25, Gaumont-British News. 3.35, The Mizzen Cross-Trees: a revue of nautical songs through the ages.

9, Josef Marais and his "Camp-fire on the Karoo" trio. 9.10, Repetition of 3.10 programme. 9.25, British Movietonews. 9.35, "The Young Visitors," from the book by Daisy Ashford.

"WHEN we find
T.C.C. condensers we
look for the trouble
SOMEWHERE ELSE

A SERVICE ENGINEER

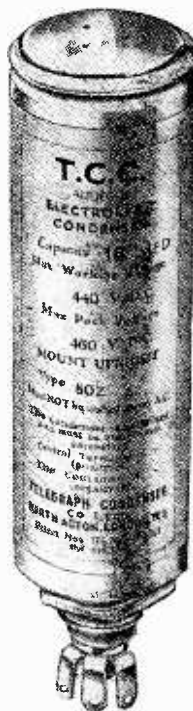

So said a service engineer to us recently. The mere fact that T.C.C. Condensers are in a Receiver, tells him straight away that at least a dozen possible breakdown points can be eliminated.

The most prolific cause of breakdown in a modern A.C. Receiver is the momentary building-up of HIGH-SURGE VOLTS at the instant of switching-on. It may result in a complete set of "blown" valves, burnt out resistances or transformer windings, and other 'mysterious' faults. Eliminate the cause itself... at source, by fitting T.C.C. 'Wets.' With these perfect safety valves in circuit high surges cannot develop, voltages are kept below peak working. Not only are the T.C.C. Condensers themselves SURGE-PROOF, but their very presence makes all associated components secure against damage. Play for safety... use T.C.C. 'Wets.'

FOUR STANDARD TYPES

- 802. 16 mfd. 440v. Continuous Peak wkg.
- 602. 8 mfd. 440v. Continuous Peak wkg.
- 805. 8 mfd. 500v. Continuous Peak wkg.
- 809. 32 mfd. 320v. Continuous Peak wkg.

— that STOP
HIGH SURGE
VOLT DAMAGE

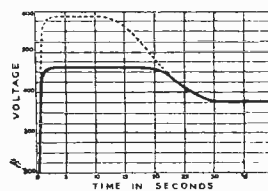

T.C.C.

ALL-BRITISH
CONDENSERS

The Telegraph Condenser Co. Ltd., Wales Farm Road,
N. Acton, W.3.

CA 1635

New Apparatus Reviewed

RECENT PRODUCTS OF THE MANUFACTURERS

RIDCO CHASSIS AND CABINETS

THE latest addition to the range of radio products made by Radio Industries Development Co., Birch Street, Hanley, Stoke-on-Trent, is a series of semi-metal cabinets and an aluminium chassis.

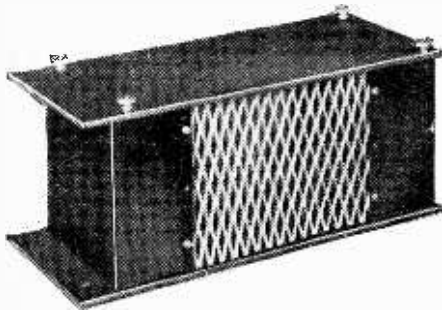

Semi-screened cabinet Type R/C2 made by Ridco.

The cabinets will be useful in the construction of oscillators, amplifiers and similar pieces of apparatus. They provide partial screening only, since the top and bottom are closed with panels of insulating material on which the components can be assembled. The sides only are made of metal. The two models sent in for examination are the R/C1 and the R/C2; the former measures 6in. by 5in. by 5in. and costs 4s. 6d., and the size of the latter is 12in. by 6in. by 6in. and its price is 8s. 6d. In the larger model two of the sides are fitted with expanded metal to provide ventilation as well as screening. They are finished in black enamel.

The Ridco standard chassis is made of No. 20 gauge aluminium and measures 12½in. by 8½in. by 3in. deep, and it is finished in

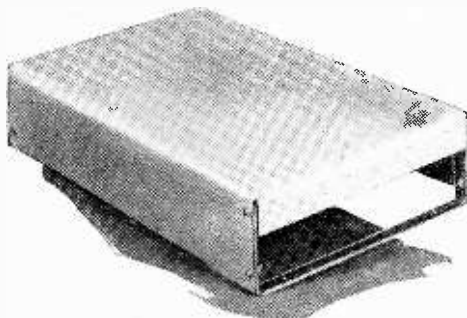

Ridco cellulose-finished aluminium chassis.

grey cellulose. It costs 6s. 6d. The chassis can be supplied drilled to specification and for this a charge of 2s. 6d. is made.

H.M.V. ALL-WAVE AERIAL

THE H.M.V. all-wave aerial is designed for use on all wavelengths from 7 to 2,000 metres, and it is of the type that discriminates between radio signals and man-made static.

Actually it comprises three aerials 60ft., 39ft., and 5ft. long respectively, all three

being joined to a special aerial transformer from where a screened downlead is taken to another transformer unit that should be screwed to the receiver close to the aerial and earth terminals.

The receiver transformer unit is fitted with a three-position switch marked 7-30, 30-200, and 200-2,000 metres respectively, and this switch has to be set to the appropriate position according to the waveband on which reception is required. Though the best way to erect the aerial is with the two long lengths of wire horizontal and in line, other arrangements are permissible when space is restricted, and these are all described very fully in the instructional booklet.

To be effective as a noise-reducing system, the horizontal part must be located outside the interference zone, which means it must be as high as possible and well away from buildings.

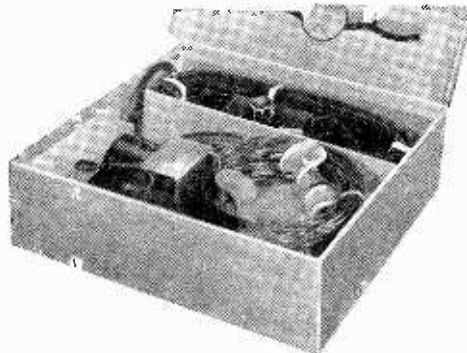

H.M.V. all-wave anti-static aerial, Type No. 213.

Tests made with one of these aerials show that it compares very favourably in efficiency with an ordinary aerial of equivalent length and height; there is no noticeable reduction in signal strength due to the anti-interference properties, and a better signal-to-noise ratio is definitely obtained when the aforementioned precautions are taken. Good reception on all bands down to the television sound wavelength was obtained during the tests.

The aerial is made by the Gramophone Co., Ltd., 98-108, Clerkenwell Road, London, E.C.1, and the price complete with wire, insulators, and assembled ready for erection is 37s. 6d.

B.T.S. COIL UNIT FOR SW CONVERTER

BRITISH Television Supplies, Ltd., Faraday House, 8-10, Charing Cross Road, London, W.C.2, has sent in for examination a complete coil unit for the AC Short-wave Converter described in last week's issue of *The Wireless World*.

The unit is made exactly to the specification so far as the construction, winding, and mounting of the coils and other components are concerned, and the only difference is that the box is made of steel instead of aluminium. All the joints in the box are spot

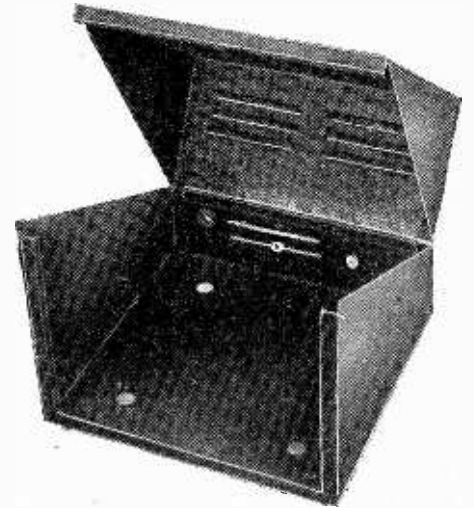

B.T.S. steel cabinet for "W.W." AC Short-Wave Converter.

welded, and it is finished inside and out in grey cellulose.

Since the metal of the box is sprayed, the makers have, with our approval, provided an earthing terminal on the top of the signal circuit compartment, and this should be joined to the moving-vanes terminal on the condenser C4.

The coil unit is exceptionally well made and satisfactory in all respects for use in the converter. The price is 30s.

B.T.S. have at the same time submitted a metal cabinet of the correct size for housing the converter. It is made of steel and finished in black crackle enamel. Two small holes only need to be drilled in the front panel of the converter to secure it.

Ventilation holes and louvres have been

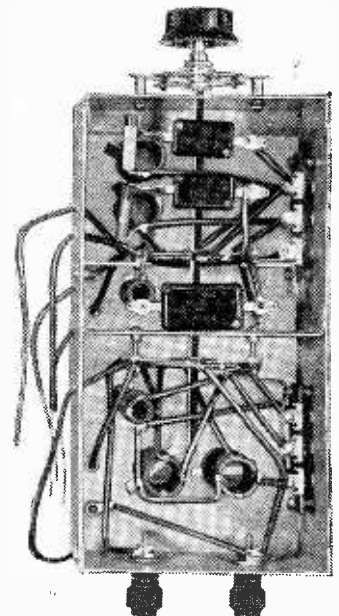

Coil unit made by B.T.S. for "W.W." AC Short-Wave Converter.

provided in the correct places and as suggested in the article, so that this cabinet makes an ideal housing for the converter.

The price of the cabinet is 18s. 6d.

Letters to the Editor

The Editor does not hold himself responsible for the opinions of his correspondents

Flutter

I WAS very interested to read the letter submitted by Mr. G. H. Bradbury in your April 2nd issue. He appears to be under a misapprehension regarding my previous letter *re* "AVC Flutter" (February 26th).

He states that the effect as he has observed it occurs above 9 Mc/s, and appears to be due to frequency-changer "wander." As, however, the particular receiver on which I experimented was a straight six-stage (or should I say five-valve?) model of my own design, which operated solely on a range of 200-2,000 metres (1,500-150 kc/s), it seems that the type of flutter he is referring to is of a different character to that which I described.

I think, therefore, that my explanation of the effect is vindicated as "wander" is scarcely likely to occur on these wavelengths, least of all with a straight receiver.

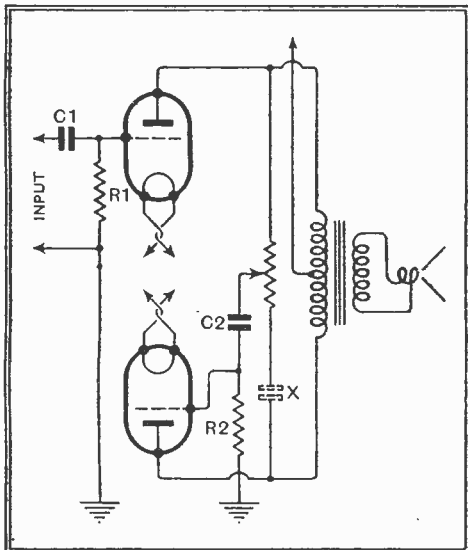

Balancing a Push-pull output stage.

To this statement I should like to add that superhets behave in much the same way, but that I used a straight receiver in my observations, as it happened to be the type I was using for my normal listening at the time.

Incidentally, my original statement that "Push-pull AF . . . is, perhaps, the best method of all," should have the proviso added that *true* push-pull should be used, and not a system which is out of balance at 5 c/s. I say this because I find some people favour the system shown in the diagram, which cannot be balanced at 5 c/s and 400 c/s simultaneously unless a condenser is inserted at "X" of such value as to counteract the loss due to C2 R2.

Wimbledon, S.W.19. R. G. YOUNG.

Recording

AS I have no immediate interest in recording and no money to waste on patents I send the following which may be useful to others, and which I have not seen advocated so far, though it may be used under some fancy title, of course.

Cellophane, the wrapping material of boxes of chocolates, etc. (usually thought to be gelatine by the uninformed), is regenerated cellulose and is produced by the action of caustic soda in the cold and carbon disulphide (method of Cross & Bevan), i.e., Viscose.

It is easily cut and can be obtained fairly thick from makers such as the Cellophane Co. in London.

It possesses a curious property of reacting direct with acetic anhydride without the necessity for any catalyst and forms the exceedingly hard and horny cellulose acetate.

If, therefore, a disc of thick cellophane sheet be mounted with a suitable adhesive (not water soluble) on a disc and cut, treatment with acetic anhydride will produce a record of considerable durability.

Acetic anhydride is not materially more nasty than some of the substances already used for hardening, though it also reacts with fingers, clothes, etc., and would probably be best applied with a rubber sponge stuck in the end of a test-tube.

WM. A. RICHARDSON.

Ashford, Kent.

Coronation "Street Parties"

I HAVE been asked to fix up PA apparatus for two "Street Parties" during the Coronation celebrations, but have been compelled to refuse because of the prohibitive cost of separate licences for gramophone record reproduction.

As these "Street Parties" are for poor people, I would have to do the job almost "free, gratis and for nothing," and suggest that the gramophone licensing authorities might similarly do their part by granting licences at a nominal fee for an occasion that is only likely to arise twice in a lifetime.

London, E.C.2.

J. E. H.

Set Prices in India

I RECENTLY came across a peculiar fact relating to prices of radio sets in India.

A six-valve model with C.R. tuning indicator, by a well-known English maker, costs 16 guineas in England and 300 rupees in India. A four-valve set of the same make is priced at 13½ guineas in England and 295 rupees in India.

These Indian prices are equivalent to £22 10s. and £22 2s. 6d. respectively, so the difference in prices of the two sets, fixed by the maker at 2½ guineas, is only 7s. 6d. in this country.

One fails to see why the four-valve is almost as dear as the larger model.

Perhaps some reader may be able to suggest a reason. Can it be that the six-valve receiver is being sold cheaply? I doubt it.

Peshawar, N. HANSFORD.
N.W.F.P., India.

POINTS OF IMPORTANCE in the Rola G.12



YOU KNOW A GOOD CIGAR BY THE BAND

A good name on a cigar band is all the proof a connoisseur needs of the excellence of the product. Similarly, to the radio connoisseur, a Rola G.12 in a wireless set is an absolute guarantee of that receiver's high quality. He *knows* that no manufacturer would fit such a speaker in an indifferent set . . . he *knows* that the G.12 is the most faithful reproducer made to-day . . . he *knows* that, if he is a manufacturer, it will pay him to install G.12's in his "class" receivers and if a listener it is sound policy to see that his radio set is G.12 equipped.

G.12 D.C. (as illustrated) Stripped and without Transformer	£3 15 0
G.12 D.C. Complete with Transformer, Mounting Stand, Handle and Base	£5 5 0
G.12 D.C. with Mounting Stand, Handle and Base, but without Transformer	£4 18 0
G.12 D.C. Stripped, but with Transformer	£4 4 0
<small>(When ordering please state Field Resistance and Impedance of Transformer required.)</small>	
G.12 P.M. less Transformer	£4 18 0
G.12 P.M. with Transformer	£5 5 0
<small>For Public Address work both the P.M. and Energised Models can be supplied with a 15 ohm Voice Coil at an additional charge of 3/-.</small>	

Write for Folder A.

OVER 8 MILLION IN USE

ROLA

The World's Finest Reproducers

THE BRITISH ROLA CO. LTD.
MINERVA ROAD, PARK ROYAL, N.W.10.
PHONE WILLESDEN 4322-3-4-5-6.

Recent Inventions

Brief Specifications of the more interesting radio devices and improvements issued as patents will be included in this section

SOUND AND PICTURE RECEIVERS

WHEN tuning a combined sound and picture receiver from one alternative programme to another, the usual inter-station "noise," as experienced on an ordinary broadcast receiver, is likely to be greatly aggravated, since the picture signals will also affect the loud speaker. In addition, the sound-modulated carrier waves are liable to produce "flashes" of light on the screen of the cathode-ray tube. These effects are not only disagreeable, but may result in actual damage to the apparatus, particularly to the cathode-ray tube.

According to the inventions, steps are taken to keep the whole receiver inoperative, until both the sound carrier and the picture carrier of the desired station are present at the same time. The required control may be exercised by making use of the beat frequency between the desired sound and picture carrier waves, when both are present, to remove a "muting" bias, which normally paralyses one or more of the amplifying valves of the set.

Marconi's Wireless Telegraph Co., Ltd. (assignees of R. S. Holmes). Convention date (U.S.A.) June 28th, 1934. No. 458798.

MODULATING SYSTEMS

THE figure shows a chain of cathode-coupled amplifiers V, V1, V2 supplying a push-pull

modulator stage A, B, which is fed with carrier oscillations from a source O. The object of the invention is to prevent distortion due to grid-current.

The grid of the second amplifier V1 is given a slightly positive bias from the source GB, and the resulting grid current which flows through resistances R, R1 is opposed by the output current from the anode of the first amplifier V. The current through the resistance R reduces the negative grid bias on the amplifier V and so increases its output current. This action is assisted by the potential drop across R1, which increases the effective anode voltage applied to the amplifier V from its H.T. source.

In the same way the tendency for the grids of the push-pull modulator A, B to accumulate a negative charge, and so cause distortion, is counterbalanced by the effect of the resistance R2 on the grid-bias and anode voltage of the amplifier V2. The grid-biasing voltages are derived from a floating battery G.B.

Baird Television, Ltd.; G. W. White; A. J. Brown; and P. W. Willans. Application date May 27th, 1935. No. 458861 (Drg.).

SCANNING SYSTEMS

SCANNING is effected in groups or strips of parallel lines, the inclination of one group of lines being varied with respect to the next group, so as to give a "criss-cross" effect. As applied to a cathode-ray tube, the desired result is obtained by periodically changing the connections between the saw-toothed oscillators and the deflecting-plates inside the tube.

For instance, at one moment the horizontal pair of deflector plates is connected to the output from one saw-toothed oscillator, whilst at the next moment the same

oscillator is connected to the vertical pair of deflecting plates. The change-over can conveniently be effected by a commutator switch

each of the abutting edges of the mirrors. The ends of the pins are notched to prevent the wire from slipping off.

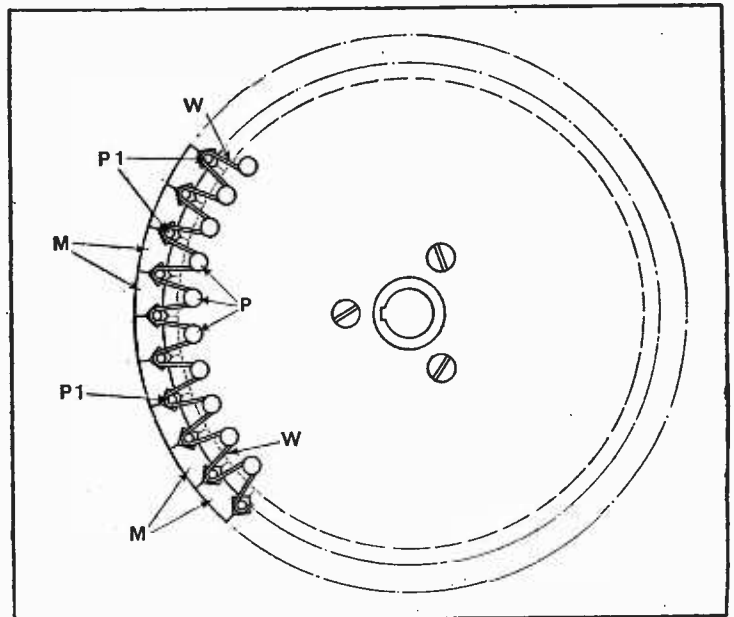

Method of securing mirrors on scanning drum in television apparatus.

inserted in the leads from the time-base circuits to the deflecting-electrodes.

J. L. Baird and Baird Television, Ltd. Application date July 4th, 1935. No. 459177.

MIRROR DRUMS FOR TELEVISION

THE small mirrors M of a television scanning-drum are anchored firmly in position by a wire W, which is threaded as shown between pins P fastened on each side of the disc, and pins P1 laid in V-shaped grooves cut in

The arrangement prevents any tendency for the mirrors to be displaced by centrifugal force when the disc is rotated at high speed.

Ferranti, Ltd., and M. K. Taylor. Application date September 26th, 1935. No. 458618 (Drg.).

RADIO-NAVIGATION SYSTEMS

IN the ordinary overlapping-beam method of marking-out a navigational course through the air, the aviator steers his way by comparing the strength of the received signals. The two beams are usually modulated with "complementary" Morse signals, such as the letters A and N, which merge together into a continuous note, so long as the aviator keeps to the correct course, along the centre line of overlap. Should he stray to one side or other, the received note breaks up, and either the letter A or the letter N predominates, thereby indicating a deviation to port or starboard.

According to the invention, the true course is determined by a comparison of the time-interval between the two signals instead of by a comparison of their relative strengths. A sharply-defined radio beam is swung to and fro at constant frequency over a small angle on each side of the course to be flown. So long as the pilot keeps to the centre line the modulating notes recur at equal intervals, but if he deviates to one side or other the intervals become unequal. If the beam is modulated with different notes on each side of the centre line, the variation in sequence, as well as duration, will indicate whether the deviation is to port or starboard.

Telefunken Ges fur drahtlose Telegraphie M.B.H. Convention date (Germany) May 27th, 1935. No. 458347.

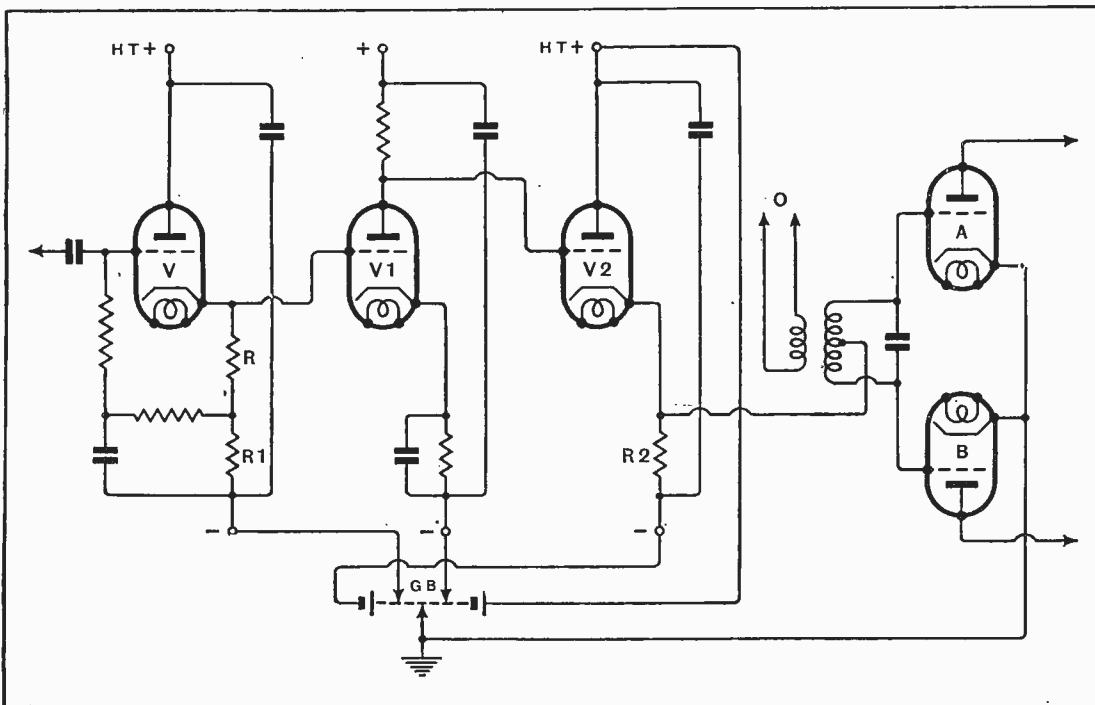

Modulation amplifier designed to prevent distortion due to grid current.

NEW PROJECTOR TYPE Public Address LOUDSPEAKER

Incorporating a new design of horizontal plane directional baffle with special Duplex Horn, this new Loudspeaker provides the effect previously only obtainable with two speakers.

Sound distribution is vastly improved—particularly of the high notes. Moreover, the special diaphragm fitted gives extremely good high note response.

Especially noteworthy is the fact that the highly efficient Permanent Magnet Unit is totally enclosed in a non-resonant chamber thereby considerably increasing the loading on the diaphragm at low frequencies, and obviating risk of damage to the diaphragm in the event of overload.

GOODMANS

for Quality Reproduction

GOODMANS INDUSTRIES LTD., Lancelot Rd., Wembley, Middx.

Telephones: Wembley 4001-3.

GOODMANS Duplex
Horn P.A. Loudspeaker



Speech Coil impedance
15 ohms.
Power handling capacity
12 watts peak A.C.
Horn: length 2' 10".
Width: 2' 11".

Price **£4:10s.**

SPECIAL HIRE TERMS FOR CORONATION

DEMONSTRATIONS of this and other GOODMANS Loudspeakers held every Thursday Evening at the Wembley Works between 6 p.m. and 7 p.m. (5 mins. from Wembley L.M.S. and Bakerloo St., and Buses). Other demonstrations by appointment.

COUPON

Post to-day in unsealed envelope (½d. stamp) to:—
GOODMANS INDUSTRIES LTD., Lancelot Road, Wembley, Middx.
for fuller details of the Duplex Horn type P.A. Loudspeaker.

If you desire Technical Bulletin and Response Curves for High Fidelity Auditorium Loudspeakers, enclose 3d. stamps.

Name

Address

W.W. 23/4/37.

B.I. HIGH VOLTAGE CONDENSERS

for
RADIO and TELEVISION



We can offer a complete range of High Voltage Condensers in all capacities and for all working conditions met with in Radio and Television Sets.

In accordance with our standard practice these are impregnated with a special Petroleum Jelly.

The insulated terminals have ample creeping surface, and we recommend these condensers with the utmost confidence.

BRITISH INSULATED CABLES LTD.

Cablemakers and Electrical Engineers

PRESCOT—Lancs.

Telephone No.: PRESCOT 6571

London Office: Surrey House, Embankment, W.C.2

Tel. No.: Temple Bar 7722

DICTIONARY of WIRELESS TECHNICAL TERMS

Compiled by S. O. Pearson, B.Sc., A.M.I.E.E., and Issued in conjunction with "THE WIRELESS WORLD"

SECOND EDITION

Revised and brought up to date

THIS handy volume is very much more than a Dictionary. It not only takes the technical terms of wireless and explains their meaning, but in doing so it concentrates into a small space a large amount of information on wireless subjects. It has become, in fact, a compendium of wireless knowledge, and an invaluable handbook for all who are interested in wireless transmission and reception. Diagrams and illustrations are freely interspersed throughout the book to amplify the explanations of the text.

272 pp., bound in cloth boards
Size 5 by 3 inches

Price 2/- net By post 2/2

From all leading booksellers or direct from the Publishers

ILIFFE & SONS LTD.

Dorset House, Stamford Street, London, S.E.1

W.W.48

Mention of "The Wireless World," when writing to advertisers, will ensure prompt attention.

MISCELLANEOUS ADVERTISEMENTS

NOTICES

THE CHARGE FOR ADVERTISEMENTS in these columns is

12 words or less, 3/- and 3d. for every additional word.

Each paragraph is charged separately and name and address must be counted.

The proprietors retain the right to refuse or withdraw advertisements at their discretion.

Postal Orders and Cheques sent in payment for advertisements should be made payable to **ILIFFE & SONS, Ltd., and crossed & Co.** Notes being untraceable if lost in transit should not be sent as remittances.

NEW RECEIVERS AND AMPLIFIERS

A.

A.

DEGALLIER'S, Ltd., the firm for reliable short wave radio, have on show in London the largest selection of fully guaranteed brand new all-wave receivers; callers invited to handle all these at their leisure without obligation to purchase; all S.W. receivers will get stations on the low bands, including the Americas, etc. Closed all day Mondays. All goods cash with order or c.o.d. Handsomely illustrated catalogues forwarded on receipt of large stamped addressed envelope or stamp 24d. Our models receive American transmissions at full programme strength; demonstrations daily after 4.30.

6/6 Each.—Valves for American receivers, all guaranteed, each a first, no seconds or throw-outs; for every known set from 1927-37; metal, metal glass, glass counterparts, and glass; in ordering just state type and number, we have it, all post paid; line cords for all midgets, 4/6 each.

£3/10—T.R.F. Midget receiver. "The smallest of its type in the world," medium and long wavebands, moving coil speaker, 2 watts output, no earth required, compact and transportable, leather cloth covered, obtainable in various colours; carriage 1/-.

£7/7—Table model six-valve all-wave superhet, tuning 16½-50, 200-250, 800-2,000 metres, high efficiency resistance-capacitance circuit with A.V.C., station calibrated dial, 8in. moving coil speaker, cabinet of handsome appearance and super acoustic, 17×13×9½, operates on A.C. or D.C. mains, 200-250 volts; never before such tone from a D.C. receiver, carriage 4/6.

13 Gns.—The new Challenger 8 (type 800) table model De Luxe, 22×18×12, high fidelity 8-valve superhet, A.C. 200-250 volts, waveband coverage 11-32, 27-65, 190-550, 900-2,000 metres, simplified centralised tuning, super slow motion vernier slow-last tuning dial calibrated in metres, with station names, self contained control panel, perfect tone quality at low volume, new type, M.C. 10in. speaker, from a whisper to 8 watts pure undistorted tone, no overloading at full volume, oscillator fundamental without use of harmonics, persistent oscillator of highest output, isolating filters eliminate oscillation and motor boating, fully delayed A.V.C., P.D. terminals (switching and volume control incorporated in the front panel), absolute minimum of noise, sensitivity control for noise suppression. Reinforced capacitors prevent drift, pre-aged intermediate frequency transformers, I.F. barrier discs, anchor coil leads, plug-in loudspeaker, moisture sealed out by tropical zone impregnation, self healing electrolytic condensers. One complete chassis of dreadnought construction, moderate voltages assure full valve life, economical to operate, 75 watts consumption, correct valve selection, no compromise, no hum, full weight transformers, true push-pull, stabilised H.T. supply, stabilised biases, ceramic coil insulation, fully loaded plate coils give maximum gain, pre-balanced coil assembly, sealed insulation, thin laminations of special silico steel, 7 k.c. selectivity, fractional microvolt sensitivity, shielded switching permits high gain, positive silver plated contacts eliminates switch noises, audio frequency range 30-8,000 cycles, diode detection, Prizmatone high fidelity, R.F. selector stages on all bands; carriage 5/6.

£12/18—"800" chassis valves and 10in. speaker with all escutcheons, etc.; carriage 4/-.

£14/18—"800" chassis valves and G.12 12in. Rola high fidelity speaker; carriage 6/-.

£17/17—Challenger "800C" Console, height 3ft. 6in., width 24in., depth 12½in.; this is the 800 chassis with G.12 Rola; carriage and crate 10/-.

NOTE—The Challenger 800 is available in 11-valve A.C./D.C. 200-250 volts, at an additional cost of 20/- on each model.

29 Gns.—Challenger "800RG" radiogram, with automatic changer "Garrard"; this job also incorporates the G.12 high fidelity Rola, carriage and crate 15/- A.C./D.C. model £2 extra.

14 Gns.—Challenger 381 8-valve 14-2,060 metres, Polychromatic dial scale, improved vision master, beam power output, band spread Magna dial and second-hand magic eye tuning, automatic band indicator, high image frequency suppression, hair line selectivity, 5 k.c. separation; carriage 5/6; less cabinet, £13/18; carriage 4/-.

THE Following Bargains Cannot be Repeated, owing to the fact that they are samples; these are also covered by the usual guarantee in Great Britain against faulty workmanship and materials; owing to the weight and difficulty in packing, these are available to callers only, and a visit to our showrooms will be well worth while.

(This advertisement continued in third column.)



THEY SHALL HAVE "MUSIC"

It is being made the subject of some lamentation that up and down the country and throughout the world a real appreciation of music is steadily being killed: that the human ear, grown more and more attuned to faulty reproduction, has come to accept the less familiar sounds of actual performance as unreal.

There is indeed enough truth in the exaggeration to warrant the plaint; and it is the sad fact that in a world rich in glorious music and gifted executants (not to overlook that plenitude of broadcasting men and women whose spoken words are of the very stuff of melody)—it is the sad fact that the generality of radio listeners are content with mere sounds made reasonably intelligible.

Radio has much to answer for, but this side of the millennium and until real values become the everyday demand of the millions, the less particular listener will endure the awful "good enough." Which is just too bad.

Meanwhile, finer sensibilities are well taken care of, as you know, and in this wise:

M.A. receiver, with power pack and all valves, 7-watt	£32 10 0
Do. do. 12-watt	£35 0 0
S.A. receiver, complete with valves, 7-watt	£25 0 0
Do. do. 12-watt	£27 10 0
Duode-de-luxe speaker, 20-watt, D.C. model	£6 10 0
Rectifier for A.C. feed	£1 5 0
Transformer to suit your valves (any standard type)	£1 0 0

As recently announced, the above prices are increased by 10% owing to greatly increased cost of materials.

COME AND HEAR THEM



HARTLEY TURNER RADIO LTD.,

THORNBURY ROAD,
ISLEWORTH, MIDDLESEX.

Telephone: HOUUnslow 4488

ADVERTISEMENTS for these columns are accepted up to FIRST POST ON MONDAY MORNING (previous to date of issue) at the Head Offices of "The Wireless World," Dorset House, Stamford Street, London, S.E.1, or on SATURDAY MORNING at the Branch Offices, 19, Hertford Street, Coventry; Guildhall Buildings, Navigation Street, Birmingham, 2; 280, Deansgate, Manchester, 3; 26a, Renfield Street, Glasgow, C.2.

The proprietors are not responsible for clerical or printers' errors, although every care is taken to avoid mistakes.

For particulars of Box Number Advertisements and Deposit System see previous issues.

NEW RECEIVERS AND AMPLIFIERS

(This advertisement continued from first column.)

£37/10—Six only 1937 24-valve Garod receivers, twin chassis and 2 Public Address speakers, 5 wavebands covering 5-2,000 metres, 60 watts undistorted output; this chassis is also available in Console form at £7 extra, this cabinet alone cost to make over £15.

£35—Three only 24-valve Lafayette twin chassis and 2 speakers, 5 wavebands, 8-2,000 metres, 30 watts undistorted; also 1 Console at £41/10, and 1 radiogram with record changer at £50.

DEGALLIER'S, Ltd., 18, Connaught St., Marble Arch, London, W.2. Paddington 2745. [4223]

A.

AIR KING.

ALL Models Feature Beam Tuning, Magic Eye Indicator, gramo. pick-up connections, and special output valves.

ALL Sets Fully Guaranteed; H.P. terms available from 3/- per week.

WHOLESALE and Trade Enquiries Invited; generous terms.

ALL Types of American Valves Stocked; write for lists to

AIR KING RADIO, 115, Shaftesbury Av., Cambridge Circus, W.C.2. Phone: Temple Bar 4875 (2 lines). All receivers assembled in England. [3406]

A.

N.

GLO AMERICAN RADIO, Ltd., introduce the following magnificent range of Crosley chassis for the Coronation.

CROSLEY'S Reputation and Unsurpassed Standard of Workmanship is Your Guarantee of Satisfaction.

CROSLEY Superheterodynes to Suit Every Need, from the unsurpassed 10-valve all-wave 5-band to the 6-valve short and medium wave 3-band; our Coronation cash prices save you 40-50% now.

£12/19/6—10-valve High Fidelity 5-band (13-31, 30-80, 75-200, 200-555, 750-2,000 metres), A.C. 97-240 volts, 10 watts undistorted output, metal valves, pre-H.F. stage on all bands, provision gramo. and doublet, push-pull output, super A.V.C., band-spread pointer, metre calibration of airplane dial; side by side tests prove that this receiver outperforms multi-valve sets with double the number of valves; you cannot buy a better set; the all-world reception is a revelation; the tonal quality from a whisper to the full 10 watts is magnificent; to-day's value £25, your price £12/19/6; with 12in. American Magnavox speaker, £15.

£11/19/6—9-valve, 5-band, A.C. 10 watts, as above but employing glass valves; with Magnavox speaker, £14

£9/19/6—8-valve, 5-band, A.C. as above, but with modified output stage only, giving 4 watts undistorted; with 12in Magnavox speaker, £12

£8/19/6—8-valve, A.C. 3-band, 2 models (1) 17.5-500, 200-555, 750-2,000 metres, 4 watts undistorted output, provision gramo. and doublet, pre-H.F. on all bands; with matched Magnavox speaker, £9/15.

£6/19/6—6-valve, A.C., 3-band, 2 models, as above, 4 watts output, A.V.C., no pre-H.F. stage, gramo., doublet; large 7in. colour airplane dial.

ORDER with Confidence—These Crosley radios bring nothing but unbounded satisfaction on all sides; whichever model you choose you know you simply cannot buy a better job in its class at double or treble the price.

4D. Stamps Post Free—Advance applications now being received for our wonder new radio catalogue; covers every radio need; receivers, communication sets, accessories, short-wave gear, etc., in colours and illustrated.

ANGLO AMERICAN RADIO (AND MOTORS), Ltd. (Dept. W.14), Albion House, New Oxford St., London, W.C.1. (Showrooms, 39, New Oxford St.) Telephone: Temple Bar 3251, 9821. [4302]

ALERT RADIO Co.

COMMUNICATION RECEIVERS, all-wave chassis, complete receivers of all types, American valves, spares and service; we also have a few reconditioned receivers.—21, East Rd., N.1. Clerkenwell 4871. [3787]

NEW RECEIVERS AND AMPLIFIERS

ROYAL RADIO Co.
ALL-WAVE Receivers, suitable for use on ships, as supplied to officers of many shipping lines.
OUR 8 and 10 Metal Valve All-wave Receivers; 15-2,000 metres, acknowledged by the trade as the best for range, tone, and general performance.
LAATEST 6-valve Car Radio, A.V.C., remote control, no suppressors required.
A FULL Range of the World Famous Ferguson and Pilot Models Stocked.
ALL Sets Fully Guaranteed by Ourselves.
ALL Types of American Valves Stocked.
PAY Us a Visit Any Time, or send for full range catalogue; 1/4d. stamp will be appreciated.
ROYAL RADIO Co., 5, Buckingham Rd., South Woodford, London, E.18. Phone: Buckhurst 2736. [4111]
"SERVICE With a Smile."

HENRY FORD RADIO, Ltd.
ELECTRONIC House, 22, Howland St., Tottenham Court Rd., W.1. Museum 5675. [0511]
HARMAUR RADIO for Wireless Receivers from £3/3; Raytheon glass and metal valves and all components; trade enquiries.
THE HARMAUR RADIO Co., Ltd., 8, Clifford St., New Bond St., London, W.1. [0499]
PILOT, Ferguson, Sparton, American transportable, car radio, and others; traders; lists.—Perseus Co., W.W., Burton-on-Trent. [4264]

£7/5.—Six-valve all-wave chassis with 8in. Rola, B.V.A. valves, royalties paid, twelve months' guarantee.—Coulphone, Hutton, Preston. [4229]

MCCARTHY New Series of A.C. Universal, battery, all-wave and other receivers, many refinements, several interesting new models.
IMPORTANT!—All prices quoted for McCarthy chassis include Marconi royalty payments.
MCCARTHY All-wave Battery Superhet, with R.F. stage, £7; separate triode oscillator, L.F. stage, pentode output, ext. speaker and gram. sockets, etc.; equals mains performance.
MCCARTHY 6-valve All-wave Superhet, with R.F. stage, £8/5; A.C. or universal, iron-cored I.F. coils, Litz-wound tuning coils, illuminated "Airplane" dial, triode-hexode frequency changer, double band-pass coupled I.F. amplifier, L.F. stage, pentode output, D.A.V.C. tone control, ext. speaker and gram. sockets, etc.; etc.; performance equals many 8-valve receivers.
MCCARTHY Special 7-valve All-waver, with R.F. stage, four wavebands, many interesting new features; £10/10; full particulars on application.
MCCARTHY Super 9-valve All-waver, with push-pull triode output; £12/12; a set for the connoisseur! —For full particulars see McCarthy advertisement, page 407.

ALL McCarthy Receivers on Heavy Cadmium-plated A Steel Chassis; quality components and B.V.A. valves throughout.
MANY Other McCarthy Models.—Write for complete catalogue.
MCCARTHY RADIO, Ltd., 44a, Westbourne Grove, London, W.2. [4225]

PERLESS Chassis De Luxe Model, 1938, 11 valves, 12 1/2in. speaker, 4 wavebands, 18 watts output, specially made for short-wave reception; come up and test it; £14/14.—Kay, 47, High St., Camden Town, N.W.1. [4221]

TRANS-ATLANTIC RADIO For the Finest All-wave and Mains-compact Receivers, from 59/6; lowest prices American valves and components; prompt radio repairs.—Trans-Atlantic Radio Co., 15, Percy St., W.1. Museum 3096. [4235]

PILOT, Ferguson, Belmont, Pegasus, and Air King all-wavers lead the field; our deliveries are prompt in original cartons, with full guarantees; your trade card will bring our wholesale catalogue from the authorised distributors.—Leonard Heys, 36, Henry St., Blackpool. [0530]

COMMUNICATION Receivers, Hammarlund, National, Hallicrafters, R.M.E.69, Tobe-Deutschmann; transmitters, Collins 45A, Peerless DX20, or built to order; American valves, microphones, Eddystone components.—A.C.S., Ltd., 52-4, Widmore Rd., Bromley. Phone: Ravensbourne 0156 [0550]

RECEIVERS AND AMPLIFIERS

CLEARANCE, SURPLUS, ETC.
CLEARANCE List (Trade Only).—Write Leonard Heys, 36, Henry St., Blackpool. [0527]
1937 Portables, Burndept or Vidor, new, in sealed cartons, with batteries; £3/12/6.
ROLA G12, 1,000 ohms, with trans. P.P.; £2/12/6.—22, South End, Croydon. [4261]

ARMSTRONG Co. Have a Further Few Soiled but Genuine Brand New Radio Chassis for Disposal at Considerably Less Than Cost Price, described hereunder.
ARMSTRONG 1937 9-stage Radio-gramophone Chassis, covering 4 wavebands from 12.9 metres. circuit H.F. Pentode as radio frequency amplifier, tuned H.F. transformer coupled to hexode triode, detector oscillator, 2 band-pass coupled I.F. amplifier stages, double diode triode, detector and L.F. amplifier, push-pull output stage capable of handling 6 watts, highest grade components used throughout, "Airplane" multi ratio drive, all wavebands calibrated station names, tone control works on both radio and gramophone, provision for extension speaker, etc.
SEVERAL Chassis as Above, brand new, but chassis slightly marked; price, complete with Marconi and Mullard valves, 9 gns.; an exceptional opportunity.

ARMSTRONG 1936 Colonial 7-valve All-wave Chassis, two only; £6; complete with British valves.
ARMSTRONG 1936 Colonial 8-valve All-wave Push-pull Chassis; two only, £7, complete with British valves.
ARMSTRONG 7-stage Superhet Radiogram Chassis, 2 wavebands, complete with new 8in. Rola speaker; one only, 5 gns., complete with British valves.
ARMSTRONG Co. Will Willingly Send Above Chassis on 7 Days' Trial, carriage and packing free.
ARMSTRONG MANUFACTURING Co., 100, King's Rd., Camden Town, N.W.1. [4242]

No. 35.

Notes

on Flat Pin Plugs and Sockets to B.S.S. 666

This comparatively new specification issued by the British Standards Institution is devoted to plugs and sockets for radio speech circuits up to 50 watts (the specification also limits the steady current to 5 amps. R.M.S. and the steady speech volts to 80 volts R.M.S.):

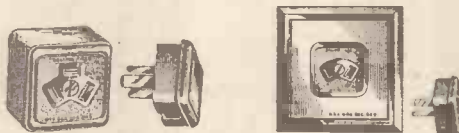

The contact pins of the plugs are flat instead of round, and the resilience is in the "socket" contacts, although strictly speaking they are not sockets. Such arrangements have been used for some years in Canada and the U.S.A., and in certain European countries, but this is their first official recognition in this country.

Their purpose is to render it impossible to plug headphones or loudspeakers into mains sockets. They are ideal for use for loudspeaker and phone extensions, particularly in hospitals and for radio relay installations, microphone circuits, etc. All types are non-reversible. They are available for flush or surface mounting, the flush mounting types being designed to fit into either standard metal or wooden conduit boxes.

Either two-pin or three-pin types with pins and "sockets" numbered are supplied, and in the interests of standardisation we may add that with the three-pin type, pin No. 3 is intended for centre tap or earth, or unsmoothed H.T. as the case may be, pin No. 2 then being common H.T. and speech.

They are carefully thought out as regards design. They have side entry for flex, and are the neatest plugs and sockets yet produced. They are moulded in brown bakelite as standard. Cream bakelite is available as a special at a higher price.

It is anticipated that a multitude of uses for this type will present themselves, but it is to be hoped that no one will be so thoughtless or stupid as to connect them to any mains circuit, even if they are more attractive in appearance than most used for this purpose.

2-pin Plug and Socket, surface or flush mounting.
No. 302. Brown Bakelite Complete 2/4
3-pin Plug and Socket, surface or flush mounting.
No. 303. Brown Bakelite 2/8
Cream Bakelite, either type Extra 10d.
FREE. Pocket size catalogue, "Radio Spares and Connections." Write for a copy.

Constructors and designers will appreciate our book "Radio and Electrical Accessories," containing 150 illustrations, including 75 blue prints of curves, diagrams, circuits and constructional details, and specification of all our standard products in the accessory class. Send 8d. for copy, post free.

BELLING-LEE
SUPPRESSION SERVICE

Belling & Lee Ltd.
Cambridge Arterial Road,
Enfield, Middx.
Telephone: Enfield 3322.

PUBLIC ADDRESS EQUIPMENT

SPECIAL Offer!!!

60 Watt Model for 6L6s, with microphone and gramophone independent inputs, and outputs for 4, 7 1/2, 15 and 30 ohm speakers, consumption 150 watts, in ventilated steel carrying case; £24 only! complete with valves less two 6L6s.

8 1/2 Gns. Complete.—Vortexion portable 15-20 watt 4-stage amplifier, independent mike and pick-up inputs, outputs for 7 1/2 and 15 ohm speakers, weight 25lb., 4 independent input model, £10.

HEAVY Duty 20 watt model, as fitted to dance halls and cinemas, etc.; £15, complete with valves.

WHY Not Call and Have a Demonstration.

VORTEXION, Ltd., 182, The Broadway, Wimbledon, S.W.19. Phone: Lib. 2814. [4254]

TRADERS, write for our lists; all best makes equipment supplied.—Perseus Co., W.W., Burton-on-Trent. [4266]

PARTRIDGE P.A. Manual, free to trade. See "Partridge Transformer" under "New Mains Equipment." [3487]

HARMONY HOUSE SOUND SERVICE, Southport.—Beam power amplifiers, 14 watts output; £13/10 (subject); send for lists. [0546]

EASCO 1937 P.A. Super Mobile Van available for engagements Coronation week, with operator driver.—Reliance 1893. Easco, 18, Brixton Rd., S.W.9. [0544]

TANNOY 30 amp. P.A. Equipment, undistorted output, for £20; also new Davenset charger for £5/10; offers considered.—Box 1608, c/o The Wireless World. [4287]

12-WATT Quality Amplifier and Speaker, 5 B.V.A. valves, Ferranti transformers, etc., amplifier £7/10. speaker 45/-. Piezo pick-up, new, 22/6.—41, Ashness Gardens, Sudbury, Middlesex. [4282]

Amplified Speech and Music for Fetes, sports meetings, etc., using our public address mobile equipments, also smaller equipments for dinners, dances, conferences, etc.—Harmony House Sound Service, Southport. [0548]

E.D.C. Converter, 24v. D.C. to 230v. 50v. A.C., 600w. filter, cabinet, £12; 55w. output, beam power amplifier, complete, new, £25.—Tate, Church St., Romsey, Hants. [4268]

G.E.C. 25-watt Amplifier, in steel-lined cabinet, complete with valves; two G.E.C. Auditorium speakers, mounted on large baffle, and converter unit for field supply for speakers, listed £85 approx., in perfect condition; £17/10.

HENRY'S, 72, Wellington Ave., London, N.15. Stamford Hill 2907. [4303]

TRANSVERSE Microphones, banquet and floor stands, 5-watt amplifier, 15-watt rack amplifier, valves, RK and Wharfedale senior speakers; will separate; wanted, Q.A. receiver, feeder, amplifier, Hartley duode De Luxe; s.a.c.—11, Wellington Rd., Bezley, Kent. [4288]

ARMSTRONG Latest Coronation 30-watt Public Address Amplifier, incorporating 3 input circuits and self contained Fader system. Both microphone stages have a total gain of 97db. and are electron coupled. This apparatus is particularly suitable where large output is required.

TECHNICAL Details: 3-stage L.F. amplifier having 3 inputs, both microphone stages use L.F. triodes, which are electron coupled, the input impedance of both stages remaining constant; first input stage coupled to L.F. triode, which incorporates gramophone input circuit; the output stage is push-pull class A.B. with self bias, transformer coupled to proceeding stage; power is obtained from a unit using 2 full wave rectifiers. The whole equipment constructed on 2 heavy pressed steel chassis; the finest British materials are used throughout; price, complete with 7 British valves, 16 gns. for 200-250 A.C. mains.

ARMSTRONGS, 100, King's Rd., Camden Town, N.W.1. Phone: Gulliver 3105. [4243]

USED SETS FOR SALE AND WANTED

DYNATRON

1937 Dynatron 9-valve All-wave Vulcan Console, superlative performance, cost £37; £25, or nearest, special reason for sale.—Box 1568, c/o The Wireless World. [4259]

LUXOR

12-VALVE Luxor, 10 wavebands, 15-2,100 metres, marvellous bandwidth, Q.A.V.C.; £17/10.—Gascoids, 84, Arthur Rd., Southampton. [4280]

MIDWEST

MIDWEST 18v. Chassis and Speaker, new June, 1936, with spares; £18.—Looker, 166, St. Anne's Rd. E., St. Anne's-on-Sea. [4279]

MISCELLANEOUS

1937 Sound Sales 2HF Radio Feeder Unit, unused, cost £10/7/6, P.I. moving coil microphone, perfect, offers wanted.—10, Juliet, Ashington, Northumberland. [4262]

5-VALVE A.C. Radiogram, Colpak tuner, Ferranti 6-watt push-pull amplifier, power pack, Rola G12 speaker, Pezo pick-up, solid oak sideboard cabinet; £12.—Smith, 20a, Lower Stone St., Maidstone. [4275]

EXCHANGE OR WANTED

"HOLIDAY Portable" or "Portabout" Wanted, complete or otherwise.—Gunnyon, "Capri," Woodhall Spa, Lincs. [4281]

NEW MAINS EQUIPMENT

VORTEXION Quality Transformers.

VORTEXION Supply the B.B.C., G.P.O., L.P.T.B., I.C.I., Borough Councils, etc. Why not you? LL Fitted Screened Primaries, and tapped 200-250v. with centre tapped filaments, guaranteed one year. W.W. Q.A., 425-0-425v. 120-160 m.a., 4v. 5-10a., 4v. 2.5a., 4v. 1-2a., 4v. 1-2a., super shrouded model; 32/-.

500-0-500v. 150 m.a., 4v. 4a., 4v. 2.5a., 4v. 2a., 4v. 2a., 4v. 2a., super shrouded model, 2.5% regulation, 35/-; open type, 32/-; 400 or 450v. same price. **350**-0-350v. 120 m.a., 4v. 2-6a., 4v. 2-4a., 4v. 1a., 4v. 1a., super shrouded, 25/-; normal shrouded, 21/-; open type, 18/6.

350-0-350v. 75 m.a., 4v. 2-4a., 4v. 1-2a., shrouded, 18/-; open type, 16/-. **250**-0-250v. 60 m.a., 4v. 2-4a., 4v. 1-2a., shrouded, 15/-; open type, 12/6.

AUTO Transformers, 100-120 to 200-240v.; 80 watts 11/-, 120 watts 14/6, 200 watts 21/-, 500 watts 37/6.

CHOKES—30h. 60 m.a., 7/6; 7-13h. 120 m.a., 12/6; 30h. 150 m.a., 15/-.

OUTPUT Transformers—4-10 watt W.W. Q.A., 21/-; 20 watt super shrouded, 30/-.

VORTEXION, Ltd., 182, The Broadway, Wembleton, London, S.W.19. (Telephone: Liberty 2814.) [3951]

PARTRIDGE Transformers, as supplied to B.B.C., Marconi's, G.E.C., Mulhards, I.C.I., Tungfram, etc.

SPECIALS Despatched Within 48 Hours; all standard types from stock.

SPECIAL Quotations to Manufacturers for Lots of 6 Upwards, hand wound, individually tested, immediate delivery, rock bottom prices.

TELEVISION Transformers Insulated to 10,000v. A.C. Expert knowledge of transmitting requirements (mains and modulation).

HIGH Fidelity (20 to 15,000 Cycles) Intervalve and Output Transformers a Speciality.

PARTRIDGE P.A. Manual Free to Trade Only; contents includes constructional amplifiers, notes on microphone, pre-amplifiers, lines, mixing impedance matching speakers, etc.

PARTRIDGE, N. B.Sc., A.M.I.E.E., King's Buildings, Dean Stanley St., London, S.W.1. Phone: Vic. 5035 [3717]

TANTALUM for A.C. Chargers, H.T. and L.T.—Blackwell's Metallurgical Works, Ltd., Garston, Liverpool. [3984]

CABINETS

RADIOGRAM Cabinets, new designs, 30/- to £5/10; inspection invited or photos for selection sent on request.

TABLE Radio Cabinets, undrilled, 6/6 upwards.

SPEAKER Cabinets, 4/6 upwards.

MANUFACTURERS' Clearance.

ULTRA Radiogram Cabinets, undrilled, 33x23x14 or 33x20x15, 30/-.

BURGOYNE "Pury" Radiogram Cabinets (undrilled), 34x22x16½, 29/6.

K.B. De Luxe Walnut Cabinets, undrilled, chromium plated edges and speaker grille, 25in. wide, 14½in. high, 10½in. deep, 18/6; Console model, 42in. high, 21½in. wide, 11½in. deep, 39/6.

HALYCON Radiogram Cabinets (Reconditioned), 33x23x19, 35/-.

H. L. SMITH and Co., Ltd., 287-9, Edgware Rd., London, W.2. Tel.: Pad. 5891. [0485]

DYNAMOS, MOTORS, ETC.

ALL Types of Rotary Converters in Stock, new and second-hand.

WARD, 46, Farringdon St., London, E.C.4. Telephone: Holborn 9703. [0518]

BELT Driven B.T.H., M.G. set, 230-volt, A.C. input, 720-volt, 120 m.a., output, complete with metal cabinet; £5/10—Empire, Exeter. [4286]

CONVERTER, M.L., 200-50 D.C. to 230 A.C., 85 watts, silence filter cabinet; £5; exchange for receiver, accessories, test gear.—Langton, Battersea 6290. [4274]

RECORDING EQUIPMENT

TRACKERS—Two Permarec 12-inch models, complete, scarcely used, sacrifice at £2 each, or separately; also B.T.H. Piezoelectric pick-up, as new, £1.—Box 1605, *The Wireless World*. [4294]

SHORT-WAVE EQUIPMENT

AMERICAN Reception Guaranteed on Any Receiver with the Rido "Ranger" Short Wave Unit, price 37/6, complete or on easy terms; send for illustrated lists.—Radio Industries, Birch St., Hanley, Staffs. [4263]

NEW LOUD-SPEAKERS

BAKER'S Quality Surplus Speakers; see displayed advertisement on this page. [4305]

VAUXHALL—Best quality speakers; see other column.—Vauxhall Utilities, 163a, Strand. [4299]

LOUD-SPEAKERS

SECOND-HAND, CLEARANCE, SURPLUS, ETC.

ROLA Speakers, brand new, boxed.

8IN., 1,000 ohms, with matching transformer, 6/6, postage 6d., Lineacords 2/- (American).

POWER Transformer, 6.3v. 2½ amp., 5v. 3 amp., 350-0-350, 100 m.a., 8/6, postage 6d.

RADIOGRAPHIC, Ltd., 66, Osborne St., Glasgow, C.I. Bell. 848. [4297]

FERRANTI M.1 Loud Speaker, permanent magnet, bargain, as new; £3.—Lavender Cottage, Bramber, Sussex. [4272]

Get in touch with BAKER for REALISTIC REPRODUCTION

1 BAKER'S SUPER QUALITY TRIPLE SPEAKER:

BAKER'S TRIPLE CONE SPEAKERS, fitted with curved cones, were first introduced in 1935, and the most popular has been the Super Quality Triple model. This famous speaker on sheer merit alone is now accepted as the best of all reproducers of speech and music for domestic use. No other speaker has a specification which includes—

- (1) Variable Frequency Response Unit.
- (2) Variable Volume Control.
- (3) Remote Control Unit.
- (4) Super Quality Output Transformer.
- (5) Highly efficient Dual Electro Magnet.
- (6) Central "H.F." Unit.

These and many other interesting details are fully described in our latest leaflet, "Loud Speaker Tailoring," yours for the asking. Your Dealer will be glad to demonstrate the Baker Super Quality Triple Speaker. Prices: D.C. Model, £7 7s.; A.C. Model, £8 15s.

2 EXCHANGES:

We will allow you a good price for your old speaker in part exchange for a Baker Super Quality Triple Speaker. Hundreds of "Wireless World" readers have already made exchanges with every satisfaction. Write NOW for quotation.

3 CONVERSIONS:

The next best thing to a Baker Super Quality Triple Speaker is a Triple Cone Conversion Assembly. Whether your moving coil speaker has a permanent or electro-magnet and no matter what type or make you possess, you can considerably improve frequency response and quality of reproduction by having a Triple Cone Assembly fitted, which comprises main curved cone and dual bakelite and duralumin cones combined, mounted in a 12in. die-cast aluminium frame.

The price is 29/6 complete, including free fitting at our Works. There is a special Triple Cone Assembly for owners of Baker's Super Power Speaker. Price 25/-, including coil.

4 QUALITY RECEIVER:

Baker's are shortly putting on the market an entirely new Quality Receiver specially designed for use with Baker Speakers. Every music-lover should look out for a further announcement which will appear shortly in the "Wireless World."

5 BAKER'S QUALITY SURPLUS SPEAKERS:

Hitherto Baker's Surplus Speakers have been sold through Agents. Quality enthusiasts in search of a bargain can now obtain these speakers direct from our Works. The following speakers are all brand new 1935/1936 models, and are offered at considerably under half list prices. If you are requiring Quality Reproduction at low cost, order one of the following exceptional bargains now. You will be amazed at the value obtained.

THE AUDITORIUM MODELS are fitted with latest triple cone, comprising main curved cone and bakelite and duralumin cones combined, giving wide and even frequency response resulting in quality reproduction of both speech and music.

39/6 Only, usual price £5.—AUDITORIUM PERMANENT MAGNET SPEAKER, with Alni magnet and die cast frame, large 12in. triple cone giving wide frequency range, complete with large 25 ratio transformer suitable for all outputs, including push-pull and Class B., etc.

59/6 Only, usual price £6.—AUDITORIUM ELECTRO-MAGNET SPEAKER, 1,000, 1,250, 2,000 or 2,500 ohms field, exceptionally large magnet of high permeability steel giving enormous flux density, 2in. moving coil, large triple cone giving wide frequency range, complete with universal transformer, the ideal speaker for use with "Wireless World" and other quality amplifiers.

75/- Only, usual price £9.—As above, but for use on A.C. mains; complete with Westinghouse rectifier and full smoothing equipment.

24/- Only.—PERMANENT MAGNET SPEAKER. Alni magnet, die cast frame, 10in. cone. Universal transformer.

15/6 Only.—PERMANENT MAGNET SPEAKER. Alni magnet, 8in. cone, Universal transformer.

12/6 Only.—PERMANENT MAGNET SPEAKER as above, with 7in. cone.

2/9 Only.—BRAND NEW CABINETS, 12x10x8.

8/6 Only.—ELECTRO-MAGNET SPEAKERS, with 8in. cone, 6,500 ohms field, Universal transformer. All Baker Quality Surplus Speakers are sold for Cash or C.O.D.

BAKER**BAKER'S SELHURST RADIO LTD.**

The Pioneer Manufacturers of Moving Coil Speakers, 1925-1937

75-77, Sussex Road, SOUTH CROYDON

(Croydon 3441.)

LOUD SPEAKERS—SECOND HAND CLEARANCE, SURPLUS, ETC.

VAUXHALL—Magnavox mains energised, 2,500 or 6,500 field coil, 10in. cone, 17/6; 7in. cone, 12/6. **VAUXHALL**—Magnavox permanent magnets, universal, suitable for Class "B" power or pentode, 7in. cone, 16/6; 10in. cone, 22/-.

VAUXHALL—American Rolas, 2,500, 8in., 15/-; 9¼in. 19/6; permanent magnets, 8in. 19/6, 9¼in. 24/6.

VAUXHALL—Above, fully guaranteed, complete with humbucking coils; state power or pentode transformer; unused manufacturers' stock.

VAUXHALL—Immediate delivery, carriage paid; lists free; cash with order or c.o.d.—Vauxhall Utilities, 163a, Strand, W.C.2. Temple Bar 9338. [4300]

TELEVISION APPARATUS

TELEVISION; limited number Ediswan 10in. cathode ray tubes, used for demonstrations, excellent condition; £5 each.—Furzehill Laboratories, Boreham Wood. [4291]

VALVES

ANDERSON.

AMERICAN Valves, all makes, first grade only; 5/- each. **ANDERSON**, 35, Lansdowne Rd., Walthamstow, E.17, Walthamstow 0827. [3551]

CHAMPION American Valves (R.C.A. licensed), 69 various types stocked; write for list; special discount to trade dealers.

THE UNIVERSAL RADIO Co., 221, City Rd., London, E.C.1. [4026]

RADIOGRAPHIC is the Right Place for all American Valves.

3/- Each Any Popular Type. Don't waste time asking us, send P.O., or c.o.d.; 3 months' guarantee.

RADIOGRAPHIC, Ltd., 66, Osborne St., Glasgow, C.1. [4298]

TRADERS, write for lists, cheap and best American and replacement mains and battery valves; lists.—Perusey Co., Burton-on-Trent. [4265]

AMERICAN Valves, first grade, in all types; trade supplied.—Metropolitan Radio Service Co., 1021, Finchley Rd., N.W.11. Speedwell 3000. [0436]

ALL Types of American Valves in Stock of Raytheon, Sylvania, and Arcturus makes, at competitive prices, guaranteed for six months; send for full list; 350 ohms line cords, 2/8.

WARD, 46, Farringdon St., London, E.C.4. Tel.: Holborn 9703. [0452]

NOTHING Better Available. Six months' guarantee, complete range of battery, A.C. mains, rectifiers, always in stock, 2 volt det., H.F., L.F., 2/3; Power, 2/9; screen grid pentode, H.F. pentode, 5/-; American types, six months' guarantee, 5/6 each, Nos. 18, 24A, 35, 42, 43, 45, 47, 56, 57, 58, 75, 77, 78, 80, 2A5, 2A6, 2A7, 6A7, 2B7, 6B7, 6C6, 6D6, 25Z5, 25Y5.—Write for other prices to Dulc Electrical Co., Devonshire Works, Duke's Av., Chiswick, London, W.4. [0501]

TESTING EQUIPMENT

WESTON Selective Analyser, complete in case with all adapters; £9, or offer.—Box 1607, *c/o The Wireless World*. [4296]

METERS, ETC.

FERRANTI 0.150 m.a. Flush-type Meter; list 35/-, two only, 16/6 each; Evershed and Vignoles Wee-Megger, 500-volt type, in red bakelite case, £6/5, in new condition.

HENRY'S, 72, Wellington Ave., London, N.15. Stamford Hill 2907. [4304]

NEW COMPONENTS

MICROPHONES—Reisz or Lapel parts.—A. Hinderlich, 2, Bridge Rd., London, N.W.10. [4006]

COMPONENTS

STANDARD-HAND, CLEARANCE, SURPLUS, ETC.

STANDARD RADIO SUPPLIES, 1, Dantzic St., Manchester. Note our very low prices.

RECEIVERS, Vidor band pass, 3 pentode all-wave battery set, moving coil speaker, wave bands 17-51, 185-550, 750-2,150 metres, list price 8 gns.; £3/3.

GRAMOPHONE Motors, genuine Garrard 202 A.C. 7 unit, comprising A.C. motor and pick-up, list 4 gns.; £2.

VALVES—Famous Europa A.C. types, HL, SG, VMSG, A.C. pen., 5-pin, H.F. pen., VMHF pen., FW rectifiers, 300v., all at 4/-; at 5/3 each, FC4 type, pen. 4VB type, FW350/120 m.a.; at 6/3, PM24M type; also full range of Hivac valves at full trade discounts.

AMERICAN Valves, No. 1 makes in most numbers, 5/-; good second quality tubes at 3/-.

COILS—Telsen iron core W349 (midnet size), 3/9; W478 (twin), 8/6; W477 (triple), 15/-; W476, 15/-; I.F. transformers, W482, 4/9; A.C. trickle charger, 2 volts at ½ amp., 11/6.

TELSEN A.C./D.C. Multimeter, 8/-; 3-range pocket meter, 4/-; 0.1 tubular condensers, 2/6 dozen; send stamp for quotations for any items you may require.

ALL Orders Value 5/- Post Free, under 5/- postage extra; no c.o.d. orders under 5/-.

STANDARD RADIO SUPPLIES—Every article sold is guaranteed.—1, Dantzic St., Manchester, 4. [4293]

ALL Goods Previously Advertised are Standard Lines, still available; post card for list free.

VAUXHALL UTILITIES, 163a, Strand, W.C.2. Over Denny's the Booksellers, Temple Bar 9338. [4301]

COMPONENTS—SECOND-HAND, CLEARANCE, SURPLUS, ETC.

RADIO CLEARANCE, 63, High Holborn, W.C.1. Holborn 4631. **FINAL** End of Season Clearance of High-Class Receivers and Components. **LISSEN A.C./D.C. Plus Rectifier Receiver,** fitted in a handsome walnut cabinet, clock face tuning, etc.; a really fine receiver; to clear £5/17/6. **LISSEN** Ditto, but all wave (3 wavebands covered, L short, medium and long); £4/19/6. **REGENTONE** All-wave 4-valve A.C. Receiver, fitted in a handsome walnut cabinet, circuit H.F. pentode, detector, pentode output, valve rectification, large type moving coil speaker; £4/12/6. **BUSH** A.C.23, 4-valve band pass receiver, fitted in handsome walnut cabinet, a really up-to-the-minute job; to clear at 4 gns. **THE** Following High-Class Surplus Stock are Offered. **POLAR** 3-gang Straight Condenser, fully screened, top trimmers, 3, 0.0005 section, a handy sized job; to clear, 4/11. **PLESSEY** Ditto; 4/3. **COSSOR** 2-gang, two 0.0005 sections, with separate vernier control, both main and vernier control operated from the panel; 5/6. **5-PIN** Chassis or Baseboard Mounting Valve Holders; a really first-class job; 3d. each. **7-PIN** Ditto; 7d. each. **PHILCO** Valve Screens, one-piece type with separate base; 4d. each. **ENQUIRIES,** 1½d. stamp if reply expected. **HOURS** of Business, 9 a.m. to 7 p.m., Saturdays 9 a.m. to 1 p.m. **ALL** orders 5/- or Over, post free. Orders under 5/- must be accompanied by a reasonable amount for postage. **C.O.D.** Orders Under 5/- Cannot be Accepted. **ORDERS** from Ireland and Special Parts of Scotland are Subject to Certain Increased Rates of Postage, and customers are advised to apply for details of postage before ordering. **RADIO** Clearance, 63, High Holborn, W.C.1. Holborn 4631. [4256]

PREMIER SUPPLY STORES. PLEASE See Our Displayed Advertisement on this page. [0488]

SOUTHERN RADIO'S Wireless Bargains; all goods guaranteed and sent post paid. **RECEIVERS**—Vidor 3-valve battery portable receivers, complete with 3 Osram valves, special Vidor long life batteries and accumulator, moving coil speaker, brand new, in sealed cartons; £3/17/6. **LUCILLE** 5-valve American Midget Sets, complete with 5 valves, moving coil speaker, ready for use on any mains, 100-250 volts A.C./D.C., long and medium waves; £3/15, new, in sealed cartons. **RECORD** Changers—Garrard Model R.C.4, plays automatically and changes eight 10in. or 12in. records of any kind, new, in sealed cartons; £6. **GRAMOPHONE** Motors.—Collaro electric radiogram units, for A.C. or D.C. mains, 100-250 volts, lully auto stop, complete with pick-ups, can be used on any mains, brand new, in sealed cartons, 57/-; Collaro spring gramophone motors, with 10in. turntable, complete with all accessories, 11/-; all Collaro motors are brand new, in sealed cartons. **SPEAKERS**—Celestion Soundex, permanent magnet, 10/-; Telsen permanent magnet, with 10-ratio transformer, to suit any receiver, 12/6; Telsen loud speaker units, 2/6; all brand new and boxed. **COILS**—Telsen iron core W.349 (Midget size), 4/-; type W.478 (twin), 9/- pair; type W.477 (triple), 16/- per set; type W.476 (triple superhet, selector and oscillator), 16/- per set; Telsen short wave coils, matched set of three, 4-pin bases, 12-26, 22-47, 41-84 metres, 5/- per set; Telsen dual range H.F. transformer and aerial coils, type W.154, 3/- each; all ganged coils complete on base with switch; Telsen I.F. transformer coils, 110 k.c., 5/-; Telsen dual range coils, with aerial series condenser incorporated, type W.76, 4/-; Telsen aerial condensers, with shorting switch, 2/-; all Telsen components brand new, in sealed cartons. **AMERICAN** Valves.—A full range of valves for all American receivers; 6/- each. **MISCELLANEOUS** Bargains.—All brand new, in original sealed cartons; Telsen A.C./D.C. multi-meters, test anything, radio or electrical, 8/6; Telsen 2-range voltmeters, 3/-; 3-range meters, including milliamps, 4/-; Ace (P.O.) microphones, with transformer, ready for use with any receiver, 4/6; Bell transformers, 200-250 volts input, 3, 5, or 8 volts output, 3/6; Morse signal units, incorporating buzzer, tapper and flash, with international code, complete with batteries and bulb, 3/9 each; lightweight headphones, double-pole, 4,000 ohms each earpiece, 3/- pair. **REGENTONE** Eliminators, A.C. 200-250 volts, type W.5a, with trickle charger; 37/6. **SOUTHERN RADIO**—Branches at 271-275, High Rd., Willesden Green, N.W.10; 46, Lisle St., London, W.C.2. All mail orders to 323, Euston Rd., London, N.W.1. **SOUTHERN RADIO**, 323, Euston Rd., London, N.W.1 (near Warren St. Tube). Phone: Euston 3775. [4192]

HEADPHONES, guaranteed, Brown, Ericsson, G.E.C., Sterling, Siemens, B.T.H., Nesper, etc., 2,000 ohms, 2/6; 4,000 ohms, 5/-; postage 6d. **SPECIAL** Ericsson, 4,000 ohms, as new, 7/6; Telenken, adjustable, lightweight, 2,000, 4,000 ohms; 7/6. **CRYSTAL** Sets.—Burne-Jones, complete, guaranteed, 5/6; ditto, double circuit, 8/-; sensitive permanent detectors, 1/6; crystal detectors, complete parts, 1/-; crystal with whisker 6d., postage 1½d.—Post Radio, 83, Caledonian Rd., London, N.1. [4171] **FERRANTI** A.F.S., 12/6; A.F.5(c), 16/-; 0-50 M.G. M.C. meters, 18/6; Parmeko chokes, 50H. at 60 m.a., 9/-; cash or c.o.d.—Grigg, 70, Peel Rd., Wealdstone, Middlesex. [4284]

PREMIER SUPPLY STORES

Offer the following Set Manufacturers' Brand New Surplus Goods at a Fraction of the Original Cost; all goods guaranteed perfect; carr. paid over 5/-; under 5/- postage 6d. extra. Orders under 5/- cannot be sent C.O.D.

ALL POST ORDERS TO JUBILEE WORKS, 167 LOWER CLAPTON RD., LONDON, E.5
CALLERS, AS USUAL, TO 165 & 165a, FLEET ST., E.C.4 (Next door to Anderton's Hotel). Central 2833. New Branch:—50, HIGH STREET, CLAPHAM, S.W.4 (Macaulay 2381).
Have you had our **GIANT ILLUSTRATED CATALOGUE AND VALVE LIST**? Send 4d. in STAMPS FOR THIS BARGAIN LIST.

MAINS Valves, famous Europa 4 v. A.C. types, 4/6 each. H.L., L., S.G., Var.-Mu-S.G., H.F.-Pens., Var.-Mu-H.F. Pens. 1- and 4-watt A.C. directly heated output Pentodes. A.C./D.C. types. 20-volt 18 amp. S.G., Var.-Mu-S.G., H.H.L., Power, Pen, H.F. Pen and V.-Mu-H.F. Pen. Following types all 5/6 each. Full-wave rectifiers, 350 v. 120 m.a. and 500 v. 120 m.a. 2½-watt indirectly-heated Pentodes, Octode Frequency Changers. **BATTERY** VALVES. 2 volts, H.F., L.F., 2/3. Power, Super-Power, 2/6. S.G., Var.-Mu-S.G., 4- or 5-pin Pentodes, H.F. Pens., V.-Mu-H.F. Pens. 5/- Class B, 5/-. **AMERICAN** Valves. Genuine American **HYTRON** and **TRIAD** first-grade Valves. 3 months' guarantee. All types in stock, 5/6 each. **210** and **185** each. New Metal-Glass Valves, all types, 6/6 each. Genuine American **DUOTRON** Valves, all types, 3/6 each. Valve holders for all above types, 6d. each. Octal bases, 9d. each. **SHORT-WAVE** COILS, 4- and 6-pin types. 13-26, 22-47, 41-84, 78-170 metres, 1/9 each, with circuit. Special set of 3-4-Pin S.W. Coils, 14-150 metres, 4/- set, with circuit. Premier 4-pin 3-band S.W. Coil, 11-25, 19-43, 38-86 metres. Suitable any type circuit, 2/6. **COIL** FORMERS, in finest plastic material, 1½in. low-loss ribbed, 4- or 6-pin, 1/- each. **SUPER CERAMIC** CONDENSERS, S.L.F., .00016, .0001, 2/9 each; double-spaced, .00005, .000025, .000015, 3/- each. All brass with integral slow motion, .00015 tuning, 3/9; .00015 reaction, 2/9. **CERAMIC** S.W. VALVE HOLDERS, 4-, 5- or 7-pin. Chassis types, 6d.; B.B. type, 8d. **GLASS** AERIAL INSULATORS, 4d. each. **BEEHIVE** STAND-OFF, 6d. each. **SCREENED** FLEX, single, 3d. yd.; twin, 4d. yd. **H.F. CHOKES**, S.W., 10-200 metres, 9d. **ELECTROLYTICS**. U.S.A., 4 or 8 mfd. 530 v. peak, 1/9 each. **Dubilier**, 4 or 8 mfd. 500 v., 3/-; 50 mfd. 50 v., 1/9; 10 mfd. 50 v., 6d.; 25 mfd. 25 v., 1/-; T.C.C. 8 mfd. 650 v., 4/-; 15 mfd. 50 or 100 v., 1/-; 50 mfd. 12 v., 1/-; Paper Condensers. W.E., 250 v. working 4 mf., 2/-; 2 mf. 150 v., 1 mf. 6d.; 350 v. working 4 mf., 2/6; 2 mf., 1/6. **Dubilier** 500 v. working 4 mf., 4/-; 800 v. 4 mf., 6/-; **COSMOCORD** PICK-UPS, with tonearm and volume control, 10/6 each. PICK-UP HEADS only, 4/6 each. **PREMIER** MAINS TRANSFORMERS, wire-end type with screened primaries, tapped 200-250 v. Centre-tapped Filaments. Guaranteed one year. H.T. 8 & 9 or H.T. 50 with 4 v. 4 a. C.T. and 4 v. 1 a. C.T., 8/6. 250-250 v. 60 m.a., or 300-300 v. 60 m.a., 4 v. 1 a., 4 v. 2 a., and 4 v. 4 a., all C.T., 8/6. 250-350 v. 120 m.a., 4 v. 1 a., 4 v. 2 a. and 4 v. 4 a., all C.T., 10/6. Any of these transformers with engraved panel and N.P. terminals, 1/6 extra. 500-500 v. 150 m.a., 4 v. 2-3 a., 4 v. 2-3 a., 4 v. 2-3 a., 4 v. 3-4 a., all C.T., 17/6. Super Model, 19/6. **AUTO TRANSFORMERS**, step up or down, 60 watts, 7/6; 100 watts, 10/-. **SMOOTHING** CHOKES, 25 m.a., 2/9; 40 m.a., 4/-; 60 m.a., 5/6; 150 m.a., 10/6. 2,500 ohms 60 m.a. Speaker Replacement Chokes, 5/6. **SPECIAL OFFER** OF PHILIPS MAINS TRANSFORMERS. 250-250 v. or 300-300 v. 80 m.a., 4 v. 5 a. C.T. & 4 v. 1 a., 6/11. **LARGER MODEL** WITH TAPPED PRIMARY, 100-250 v., 450-450 v. 150 m.a., 4 v. 4 a. C.T., 4 v. 4 a. and 4 v. 3 a. and 500-500 v. 100 m.a., 4 v. 4 a. C.T., 4 v. 4 a. and 4 v. 3 a., 12/6. **LIMITED** NUMBER ONLY. **MILLIAMMETERS**, moving-iron, flush 2½in., all ranges from 0-10 m.a., 5/9. Visual tuning, 6 or 12 m.a., 5/9. Moving-coil meters, 2½in. 0-1 m.a., 18/6; 3½in. 0-1 m.a., 22/6. Multipliers, 1/- each. **AMPMETERS**, 0-1, 3, 5, 10 or 20 a., 5/9. **TELSEN** Multi-meters, 30 and 300 m.a., 8, 16 and 240 v., 8/6 each. Reads A.C. and D.C. **TRANSFORMERS**, latest type Telsen R.G.4 (list 12/6), 2/9. Lissen Hypernik Q.P.P. (list 12/6), 3/6. **OUTPUT TRANSFORMERS** for Power or Pentode, 2/6; Multi-Ratio, 4/6; Push-Pull Input Transformers, by prominent manufacturer, 4/6 each.

PREMIER L.T. CHARGER KITS for A.C. mains, including Westinghouse Rectifiers and Tapped Mains Transformers, 8 volts at 1 amp., 14/6; 8 volts 1 a., 17/6; 15 volts 1 a., 19/-; 8 volts 2 a., 29/6. **TELSEN** iron-cored screened coils, W.349, 4/- each. Electric **SOLDERING** IRONS, 200-250 v., A.C./D.C., 2/3. **NEW 1937 1-VALVE** SHORT-WAVE RECEIVER OR ADAPTOR KIT, 13 to 86 metres without coil changing. Complete Kit and Circuit, 12/6. **VALVE GIVEN FREE!** **DE LUXE** MODEL 14 to 150 metres, complete Kit with Chassis, 4 Coils and all parts, 17/6. **1937 SUPERHET CONVERTER** KIT, 13/6. **DE LUXE** MODEL, 18/6. **S.W. SUPERHET CONVERTER** KIT, for A.C. Mains Receivers, 20/- A.C. Valve given FREE! **NEW 1937 2-VALVE** S.W. KIT, 13 to 86 metres without coil changing. Complete Kit and Circuit, 19/6. **VALVES GIVEN FREE.** **DE LUXE** MODEL, 14 to 150 metres, complete Kit and Chassis, 4 Coils and all parts, 25/- **VALVES GIVEN FREE.** **3-VALVE** S.W. KIT, S.G. Det. and Pen., 32/- **VALVES GIVEN FREE!** **BAND-PASS** TUNING PACK, comprising set of 3 Telsen iron-cored coils with switching, mounted on steel chassis with 8-gang condenser, illuminated disc-drive and 4 valve holders, 25/- the lot. All Mains or Battery circuit. **FREE!** **SPECIAL OFFER.** LISSEN TWO-GANG SCREENED ALL-WAVE COILS, 12 to 2,000 metres, complete with switching and wiring diagram, 6/11 per set. **3 VALVE BAND-PASS** KIT, 200-2,000 metres. Complete kit of parts, including chassis, all components, valves, M.C. speaker and wiring diagram. Battery Model, 50/- A.C. Mains Model, 70/- **MAGNAVOX**. Mains energised M.C. Speakers. '154', 7in. cone, 2,500 ohms, 12/6; '152', 9in. cone, 2,500 ohms, 17/6; '152 Magna', 9in. cone, 2,500 ohms, 37/6. **MAGNAVOX** P.M.s.—'254', 7in. cone, 10/6; '252', 9in. cone, 22/6. Reliable P.M.s, 10/6. **TELSEN** P.M.s with 10 ratio Transformers, 12/6. **ROLA** latest type P.M.s, 15/- **GOODMANS'** 8in. mains energised 1,000 ohms field, 10/6 each. Jensen P.M.s, 10/6. **B.T.H.** ENERGISER MOVING COIL, 10½in. diam, 1,650 ohms field. Power or Pentode Transformer. (State which.) **SPECIAL** LINE at 14/6. **Potentiometers** by well-known makers. All values up to 1 meg., 2/-; with switch, 2/6. **GRAMOPHONE MOTORS**. Collaro Gramophone Unit consisting of A.C. motor, 100-250 v. high quality pick-up and volume control, 45/-; Collaro motor only, 30/-; Collaro Universal Gramophone Motor, 100-250 v. A.C./D.C., with high quality pick-up and volume control, 67/6; Collaro Universal Motor only, 49/6; Edison Bell double-spring motors, including turntable and all fittings, 15/-; Cosmocord Gramo. unit, comprising A.C. motor pick-up and volume control (list 55/-), 35/9. **TUBULAR** CONDENSERS, non-inductive, all values up to .5 mfd., 6d. each. **Wire-end** RESISTORS, any value, 1 watt, 6d.; 4 watts, 1/-; 8 watts, 1/6; 15 watts, 2/-; 25 watts, 2/6 each. **Reliable** MORSE KEYS with Morse Code engraved on bakelite base, 2/- each. Bakelite case BUZZERS, 1/6; Walnut case, "Loud-tone," 2/6 each. **Super Quality** lightweight HEADPHONES, 3/9 pair. **UTILITY** 2-GANG MICA DIELECTRIC CONDENSERS (2 x .0005) with Uniknob Trimmers and disc drive, 3/6. **POLA STAR** 3-GANG (3 x .005) with Trimmers, fully screened, 5/6. **PREMIER** FILAMENT TRANSFORMERS, 4 v. 3 a., C.T., 7/6; 4 v. 5 a., C.T., 8/6; 5 v. 3 a., 7/6; 6.3 v. 3 a., 7/6; 7.5 v. 3 a., 7/6; 2.5 v. 8 a., 8/6.

FOR P.A. AT ITS BEST
GRAMPIAN
GRAMPIAN REPRODUCERS LTD.
Kew Gardens, Surrey

KINVA WHISTLE SUPPRESSOR
SPECIAL OFFER
SHOP-SOILED SUPPRESSORS at 3rds List Price, fully up to correct working condition; V.2 Tunable Types, 11/8 net each; Q.A.5 Tunable, 7/-; A.5 for 9 kcs, 9/-; Numerous Disc Chokes from .05 H. to 2 H., also Screened H.F. Chokes at 3rds List. Cannot be repeated when sold. List Free. POSTLETHWAITE BROS., KINVER, Staffs.

"ENGINEERING OPPORTUNITIES"
This unique Handbook shows the easy way to secure A.M.I.C.E. A. M. I. Mech. E., A. M. I. E. E., A. M. I. A. E., A. M. I. W. T., A. M. I. R. E., and similar qualifications. **WE GUARANTEE "NO PASS - NO FEE"**
Details are given of over 150 Diploma Courses in all branches of Civil, Mech., Elec., Motor, Aero, Radio and Television Engineering, Building, Government Employment, etc. Write for this enlightening Handbook to-day **FREE** and post free.
British Institute of Engineering Technology, 387, Shakespeare House, 17, 18, 19, Stratford Pl., W.1.

COMPONENTS—SECOND-HAND,
CLEARANCE, SURPLUS, ETC.

RYALL'S RADIO, 280, High Holborn, London, W.C.1. offer new goods at knock-out prices.

AMPLIFIER, with 6-watt output, 3-stage, for A.C. 200-250v., splendid chassis, Ferranti transformer, complete with 5 valves; 50/-.
3-GANG Condensers, "straight type" 0005, die cast frames, small size ex Cossor, fully screened, trimmers top, 2/9; Plessey ditto, large or small piano type, 4/6.

CLYDON Trimmers, sizes 50 mm., 70 mm., 140 mm.; 4d. each, or 2/9 dozen.

FERRANTI Coils, screened H.F., single wound, three band reaction on short wave only, with top trimmer; 1/3 each.

PLESSEY Twin Gang, fully screened with top trimmers, 0005, 3/9; ditto, semi screened, midget type, 2/9, correct hand.

CENTRALAB Volume Controls, 1/2-meg., 1/-; Centralab 11,000 ohm, 9d. each; N.S.F. 15,500 ohm, with mains on-off switch, 2/3.

T.C.C. Electrolytics, tubular can type, dry, 16x8 mid. 450v., 1/7; 4x4 ditto, post extra on this line.

N.S.F. O.I Tubular Non-inductive 1,000v. Test Condensers, 2/6 dozen, tag ends; 0.01 ditto N.S.F. 25x25 mid., six for 3/-. tubular, wire ends.

PAIRS Matched Ferranti Screened Coils, aerial and H.F., with reaction, sensitive and selective; 2/6 per pair, chassis type.

FERRANTI Mains Transformers as used in their own commercial receivers, 350-0-350v., 70 m.a., 4v. 2 1/2a., 4v. 4-5a., C.T. input 200-250v., brand new; 6/6 each. [4292]

OLIVERS Offer Erie 1-watt Resistances, colour coded, all values; 3/4d. each, 3/- dozen, 2/6 dozen in 3-dozen lots.

CENTRALAB Volume Controls, with switch, 2/- each; aluminium chassis, 18-gauge, 16in.x10in.x3in., 5/3; 16-gauge ditto, 7/6.

METAL Case Electrolytics, Dubilier 8 mid., 2/7; B.I. and T.C.C. 8 mid., 2/4; 4 mid., 2/1.

CARDBOARD Case Electrolytics, 8 mid. 1/9, 4 mid. 1/6, 8 mid.+4 mid. 2/5, 8 mid.+8 mid. 2/9, 4 mid.+4 mid. 2/-, 1 mid. 1/-, 25 mid. 25v. 1/-, 50 mid. 12v. 1/-, 50 mid. 50v. 1/6.

NON-RING End Valves, all types and replacement, lists and quotations free upon request; American type valves, including metal tubes, from 5/3 each.

GARRARD Record-changer Units, plays eight 10in. or eight 12in., complete with pick-up, etc., A.C. induction motor, 200-250v., brand new; £5/10.

OLIVERS, 676, Christchurch Rd., Boscombe, Hants. Enquiries invited; orders over 5/6 post free. Lists and valve catalogues upon application. [4278]

WARD.—For unparalleled bargains in set manufacturers' surplus; all goods are guaranteed unused and perfect; immediate delivery.

BRITISH Radiophone Condensers, fully screened, super-het, or straight types, 3-gang and 2-gang; 7/6.

CENTRALAB Resistances, 1-watt type, 6d.; 2-watt type, 1/2; 3-watt type, 1/9; B.I.C. 8mf. and 4mf. 550 volts peak electrolytic condensers, 3/3.

3,000 Brand New Wearite 110 kc. Pre-tune I.F. Transformers, type O.T.1, O.1.2 and O.T.2F.; 1/6 each, or offer for quantity.

40 mid. and 24 mid. 200 Volts Peak Electrolytic Condensers; 3/-.
 CLIX Chassis Type Valve Holders, 4- or 5-pin, 6d.; 7- or 8-pin, 6d.; R.C.A. American valve holders, 4-, 5-, 6-, or 7-pin, 9d.

ASSORTED 1-gross Parcels of 1-watt and 1/2-watt Resistances by N.S.F.; 12/-.
 MARCONI Model 25 Pick-ups; 25/-.

CONVERSION Units for Converting D.C. Receivers to A.C. Mains operation up to 110 volts, improved full-wave type; £2/10.

WESTINGHOUSE Rectifiers, L.T.4 or L.T.5, with mains transformer and variable resistance, 22/6; Varley D.P.4 output transformers, 1.1 and 25-1, 9/-.

MAINS Transformers, 350-0-350v. 60 m.a., 4v. 3 amps., 4v. 25 amps., 12/-; 425-0-425v. 120 m.a., 4v. 1 amp., 4v. 1 amp., 4v. 7 amp., 4v. 25 amp., for "W.W." Quality Amplifier, 26/-; L.T. transformers, with two 4v. 3a. C.T. windings or 2.5v. 8a., 5v. 2.5a., 8/6.

VOLUME Controls, with or without switch, by Rotorohm, Erie, Electrad, and other good makers, any value, 2/6; steel chassis, "Wireless World" Quality Amplifier, 8/6; Partridge 32-watt amplifier, 11/-.

WE Stock All Parts for "Wireless World" Quality Amplifier, Quality Amplifier Receiver, Imperial Short Wave Six, 1936 Monodial Q.A. Super, All-wave Super Seven, etc.

WE Can Supply Correct Equivalents for Any British Type of Valve, including side-contact Universals, H.F. pentodes, double diode triodes, 3.5-watt output pentodes, 500v indirectly heated rectifiers, octodes, double diodes single diode tetraodes, etc., at an appreciably lower price.

CARRIAGE Paid, cash with order or c.o.d.; send for list.

PHILIPS Amplifiers with 400v. triode in output stage; £2, complete.

WARD, 46, Farringdon St., London, E.C.4. Tel.: Holborn 9703. [0450]

UNUSED Surplus.—8in. energised speakers, Magnavox models 154 and 144, complete, 10/-; less transformer, 7/-; Cossor do., complete, 7/-; wet electrolytics, 4, 8 and 12 mids., 2/-; Vortexion filament transformer, 7 amp., 6/-; A.F.S.C. 10/-; various other lines; lists free.—Idle, Sandhurst Rd., Leeds. [4290]

OSTAR-GANZ
UNIVERSAL HIGH VOLTAGE VALVES

BUILD YOUR OWN TRANSMITTER
from OSTAR KITS with OSTAR VALVES

The only Transmitter Kit on the market.

Comprising

Crystal Oscillator Unit, Power Amplifier or Frequency Doubling Unit, Modulator Unit. Complete 15 Gns.

To enable customers to take advantage of the High Voltage Valves for the Coronation, we allow a special discount of 20% up to 15th May on all valve orders, all-wave Universal kits for receivers, radiograms and AMPLIFIERS WITH MICROPHONES; also on our regular conversion prices.

EUGEN J. FORBAT, 28-29, Southampton St., Strand, London, W.C.2. Telephone: TEMple Bar 8608-4985.

HYVOLTSTAR

SPECIAL CORONATION OFFER

enables you to take advantage of the high sensitivity of the

**Hylvoltstar Universal All-waves
A.C. and D.C. Receivers**

20% rebate in part exchange on any type of receiver, against our chassis receivers and radiograms, from 4 to 10 valves. Favourable H.P. Terms can also be allowed. Listen in to the Coronation Broadcasts from any part of the World at full loud speaker strength on any of the Hylvoltstar Receivers and Amplifiers.

Ask for our catalogue, also details of our unique battery all-mains receiver.

UNIVERSAL HIGH VOLTAGE RADIO LTD., 28-29, Southampton Street, Strand, W.C.2 Telephone: TEMple Bar 4985 & 8608

CLIX

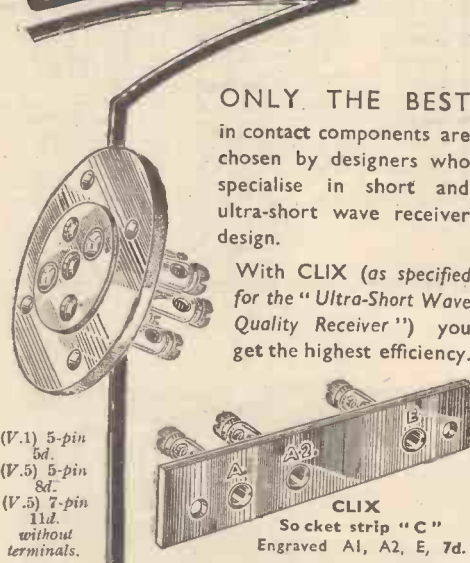

ONLY THE BEST in contact components are chosen by designers who specialise in short and ultra-short wave receiver design.

With CLIX (as specified for the "Ultra-Short Wave Quality Receiver") you get the highest efficiency.

(V.1) 5-pin 5d.
 (V.5) 5-pin 8d.
 (V.5) 7-pin 11d. without terminals.

CLIX Socket strip "C" Engraved A1, A2, E, 7d.

Yours faithfully

British Mechanical Productions, Ltd., incorporating the business formerly carried on by

LECTRO LINX LTD.
79a Rochester Row, London, S.W.1

COMPONENTS—SECOND-HAND,
CLEARANCE, SURPLUS, ETC.

MAINS RADIO DEVELOPMENT Co. Offer Several Exclusive New Lines; carriage paid; call mornings, phone Tudor 4046; stamp for new list.

MAGNUM Fully Screened Three-wave Band Superhet. Coils, and I.F. transformers, surplus to set maker; latest type grey cellulose cans, trimmers on all wave bands, 15-52, 190-560, 800-2,200 metres; aerial (for pre H.F.), H.F. and oscillator (465 k/c.); three coils, two 465 k/c. I.F.'s, and three-gang Yaxley type switching; complete kit, with circuit diagram, 25/-; without I.F. transformers, 17/6.

ERIE Surplus Quarter Watt Resistors, two each of six good sizes, our choice, 1/- dozen; colour coded, wire ends.

SATOR Metal Cased Condensers, 400 volt working. 1 mid., 7/4d.; 2 mid., 10d.; 4 mid., 1/8; Formo tag condensers .0001 to .002 mid., 1/4d. each.

CENTRALAB 500,000 Ohms Unused Potentiometers, 1/-; any size, with or without switch, 2/3; Rotorohm 10,000 ohms with switch, 1/6; Wearite H.F. chokes, 6d.

TUBULAR Condensers, very best make, wire ends, 400 volt working. .0001-.0002 mid., 3d; .005-.05 mid., 5d.; .25, .5 mid., 7d; special offer .1 mid., 450 volt working, 5d.

RESISTORS, absolutely finest make, one watt, wire end, colour coded, unused, 50 ohms, to 5 megohms, any size, your choice, 3/4d., 2/9 dozen; two watt, any size, 6d.

CLIX Latest Unused Chassis V-holders, 4-pin, 1/4d; 5-pin, 2/4d.; 7-pin, 4d.; 9-pin, 6d.; chassis, grey cellulose metal; three-valve, 12 1/2 x 6 1/2 x 3in., 1/-.

PYVE, 20h. 120 m/a boxed L.F. chokes, 4/6; Steatite S.W. condensers, 0.00016 mid., boxed, 1/6.

REDUCTION OF B.I.C 8 mid, 550 v. metal can elec., 2/3; ten other sizes on list.

MAINS RADIO DEVELOPMENT Co., 4-6, Muswell Hill Rd., N.6, London. All goods unused. [4131]

GENUINE Bargains! Amateur, giving up radio, must sell; satisfaction or money back; valves, mains equipment, Ferranti transformer, Ferrocast coils, gram-motor, Ekco radio-recorder and microphone, H.T. battery, charger, etc.; write for list, post free.—Lavender Cottage, Bramber, Sussex. [4270]

NEON Tuners, pin base, 1/9; S/H 500,000 ohm volume control, W/F switch, 9d.; T.C.C. electrolytic condensers, 16 mid. 2/6, 8 mid. 2/3; 25-volt 25 mid. 1/3; large selection of component parts in stock; 10% discount on orders of £1.—Radio Trade Service, 43, Hetley Rd., Shepherd's Bush, W.12. (She. 3567.) [4276]

GRAMOPHONE Attachments for Radio.—Electric motors, 25/-; pickups, 9/6; portable gramophones, 12/-; spring motors, 4/6, dozen 36/-, 100 £12/10, 1,000 £100; walnut pedestal Anexasgram, £25; soundboxes, tone arms, horns, cabinets, needles, gears, springs, accessories cheapest; quantity buyers obtain lower prices; catalogue free.—Regentworld, 120, Old St., London, E.C.1. [4213]

TRANSMITTING APPARATUS

G5N1.—The recognised distributors for amateur equipment, National, R.M.E., Thordarson, Hammarlund, McMurda, Mullcrafters, etc.; send 1/4d. stamp for catalogue.—Radiomart, 44, Holloway Head, Birmingham. [0531]

MISCELLANEOUS

CHEAP Printing.—1,000 hillbeads, 3/6; sample free.—Cretaway Press, 18, Buxted, Sussex. [4113]

G.P.O. Engineering Dep. (no experience required); commencing £3/15 per week; age 18-23; excellent prospects.—Free details of Entrance Exam. from B.I.E.T. (Dept. 574), 17-19, Stratford Place, London, W.1. [4160]

AMBITIOUS Men.—To ensure promotion take advantage of The T.I.G.B.'s authoritative home study courses in Radio Engineering and Servicing, Television, Sound Recording, Wireless Communications, etc.; write to-day for "The Engineer's Guide to Success"—free—which gives full particulars—contains the world's widest choice of engineering courses covering all branches—and alone gives the Regulations for qualifications, such as A.M.I.E.E., A.M.I.R.E., A.M.I.T.E., A.M.I.W.T., C. & G., etc. Training until successful guaranteed.—The Technological Institute of Great Britain, 5, Temple Bar House, London, E.C.4 (Founded 1917. 20,000 successes.) [4148]

EXTENDED PAYMENTS

LONDON RADIO SUPPLY Co. (Established 1925) supply on convenient terms, components, accessories and sets, any make, 10% down, balance over 12 months; send for list of requirements.—11, Oat Lane, London, E.C.2. [0337]

HIRE-PURCHASE—Prompt delivery of any radio apparatus on convenient terms.
 WARD, 46, Farringdon St., London, E.C.4. Tel.: Holborn 9703. [0539]

ELECTRIC CLOCKS

SMITHS and Ferranti Electric Clocks, Waltham and Russell watches and clocks; trailers' enquiries invited.—Leonard Heys, 36, Henry St., Blackpool. [0526]

EXCHANGE

I BUY, sell, exchange good quality receivers, accessories, components; H.P. facilities; promptness, efficiency.—Bostock, 1, Westbourne Terrace, S.E.23. Forest Hill 2236. [0529]

PATENT AND TRADE MARK AGENTS

GEE and Co. (H. T. P. Gee, Mem. R.S.G.B., A.M.I.E.E., Estab. 1905), 51-52, Chancery Lane, London, W.C.2 (2 doors from Government Patent Office). Holborn 4547 (2 lines). Handbook free. [0001]

RAYMART CRAFT A CREED

THE JOHNSON TYPE "Q"

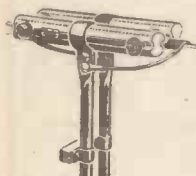

ANTENNA SYSTEM

The Johnson Type "Q" has achieved outstanding success in high-frequency transmitters throughout the world because of its high efficiency.

The special quarter-wave tubing transformer accurately matches line and antenna impedances, and power is transferred with practically no losses even with very long lines. Due to these factors, the type 'Q' will radiate TWICE as much power as the common non-matched antenna-feeder system. The 'Q' may be installed on long-wire harmonic radiators as well as on the suggested half-wave doublet.

- TYPE 10 Q** for 10-metre operation..... **26/6**
TYPE 20 Q for 20-metre operation..... **39/6**
Deliveries from stock.

RAYMART SHORT-WAVE MANUAL contains practical circuits and data on Short-wave Receivers, transmitters, modulators, transceivers, etc., including information on transmitting licences, "class B" modulation, aerials, etc. Price with enlarged Short-Wave Catalogue 6d., or 7d. post free.

MICROVARIABLES.—All brass construction, latest ceramic insulation. The finest condensers made: 15 mmfd., 1/4; 40 mmfd., 1/7; 100 mmfd., 1/10; Transmuting Type.—0.70 in. spacing, 15 mmfd. (neutralising), 2/8. 40 mmfd. Tuning, 3/6. These are quality.

SHORTWAVE COILS.—(RD.4) CA 11-25, CB 20-45 metres, 2/8. CB 40-100 metres, 2/8. Standard 6-pin types, C6A, C6B, 2/8 each; C6C, 3/-; same range as 4-pin.

COILFORMS.—Moulded in RD.4 natural latex material, hollow resilient plus, 1 1/4 in. diameter, ribbed; identification disc in top. Four types, 4-pin, 1/6; 6-pin (standard or to fit 7-pin valveholders), 1/9; 7-pin (for handbread top), 1/10; Machine threading, 2d. extra.

AMERICAN Mains Transformers. 230 v. primary, fully shrouded, A 350-0-350, 6.3 v., 5 v., 6.11; Ditto, heavy duty up to 10 valves 150 m.a., weight 8 lbs., 12/6; Majestic, 250-250 2.5 v., 3 v., 4.11; Pilot 280-260, 2.5 v. C.T., 5 v. C.T., 5.11. Ceramic American Valveholders, 1/- each.

HEAVY DUTY Mains Transformer, worth 35/-, 350-250, 150 m.a., 4 v., 2.5 A., C.T., 4 v., 6 A. C.T., 12/6; Philips 270-270, 120 m.a., same L.T.s., 6/8; Speaker Transformers, 2/6.

UTILITY 8/6, Microdisc Dials. 3/11; Radiophone, 0.00016 Shortwave Condensers, 3/6; Series gap twin, 3/8. Shortwave HF Chokes 5-100 metres, 8d.

EC Litz Wound I.P.s. 3/11; Two-speed slow-motion knobs, 1/-; 465 Telsen Ace Transformers, 1/11; Telsen Screened 8.W. H.F.C., 1/-; Iron core H.F. chokes, 1/-.

ELECTROLYTICS. Huge purchase 500 v. Aluminium Cap., 4 mf., 1/6; 8 mf., 1/11; 8+8 mf., 2/6; Block type, 500 v. peak, 4+4 mf., 1/6; 8+8+4 mf., 3/-; 30 mf. 50 v., 1/3; 25 mf. 25 v., 1/5; Tubular Condensers, 1,500 v. T., all sizes to 0.1 mf., 6d.; 0.2 to 0.5 mf., 8d.

FAMOUS CONTINENTAL A.C. Valves, 4/6; Battery types from 2/3; American Duotrons, etc., all types, 3/6; All types of RCA Licensed first grade tubes, metal and glass, in stock from 5/6.

BRITISH RADIOPHONE. 0005 straight or superhet 3-gang fully screened condensers with trimmers, 4/11; Utility Midset 2-gang ditto, 3/11; 8 L. Dial to suit above, 2/11; Utility 2-gang Uniknob 0005 with Dial, 3/11.

PUSHBACK Wre. 6 yds., 6d.; heavy, 9d.; Resin-cored Solder, 6t., 6d.; Screened Flex, single, 6d. yd.; twin, 9d. yd. Assorted Solder Tags, 6d. packet.

SMOOTHING CHOKES, 20 by., 120 m.a., 3/11; 200 m.a. swiveling chokes, 8/8; Centratub Pots, all sizes, 1/6; switched, 2/-; 20,000 ohm Pots, 1/-; Tubular glass fuses, 2d. Milliammeters, 25 m.a. upwards, 5/9; super, 8/9.

SPECIAL OFFERS. Class B Kit, worth 30/-, comprising Driver Transformer, Valve and Holder, 5/-; Dozen wire-ended assorted resistors, 1/6. Order 5/- post free. Get our Bargain Catalogue, 11d. post free. All enquiries and requests for Catalogue must send 11d. stamp.

BIRMINGHAM RADIOMART (G5N) 44, HOLLOWAY HEAD, BIRMINGHAM. TELE: MID. 3254

REPAIRS AND SERVICE

G^RAHAM'S.

G^RAHAM'S Radio, Repair and Rewinding Service; 24 hours' service guaranteed.—See below.

ALL Moving Iron Loud Speakers, L.F. transformers, or pick-ups, from 2/6, output transformers from 4/-; postage extra; mains transformers, moving coils, electric clocks quoted, trade discounts.—Graham's Repairs, 194-Tolworth Rise, Kingston By-pass, Surrey. Phone: Derwent 2060. [4141]

DISTAVOX SERVICE.

GUARANTEED Service.—All makes of English and American receivers; quotation by return.

REWINDING.—Mains, L.F. and output transformers, speakers, headphones, etc.; keenest terms for contracts.

DISTAVOX RADIO SERVICE Co., 119, Bunhill Row, London, E.O.1. Phone: National 8589. [4142]

'SERVICE WITH A SMILE.'

HENRY FORD RADIO, Ltd.—American valves, components, spares, line cords; leading trade repairers; send us your American and British receivers.—Electronic House, 22, Howland St., Tottenham Court Rd., W.1. Museum 5675. [0434]

RELIABLE, Prompt Repairs to any type of receiver.—Wilkinson, 117, Morley Hill, Enfield. [4283]

METROPOLITAN RADIO SERVICE Co., for Guaranteed Repairs to American (Midget and Standard and British Receivers).

CLARION and Majestic Service Depot.—L.F. and mains transformers re-wound, American valves and parts; trade supplied.—Metropolitan Radio Service Co., 1021, Finchley Rd., London, N.W.11. Speedwell 3000. [0435]

REPAIRS, rewinds, and construction, any size transformers, chokes, etc., to trade.—Electric, Garden St., Sheffield, 1. [3915]

FOR Unusually Good Rewinding of Transformers, chokes, speakers, etc., trade only.—Gardners Radio, Ltd., West Southbourne, Bournemouth. [0551]

OUR Technical Department is at your Service.—Air King Radio, 115, Shaftesbury Av., Cambridge Circus, W.C.2. Phone: Temple Bar 4875 (2 lines). [3963]

LOUND Speaker Repairs, British, American, etc.; any make transformer coils rewound; alterations.—Sinclair Speakers, Alma Grove, Copenhagen St., N.1. [4030]

NATIONAL RADIO AND TELEVISION SERVICE Co. Leading Service Engineers and Car Radio Experts, 155-157, Great Portland St., W.1. Phone: Langham 3477. [3911]

GUARANTEED Repairs.—Any transformers, choke, motor, armature, converter, dynamo, etc.; keenest prices, immediate quotation; prompt, dependable service.—See below.

LT.P. (LONDON TRANSFORMER PRODUCTS, Ltd.), Willesden, N.W.10. Willesden 6486 (3 lines). [3470]

POULTNEY and PURVIS, British and American Service, trade or private; "W.W." sets a speciality; free collection, estimates.—147, Pittshanger Lane, Ealing, W.5. Percival 3765. [4147]

MAINS Transformer Service.—Repairs, rewinds, or constructions to specification of any type; competitive prices and prompt service.—Sturdy Electric Co., Dighton, Newcastle-on-Tyne. [0516]

F. E. GODFREY, A.M.L.R.E., qualified to build, repair and convert "Wireless World" sets, etc.; 25 years' experience; prompt service guaranteed.—30, Kemplay Rd., Hampstead, Hampstead 1104. [3509]

ZETAVOX, Zenith, repairs, conversions; specialists in stallation and repairs car radio; trade service; public address, coil winding; sets designed.—Zetavox, 4, Colebrooke Place, Islington. Can. 1172. [4277]

ALL British or American Sets Repaired or Modernised by Qualified Engineers; satisfied customers throughout the world are your guarantee; send to-day for free estimate; free collection 10 miles radius of London.—Scott-Sessions and Co., Exchange Works, Dukes Av., Muswell Hill, London, N.10. Phone: Tudor 4101. [0552]

REPAIRS to Moving Coil Speakers a Speciality; cones and coils fitted, fields altered; prices, including eliminators, quoted, loud speakers, 4/-; L.F. and output transformers, 4/-, post free; guaranteed satisfaction; trade invited; estimates free; prompt service.—Loud-Speaker Repair Works, 5, Balham Grove, London. Battersea 1321. [0394]

PATENTS

"PRACTICAL Hints on Patents," free on application, The Imperial Patent Service, First Avenue House, High Holborn, W.C.1. Preliminary consultation free. [0481]

TUITION

RADIO Training.—Marine, aircraft, broadcast; prospectus free.—Hull Municipal Technical College. [0523]

PRACTICAL Radio and Television, private or postal training; particulars free.—R.T.I., 39-47, Earl's Court Rd., W.8. Western 6917. [3758]

WANTED

ELECTRODYNAMIO Converter, input 24v., output 250-50v., 200w. A.C.—Birch Grove P.O., Sussex. [4289]

WANTED, all types modern radios, chassis and apparatus.—Write H. R. Radio, 41, Hettle Rd., London, W.12. [4248]

WANTED, Ferranti transformers, meters, Avo testing equipment, etc.—Grigg, 70, Peel Rd., Waltham, Middlesex. [4285]

WE Buy for Cash All Types of Modern Second-hand Radio Sets and Accessories, test meters, parts, etc.; we pay more than any other dealer; part exchanges; bring, send, or will call.—University Radio, Ltd., 82, Hampstead Rd., London, N.W.1. Phone: Euston 3810. [4193]

Specified for the ULTRA SHORT WAVE QUALITY RECEIVER

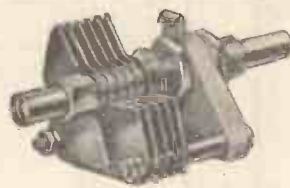

'APEX ECONOMY' CONDENSERS

15 mmfd 1/6. 40 mmfd 1/9
All other parts in stock

WEBB'S RADIO

The recognised London Suppliers
to AMATEUR EXPERIMENTERS

14, Soho Street, Oxford Street, London, W.1.
Telephone: GER. 2089

ELECTRADIX BARGAINS

TELEPHONES for HOUSE, OFFICE, GARAGE, and Field Sports. Table Wall and Waterproof Portable, from 10/-. Headphones for short-wave radio, etc., 2/9 pair. Telephone wire cheap.



MOTORS! MOTORS! Tiny, Small and Medium horse-power. We have a large stock of really high-grade Motors, Dynamos and Alternators for immediate delivery. Battery Motors, A.C. Mains Motors, 100/250. D.C. Mains Motors, 50/250 at prices from 15/-. See list. Rotary Converters from 37/6. 10 amp. Charging Dynamos, 25/-.

PUMPS AND COMPRESSORS.

Coronation Fountain Electric Pumps, for A.C. or D.C. mains. Centrifugal, all-bronze pump, 3ft. lift, 120 gals. per hour. For 6ft. fountain, etc., 67/6. Larger pumps quoted for. **AIR COMPRESSORS** for Paint Spraying. Set Cleaning, Inflation, Electric drive or manual, etc. Foot Operated, 37/6. 230 v. Electric No. 1 size, 25/15/-. High Pressure Blowers. **CORONATION LIGHTING.** Strand 12 circuit contact flasher with 60-1 gear box and a G.E.C. 3 circuit ditto motor driven. Large Neon decoration on panel coloured Butterfly with transformer 230 v. mains. 220 v. 5 watt bulbs, 5/- doz. **SEARCH LIGHTS and FLOOD LIGHTS,** Cable Resistances, etc. Porcelain Cleats, 6d. pair. **ELECTRIC LIGHT,** 1,000 Porcelain Ceiling Roses with Ramie Junction Connectors, 5/- doz.

HOME RECORDING

at low cost. Electric FEIGH set has ball bearing centre gear box and geared traverse rod. Price with Tracking Gear, Pick-up and 37/6 Tone-arm with diamond... 37/6 For experimenters requiring gear only, less Pick-up and Tone Arm, this is 21/6. Diamond Cutter Needles, fit all pick-ups, 7/6. Blank Discs, 4/- dozen. Complete Acoustic Sets de Luxe, 21/-; No. 2, 12/6; Junior type, 7/6 each, complete.



MICROPHONES

"W.W." No. 11 **TABLE MIKE.** A splendid Microphone for speech and music. Bakelite case, containing a 2in. transmitter and transformer, on bronze pedestal, detachable Switch and plug. Unrivalled for quality and price, 15/- (as illus.). Other types; **Lesdix No. 10B** Pedestal, 10in. high, 12/6; **Lesdix Superior No. 12BB** Ring 14in. Pedestal, 18/6. Hand Mikes in 2in. case, No. 11 at 5/6; Superior type No. 11A, 7/6. Buttons, 1/-; Eisler public address and band Mike (Reisz principle), 55/-. Ask for Illustrated Mike List "W" of 25 models. Our famous PARTS for making your own mike. Carbon Granules in glass capsule: Grade 1, 8d.; No. 2, 1/2; No. 3, fine, 1/6; No. 4, extra fine, 7/-; Black Blocks, 4d.; Diaphragms, thin carbon, 6d.; Button in 1 1/4 in. hard wood case with 2in. mica diaph., 2/6; Ditto, mounted on pedestal, 3/6. **PHOTO CELLS.** R.C.A. UX867, Talkie model, 25/-. Few Osram C.M.G., 35/-; Selenium Raycraft, 21/-; Photronic Self Gen. Cells, 25/-; X-Ray Tubes NA 3-guinea tungsten electrodes, 10/-; Ray Plate Holders, famous make, 2/8 & 5/-; **TIME SWITCHES,** Switch on-off any time, 6 amps., 35/-; 10 amps., 40/-; 25 amps., 55/-.

1,000 other bargains in New Sale List "W," post free.

ELECTRADIX RADIOS
218, UPPER THAMES STREET, LONDON, E.C.4
Telephone: Central 4611

RECORD
The quality valve in the COMPLETE range
RECORD RADIO LTD., 2/3, Eldon Street, E.C.2

TANNOY
THE SOUND PEOPLE
GUY R. FOUNTAIN LTD.,
FOR CANTERBURY GROVE, WEST NORWOOD,
ALL LONDON, S.E.27. Phone: Str. 4122 (6 lines).
SOUND AMPLIFYING EQUIPMENT

★ PRAISE FROM THE PRESS CLUB
for Savage Sound.....

Dear Sir,
I am desired by my committee to tender you sincere thanks for the splendid installation of public address equipment recently installed in our dining room by you, not only for the very workmanlike manner in which your engineers carried out the work, which your representative which has resulted in perfect reproduction.
My committee and members are full of praise for the amazing improvement this has made at our house dinners.
Yours faithfully,
A. LAZENBY,
Manager-Secretary.



WESTMORELAND ROAD, LONDON, N.W.9
PHONE: COLINDALE 7131 (3 LINES)

WEARITE ALL-WAVE OSCILLATOR UNIT

Covers all wavelengths from 15 M. to 3,000 M. in 7 ranges (harmonics not used).
MODULATION. May be switched off and external modulation used when required.
SHIELDING. Minimum leakage, no appreciable energy reaches the set.
STABILITY. Calibration permanent for all variables.

SITUATIONS VACANT

K EEN Service and Sales Engineer; only competent men need apply.—Manor Radio, Ruislip Manor, Middx. [4271]
SERVICE Engineer Required for Service Depot; must be thoroughly efficient.—Write particulars, salary, etc., Box 1606, c/o The Wireless World. [4295]
TWO Youths Required for Servicing, wiring, assembling experimental receivers; experience essential; state age and salary required.—Box 1593, c/o The Wireless World. [4275]
WANTED, junior assistant for routine checking in works laboratory, secondary or technical school education, age approximately 18 years; London, Hendon district.—Box 1571, c/o The Wireless World. [4267]
RADIO and Television.—Wanted, first class testers with factory experience, able to diagnose faults quickly and accurately; write, stating experience, age and salary required.—Box 1567, c/o The Wireless World. [4258]
RADIO Valve Experimental Assembly Maker Required (Manchester District), experience on valve work essential.—Reply giving age, qualifications, previous employers and wage expected to Box 1569, c/o The Wireless World. [4260]
WIRELESS Operators and Engineers Urgently Required.—Train at Britain's leading colleges; fee after appointment; boarders; prospectus free.—The Wireless College, Colwyn Bay, or The Wireless College, Calmore, Southampton. [0541]
RADIO Manager Required by Large Works, A1 man only, age 40-50, thoroughly experienced in engineering, manufacturing and market trends; give full particulars of experience, age, present salary and salary expected; enclose small unmounted photograph.—Box 1373, c/o The Wireless World. [4162]

BOOKS, INSTRUCTION, ETC.

"WIRELESS World," 1922-1934, bound; "Experimental Wireless," volumes 1-3, bound; what offers?—Box 1578, c/o The Wireless World. [4269]

PETO-SCOTT

SERVICE Peto-Scott not only supply kits of parts of all "Wireless World" sets, but they have also specialised for 18 years in the construction of "Wireless World" Finished Receivers. You may therefore order from us with complete confidence in the knowledge that each Kit or instrument we supply is backed by our guarantee of satisfaction.

"Wireless World" Ultra-Short Wave QUALITY RECEIVER

KIT "A" CASH OR C.O.D. £4:7:6
Carriage Paid.
Or 8/- down and 11 monthly payments 8/-.

Comprises Peto-Scott ready-drilled Chassis and Screens with all components to specified values, including 2 B.T.S. ready-wound Coils and 3 Tuning Condensers, less Valves.

KIT "B" As above, but with 3 Valves. £6:4:0
Cash or C.O.D. Carr. Paid.
Or 11/- down and 11 monthly payments 11/6.

FINISHED INSTRUMENT Peto-Scott Version
Constructed throughout to Values specified by "Wireless World." Highest grade British components. Individually built and tested by Peto-Scott technicians. Complete with Valves, less £6 Cabinet and Amplifier. Cash or C.O.D. Carr. Paid.

Or 11/- down and 11 monthly payments 11/-.
Peto-Scott Chassis

Ready-drilled Chassis and Screens (20-gauge steel) finished stove-enamelled grey. Post Free. 12/6

B.T.S. Ready-Wound COILS
Wound exactly to "Wireless World" specification. Rigidly tested for maximum efficiency. Per Pair 4/6

PUSH-PULL QUALITY AMPLIFIER

COMPLETE KIT of parts, less valves only. £10:3:0
Cash or C.O.D. Carr. Pd.

Or 18/6 down and 11 monthly payments 18/6.
If Valves required, add £3:1:0 to Cash Price or 5/7 to deposit and each monthly payment.

FINISHED INSTRUMENT with valves, £15:6:0
less cabinet. Cash or C.O.D.
Or £2:6:0 down and 11 monthly payments 26/-.

COMPLETE Ultra-Short Wave RECEIVER with PUSH-PULL QUALITY AMPLIFIER Peto-Scott Version
as detailed above and complete with all valves, less £21:6:0 cabinet. Built and tested by Peto-Scott technicians.
Or £3:6:0 down & 11 monthly payments of £1:16:0

If MAGNAVOX DUODE 33 SPEAKERS required with any of above kits or instruments, add £5:5:0 to Cash Price or 9/7 to deposit and each monthly payment.

All Postal Orders must be crossed and currency registered.
PETO-SCOTT Co. Ltd., Established 1919
77 (W.W.24), City Road, London, E.C.1.
62 (W.W.24), High Holborn, London, W.C.1.

INDEX TO ADVERTISEMENTS

	PAGE
All-Power Transformers, Ltd.	Front Cover
Automatic Coil Winder Co., Ltd.	4
Baker's Selhurst Radio	3
Belling-Lee, Ltd.	7
Birmingham Radiomart G5N1	5
British Institute of Engineering Technology	1
British Insulated Cables, Ltd.	5
British Rola Co., Ltd.	Edit. 411
British Sound Recording	
British Thomson-Houston Co., Ltd.	
Bulgin, A. S., & Co., Ltd.	
C.A.V.	Front Cover
Colvern, Ltd.	
Coscor, A. C., Ltd.	
"Drydex"	
Dubilier Condenser Co. (1928), Ltd.	Inside Front Cover
Electradix Radios	7
Exide, Ltd.	

	PAGE
Fluxite	
Forbat, Eugene J.	6
Gardners Radio, Ltd.	
Goodmans, Ltd.	1
Gramplan Reproducers, Ltd.	5
Hartley Turner Radio, Ltd.	2
Haynes Radio	Front Cover
Henley's W.T. Cable & Wireless Works	
Institute of Wireless Technology	
Lectro-Linx, Ltd.	6
McCarthy Radio, Ltd.	Edit. 407
Midwest Radio, Ltd.	8
M.P.R. Electrical Co.	
M.R. Supplies	
Parmeko, Ltd.	

	PAGE
Peto-Scott, Ltd.	8
Player's Cigarettes	
Postlethwaite Bros.	5
Premier Supply Stores	5
Record Radio, Ltd.	7
Savage, W. Bryan	
Scott Sessions, Ltd.	8
Shaftesbury Microphones	
Sound Sales, Ltd.	Front Cover
Stern, S.	
Tannoy Products	7
Telegraph Condenser Co., Ltd.	Edit. 409
Universal Radio Distributors, Ltd.	
Ward, C. F.	
Webb's Radio	7
Wright & Weaire, Ltd.	8

FREE ART CATALOGUE DEMONSTRATIONS 40 pages, fully illustrated, giving particulars of Midwest 11, 14, 16, and 18 valve models. at our showrooms Mondays to Saturdays from 9 a.m. to 8 p.m. (except Tuesdays, 9 a.m. to 6 p.m.).

1937 MIDWEST

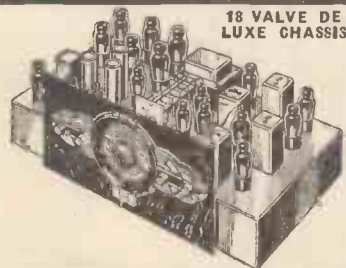

Magnificent alike in its conception, design and performance, this the latest Midwest Model X-18 High Fidelity Receiver brings the world to your fire-side. With its 6 TUNING RANGES it gets "Everything on the Air." Its distinctive features in circuit design are not just "talking points," as a comparison will prove, but basic advantages which will assuredly appeal to "Wireless World" readers and all who appreciate Studio or Concert Hall quality of performance in the home.

MIDWEST RADIO Ltd.

Showrooms and Factory:
16, Old Town, Clapham, London, S.W.4.
Phone: MA04nlay 5005.

THE ONLY ALL-WAVE RECEIVER COVERING 4 1/2 to 2,400 METRES
Available in Chassis form complete with matched valves and 12" speaker or in Console Cabinet.

FIFTH EDITION

--Revised and Enlarged

HANDBOOK of TECHNICAL INSTRUCTION for WIRELESS TELEGRAPHISTS

By H. M. DOWSETT, M.I.E.E., F.Inst.P., M.Inst.R.E.

Provides a complete theoretical course for students wishing to qualify for the Postmaster-General's Certificate of proficiency. Additional chapters included in this new edition are those on Echo Sounding Apparatus, Short-Wave Marine Transmission and Reception, Marine Telephony and Band Repeaters—all recent developments which concern the sea-going operator. All sets in general use (Marconi, Siemens, Radio Communication) are also described.

PRICE 15/- net. By post 15/9

Obtainable from all leading booksellers or direct from the publishers
LILFE & SONS LTD., DORSET HOUSE, STAMFORD STREET, LONDON S.E.1

W.W.96

FOUNDATIONS of WIRELESS

*A Book of
First Principles
for the
Wireless
Enthusiast*

PRICE 4/6 NET
By Post 4/11

Issued in conjunction with
"THE WIRELESS WORLD"
and published by the Proprietors—

By A. L. M. SOWERBY, M.Sc.

An Elementary Text Book on Wireless Receivers

"Foundations of Wireless," based on a series of articles which appeared in "The Wireless World," covers the whole field of wireless from the simplest electrical phenomena to the construction of a modern set, and all the vital points in receiver design are treated in full detail. Chapters are devoted to direct and alternating currents; typical circuits; the properties of inductance and capacity; the nature of high frequency currents; the tuned circuit; and amplification by the valve.

Eleven of the eighteen chapters of the book deal with the discussion of receivers, in which the whole process of design is reviewed stage by stage to the finished article.

Special attention is paid to the important subject of tuned circuits and band-pass filters, on the correct design of which the performance of every type of set ultimately depends. Moreover, the process of detection, so often imperfectly understood, is clearly explained.

ILIFFE & SONS LTD., DORSET HOUSE, STAMFORD STREET, LONDON, S.E.1

RADIO RECEIVER MEASUREMENTS

By Roy M. Barnard, B.Sc., A.M.I.R.E.
(1934)

Although primarily designed for the benefit of the radio service engineer, this concise handbook is also of practical value to the amateur experimenter.

It describes the methods of measuring receiver performance and provides provisional standards as a basis for judging performance. Measurements of sensitivity, selectivity and fidelity are explained at length and the interpretation in estimating receiver performance is carefully set out.

Details are given of methods of receiver testing with full descriptions of commercial signal generators and their application to the adjustment of superheterodynes and "straight" receivers.

*Complete with fifty-three illustrations
and diagrams, summaries of method,
four appendices and a general index.*

PRICE 4/6 net By post 4/9

From all booksellers or direct from the Publishers

ILIFFE & SONS LTD., DORSET HOUSE, STAMFORD STREET, LONDON, S.E.1
W.W.19

Mention of "The Wireless World," when writing to advertisers, will ensure prompt attention.

SECOND EDITION

—THOROUGHLY REVISED

WIRELESS SERVICING MANUALBy **W. T. COCKING**

(of "The Wireless World")

The first complete book of reference of its kind. A reliable practical guide for amateur and professional.

The demand for this book was so great that the first edition was sold out in the short space of a very few months. A second edition containing additional material is now on sale. The "Wireless Servicing Manual" deals fully with Testing Apparatus and explains the methods of locating and curing faults in receiving equipment.

Ganging, Automatic Volume Control, Instability, Distortion, Mains Hum, Whistles and Local Interference are all separately treated.

The new edition contains much additional information on short-wave receivers, and on methods of operating extension loud speakers, the reference material including base-connections for British, Continental and American Valves and the various colour codes for components has been extended and brought up to date

BOUND IN CLOTH BOARDS

SIZE 7½ ins. × 5 ins.

231 PAGES

PRICE 5/- net. By post 5/4

Issued in conjunction with "THE WIRELESS WORLD" and Published by the Proprietors:—

ILIFFE & SONS LTD., DORSET HOUSE, STAMFORD STREET, LONDON, S.E.1

W.W. 20

Second Edition—

Completely Revised

RADIO DATA CHARTS**A SERIES OF ABACS***providing most of the essential Data required in Receiving Design*By **R. T. BEATTY, M.A., B.E., D.Sc.**

Published from the Offices of "THE WIRELESS WORLD."

RADIO DATA CHARTS provide designers of wireless apparatus with a ready, convenient means of solving all the more familiar problems connected with the design of modern radio apparatus without having recourse to complicated formulae and mathematics.

In order to keep abreast of the great advances in wireless communications since the first edition of "Radio Data Charts" appeared, obsolete abacs have been omitted in this second edition and important fresh material added.

By the use of the present edition of "Radio Data Charts," such abstruse problems as the design of tuning coils are solved almost as easily as the simple application of Ohm's Law.

Price 4/6 net By post 4/10

(37 CHARTS and 46 Diagrams)

From all leading booksellers or direct from the Offices of

"THE WIRELESS WORLD," Dorset House, Stamford Street, London, S.E.1

W.W. 93



4^D

The Wireless World

THE PRACTICAL RADIO & TELEVISION JOURNAL

Friday, April 30th, 1937.

See the new McCarthy models first!

The new range of McCarthy all-wave receivers include many improved features, giving still better performance. Prices include Marconi Royalties.

There are also several exceptionally interesting new models of an advanced type. Write for the McCarthy Catalogue, containing illustrations, full specifications, circuit diagrams, also details of loud speakers, cabinets, etc., to:—



MCCARTHY
RADIO LTD.

44a, Westbourne Grove, London, W.2
Telephone: Bayswater 3201/2.

SEE ADVERTISEMENT INSIDE →

TYPE F. METALLISED RESISTANCES



Type	Watt	Max. Volts	Length	Dia.	Min. Res.	Max. Res.	Price each
F $\frac{1}{2}$	$\frac{1}{2}$	500	1"	$\frac{3}{32}$ "	50 Ω	10M Ω	6d.
F1	1	700	1 $\frac{1}{8}$ "	$\frac{1}{16}$ "	100 Ω	10M Ω	1/-
F2	2	700	2 $\frac{5}{16}$ "	$\frac{7}{16}$ "	50 Ω	5M Ω	2/-
F3	3	700	2 $\frac{1}{8}$ "	$\frac{1}{8}$ "	100 Ω	5M Ω	3/-

DUBILIER

Dubilier Condenser Co. (1925) Ltd., Ducon Works, Victoria Rd., North Acton, W.3
O. R. Osborn 6

Everything for

QUALITY RECEPTION



Everything for the

TELEVISION CONSTRUCTOR

Duophase amplifier 6-watt, Duophase amplifier 6-watt for P.M. speaker, Duophase amplifier 14-watt, Duophase amplifier 14-watt (constructor's model), Duophone amplifier circuits, Duophase intervalve coupling, gramophone amplifier 6-watt, gramophone amplifier 14-watt, 1-H.F. tuner unit, 2-H.F. tuner unit, all-wave tuner unit, shortwave converter, table model receivers, radiogramophones, schools receivers, baffle boards, loud speakers, volume controls, mains transformers, smoothing and filter chokes, output transformers

Originators of the Quality Receiver and Quality Radiogramophones.

Demonstration night every Friday, 7.30-9.30 p.m.

Time base transformers, time base units, H.T. transformers up to 6,000 volts, heater transformers, smoothing and voltage regulating equipment, high voltage rectifiers, cathode ray tubes and holders with protecting front screen, converter units for speech reception, complete apparatus for vision receiver construction, chassis and special baseplates.

The most attractive development ever presented to the radio enthusiast.

Have you the Haynes Quality Booklet? 1936-37 Edition. Free on request. Howard 1171.

HAYNES RADIO LIMITED, QUEENSWAY, ENFIELD, MIDDLESEX.

TOUR THE WORLD *with* "HIS MASTER'S VOICE" *Coronation Year* RADIO

THERE are "His Master's Voice" Coronation Year All-World radio receivers and radiograms which will reproduce with amazing realism programmes from U.S.A., Australia and other distant parts of the world.

The famous "His Master's Voice" cabinet work has never been so strikingly apparent as in these superb acoustically designed instruments—delightful as pieces of furniture, and each ideal for the instrument of which it forms an integral part.



RADIOGRAMS



488 AC. All-World Superhet Radiogram. 6 valves. Five wave ranges: 7-16 (covers Television Sound Transmission), 16.7-53, 46-140, 185-560, 750-2200 metres. 29½ gns.



495 AC. All-World Superhet Radiogram. 6 valves. Three wave ranges: 16.5-52, 195-580, 725-2000 metres. 22 gns.

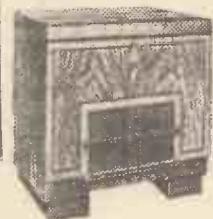

485A AC. All-World Superhet Autoradiogram. 6 valves. Five wave ranges: 7-16 (covers Television Sound Transmission), 16.7-53, 46-140, 185-560, 750-2200 metres. 38 gns.

ALL-WORLD RECEIVERS FROM 9½ GNS.



494 AC. All-World Superhet. 6 valves. Three wave ranges: 16.5-52, 195-580, 725-2000 metres. 12 gns.



491 AC. All-World Superhet. 6 valves. Three wave ranges: 16.5-52, 195-575, 725-2000 metres. 13½ gns.



482 AC. All-World Superhet. 7 valves. Three wave ranges: 16.5-51.5, 200-580, 725-2000 metres. Fluid Light tuning. 16 gns.

★ All models have two-speed tuning knobs and automatic volume control to counteract fading of distant stations. Radiograms have electric motors and automatic starting and stopping devices. Autoradiograms play eight records, 10" or 12", at one loading.



481 AC. All-World Superhet. 6 valves. Five wave ranges: 7-16 (covers Television Sound Transmission), 16.7-53, 46-140, 185-560, 750-2200 metres. 18½ gns.

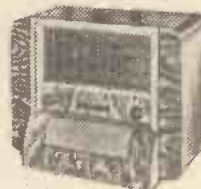

486 AC/DC. All-World Superhet. 5 valves. Three wave ranges: 16-50, 198-580, 750-2000 metres. 13½ gns.



801 AC. All-World High-Fidelity Concert Autoradiogram. 10 valves. Five wave ranges: 7-16 (covers Television Sound Transmission), 16.7-53, 46-140, 185-560, 750-2200 metres. Incorporates 24-hour electric clock and short-wave guide, cupboards for records (5 albums provided). 80 GNS.



581 AC. All-World Bureau Autoradiogram, similar to model 485A but has writing bureau cabinet with shelf for notepaper, cupboards for records (6 albums provided), interior lamp, combined short-wave guide, map of the world and blotter. 48 GNS.



487 AC/DC. Universal All-World Superhet Radiogram. 5 valves. Three wave ranges: 16-50, 198-580, 750-2000 metres. 25 gns.



492 AC. All-World Superhet Radiogram. 6 valves. Three wave ranges: 16.5-52, 195-575, 725-2000 metres. 25 gns.



493 AC/DC. Universal All-World Autoradiogram. 5 valves. Three wave ranges: 16-50, 198-580, 750-2000 metres. 33 gns.

BATTERY RECEIVERS



166. All-World Battery Superhet. 4 valves. Three wave ranges: 18-50, 195-580, 840-2000 metres. 13 gns.

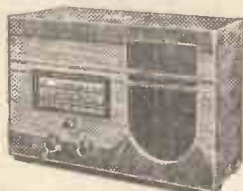

149. All-World Battery Receiver. 3 valves. Three wave ranges: 18-50, 195-560, 785-2000 metres. 9½ gns.

FILL IN THIS COUPON FOR FREE 24 PAGE CORONATION YEAR CATALOGUE

To "His Master's Voice," 108, Clerkenwell Road, London, E.C.1

Please send me a copy of your Coronation Year Catalogue giving details of the "His Master's Voice" All-World radio receivers and radiograms.

NAME.....

ADDRESS.....

THIRTY-NINE YEARS "SOUND" EXPERIENCE

Mention of "The Wireless World," when writing to advertisers, will ensure prompt attention.

The Wireless World

THE PRACTICAL RADIO JOURNAL
27th Year of Publication

No. 922.

FRIDAY, APRIL 30TH, 1937.

VOL. XL. No. 18.

Proprietors : ILIFFE & SONS LTD.

Editor :
HUGH S. POCOCK.

Editorial,
Advertising and Publishing Offices :
DORSET HOUSE, STAMFORD STREET,
LONDON, S.E.1.

Telephone: Waterloo 3333 (50 lines).
Telegrams: "Ethaworld, Sedist, London."

COVENTRY: Hertford Street.

Telegrams: "Autocar, Coventry."
Telephone: 5210 Coventry.

BIRMINGHAM:

Guildhall Buildings, Navigation Street, 2.
Telegrams: "Autopress, Birmingham."
Telephone: 2971 Midland (4 lines).

MANCHESTER: 260, Deansgate, 3.

Telegrams: "Iliffe, Manchester."
Telephone: Blackfriars 4412 (4 lines).

GLASGOW: 26B, Renfield Street, C.2.

Telegrams: "Iliffe, Glasgow." Telephone: Central 4857.

PUBLISHED WEEKLY. ENTERED AS SECOND
CLASS MATTER AT NEW YORK, N.Y.

Subscription Rates:

Home, £1 rs. 8d.; Canada, £1 rs. 8d.; other
countries, £1 3s. 10d. per annum.

*As many of the circuits and apparatus described in these
pages are covered by patents, readers are advised, before
making use of them, to satisfy themselves that they would
not be infringing patents.*

CONTENTS

	Page
Editorial Comment	413
New Band Pass Circuit	414
Phase Reversal	416
Unbiased	418
Further Notes on the Short-Wave Converter	419
Current Topics	420
The Television Receiver VIII	421
On the Short Waves	422
Broadcast Brevities	423
Practical Push-Pull Points	424
New Apparatus Reviewed	427
Listeners' Guide for the Week	428
"Distortionless" Driver	430
Marconiphone Model 222 Battery Superhet	432
Random Radiations	434
Recent Inventions	436

EDITORIAL COMMENT

Television

Make Haste Slowly

THE establishment of a co-axial cable between London and Birmingham, to which we referred in last week's issue, has already resulted in talk about the next television transmitter, and we find that Birmingham is looking forward to an early move on the part of the B.B.C. to put up a transmitter in that city, whilst other localities expect to be similarly served in the near future.

We have ourselves said that the co-axial cable to Birmingham paves the way for more stations. We would not, however, like it to be thought that *The Wireless World* regards it as expedient that additional stations should be put up at this juncture. Whilst not desiring to curb the progress of television in any way, we would urge that the B.B.C., as well as radio manufacturers, should move very warily as yet in the matter of extending the number of stations beyond the present one at Alexandra Palace.

The Palace station is doing excellent pioneering work; success has attended the efforts and a large number of television receivers have been purchased by the public in the London area, but up to date we do not consider that the public response to the television service in the London area has been sufficient to create extreme optimism regarding the potential success of other stations in different parts of the country.

Before a second station is contemplated, we think it imperative that the success of television in London should have been established beyond all possible doubt, and, further, that the maintenance of suitable programme material at a reasonable cost to the B.B.C., as well as an assurance that the sale of receivers provides a reasonable profit to the manufacturers, should

both be established before further ventures are embarked upon.

Only if television is a complete success in the London area can we expect that it will be reasonably successful in other centres, for in the Metropolis facilities for the programme side are freely available, whilst the average wealth of the population is higher than elsewhere, thus ensuring a better prospect for the sale of expensive sets.

The Coronation

P.A. Along the Route

BY the date of the Coronation it is expected that loud speakers for public address purposes will have been installed along the entire route of the procession. The main object will be to reproduce for the benefit of those lining the procession route the ceremony within the Abbey. In addition, it is understood, B.B.C. commentaries from different points will be reproduced as they will be broadcast. Arrangements have been made, we are told, for these commentaries to be faded out at those points where the procession is actually passing, so that at any section of the route the loud speakers will be silent so long as the procession is in view.

We do not think that this procedure has been adopted on any previous occasion of a public procession, and we venture to suggest the advisability of a rehearsal of this arrangement before the date.

The sound from loud speakers along the route will be capable of carrying for very great distances. The grandeur of the occasion would be sadly marred if during any interval in the processional music a noisy commentary were audible issuing from loud speakers farther down the route. The risk of such an occurrence should be most carefully guarded against.

OBTAINING FLAT - TOPPED RESONANCE CURVES

New Band-Pass

IF a modulated carrier is to be received without distortion it is necessary for the tuned circuits to have a characteristic which embraces both sidebands. Ordinary resonant circuits show maximum response at one frequency only, with the result that when the selectivity is high the upper modulation frequencies are seriously attenuated.

The use of a band-pass filter enables this effect to be overcome, for in its ideal form the response curve exhibits a flat top over the wanted range of frequencies, and has steeply sloping sides so that all frequencies which differ from the carrier by appreciably more than the highest modulation frequency are greatly attenuated. Such filters can be built but they are, in general, practicable only at low carrier frequencies; consequently, they are usually possible only in a superheterodyne having an intermediate frequency

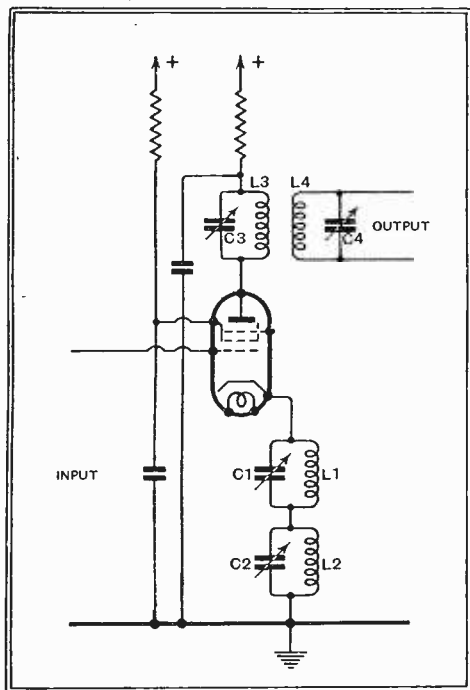

Fig. 1.—Conventional types of IF transformer are used, but the tuned circuits L1 C1 and L2 C2 are included in the cathode lead of the valve.

below 100 kc/s. The reason why true band-pass filters are impracticable at higher frequencies is that it becomes impossible to build components which have the values dictated by theory. For operation at 465 kc/s, for instance, it might

easily happen that a coil of several thousand microhenrys would be needed in a position where a shunt capacity of more than one or two micromicrofarads would be intolerable. Such a coil is out of the question since the self-capacity alone would be 10 $\mu\mu\text{F}$ or more.

Because of this the circuits which are generally used are coupled resonant circuits, and they are often known as band-pass filters although they are not truly of this type. Two circuits are usually em-

reducing selectivity, increases it, has been developed by Marconi's Wireless Telegraph Co., Ltd., and it makes use of the principle of negative feed-back. The circuit is shown in Fig. 1, and it will be seen to differ from the usual only by the inclusion of the circuits L1 C1 and L2 C2 in the cathode lead.

An IF transformer is included in the anode circuit and the circuits L3 C3 and L4 C4, which are individually tuned to the intermediate frequency, are coupled sufficiently tightly for a double-humped resonance curve, such as curve A of Fig. 2, to be produced. The cathode circuits are not tuned to the intermediate frequency; one is tuned to a slightly higher frequency and the other to a lower. Thus L1 C1 might be tuned to 475 kc/s and L2 C2 to 455 kc/s when the circuits L3 C3 and L4 C4 are tuned to the intermediate frequency of 465 kc/s.

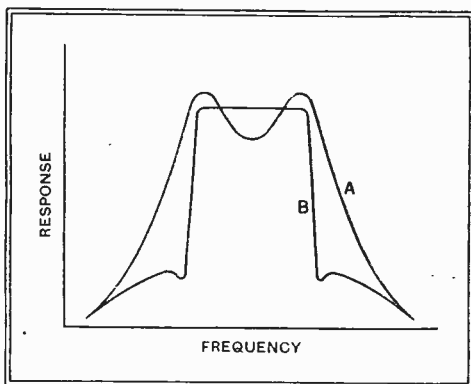

Fig. 2.—Curve A shows the response of an overcoupled pair of circuits, while curve B illustrates the improvement effected by the use of cathode circuits.

The Cathode Tuned Circuits

Now two parallel-resonant circuits connected in series have an impedance characteristic like that of Fig. 3. At the resonance frequency of each circuit the impedance is very high, being little different from the dynamic resistance of the circuit. At a frequency between these two frequencies of parallel resonance, however, series resonance occurs between the inductive reactance of one circuit and the capacitive reactance of the other and at this frequency the impedance is very low, being only the RF resistance of the circuit.

When the coupling exceeds the critical value the curve shows two peaks with a trough between them and this is again an unsuitable characteristic for it tends to accentuate the higher modulation frequencies. Many attempts have been made to combine such circuits with others having a single peaked response so that the peak of the one would fill up the trough of the other and give a combined response curve having a flat top.

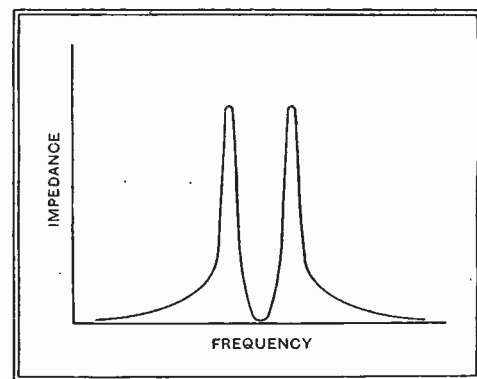

Fig. 3.—The impedance of the cathode circuits varies in the manner shown by this curve.

Variable Selectivity

Some of these attempts have proved successful and it can be shown that the best result is obtained when each coupled pair of circuits has associated with it a single circuit of one-half the Q ($= \omega L/R$). Unfortunately, the necessity for using some circuits of low Q reduces the selectivity, and to obtain normal selectivity a greater number of tuned circuits must be employed than in a less scientifically designed amplifier. The band-pass characteristics will be much better, however.

A new method of obtaining a flat-topped resonance curve which, so far from

Because these circuits are in the cathode lead of the valve they are common to both grid and anode circuits and negative feed-back occurs just as it does in an AF stage in which the bias resistance by-pass condenser is omitted. The amount of feed-back depends on the impedance of the cathode circuit and as the impedance varies with frequency the feed-back varies

Circuit

ONE of the greatest problems in modern reception is the attainment of selectivity and quality together. The true band-pass filter theoretically offers a solution but is usually impracticable for broadcast receivers. A new circuit is described in this article, however, which enables exceptionally good band-pass characteristics to be secured, the good performance being obtained by means of negative feed-back.

also. At the intermediate frequency the impedance is very low so that there is little feed-back and the amplification is nearly equal to the normal stage gain. As the impedance rises the feed-back increases and the amplification falls until it reaches a minimum at the two frequencies of maximum cathode circuit impedance.

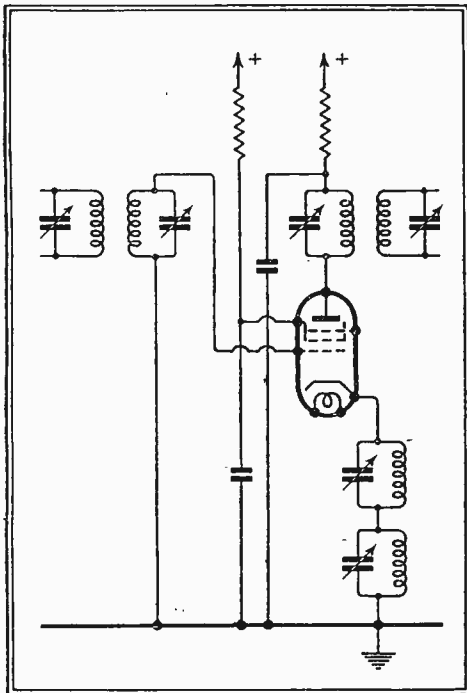

Fig. 4.—A complete amplifier is shown here and it will be seen that the cathode circuits can correct for two IF transformers.

The net result is to transform the curve A of Fig. 2 into a characteristic similar to that of curve B. The circuit causes some loss of amplification, but not a great deal; it makes the top of the resonance curve almost completely flat, and the sides slope so steeply that the selectivity is actually increased by its use. In practice, the pair of cathode coils can correct for two over-coupled IF transformers and the arrangement of Fig. 4 would normally be adopted. This arrangement is particularly well adapted to variable selectivity for it is only necessary to use variable-selectivity types of IF transformer to achieve this in an almost ideal manner. Both transformers should have variable coupling between the coils and the controls should be mechanically linked in the usual way.

When the cathode circuits are correctly adjusted for a flat-top at maximum bandwidth, the curve remains flat-topped as the coupling in the IF transformers is loosened, but the width of the top decreases and the selectivity naturally rises. When the coupling becomes loose, the flat top to the resonance curve becomes rounded and extremely high selectivity is obtained. These characteristics are well brought out by the curves of Fig. 5 which show the performance at several different settings of the selectivity control and, for comparison, the results with the two IF transformers alone.

The design of the system is naturally somewhat complex, for the constants of all tuned circuits and of the valve are inter-related. For the guidance of the experimenter, however, it may be said that when IF transformers of ordinary commercial efficiency are used with a valve having a mutual conductance of about 2.0 mA/v. the cathode circuits should have a Q of about 50 with a dynamic resistance of some 10,000 ohms. This means coils of about 70 μ H for a frequency of 465 kc/s, so that the condensers should be about 0.0017 μ F. The condensers must, of course, be adjustable.

Aligning the Circuit

Cathode-ray gear is really desirable when setting up a system of this nature, for it is very difficult to find out just what is happening without it. It is, however, possible to align the circuits with nothing more than a test oscillator and output meter, and the correct procedure is then as follows: Short-circuit the cathode coils and set the selectivity control for maximum selectivity. Connect up the test oscillator, and set it to the desired intermediate frequency, say, 465 kc/s, and adjust each IF transformer trimmer for maximum output. Then set the variable selectivity control to minimum, swing the oscillator through the band and check that the two humps are of approximately equal height and that the trough is midway between them. Adjust the coupling to the point at which the peaks are about 30 kc/s apart.

Remove the cathode short-circuit and set the oscillator to a frequency 30 kc/s higher than the intermediate frequency (495 kc/s) and then adjust the trimmer

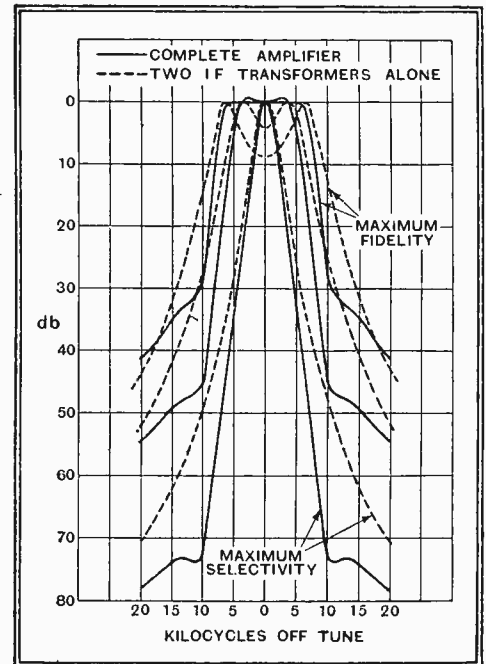

Fig. 5.—These curves illustrate the actual performance of an amplifier similar to that of Fig. 4 and embodying high-Q coils.

on one cathode circuit for *minimum* output. Set the oscillator to a frequency 30 kc/s lower than the intermediate frequency (435 kc/s), and adjust the other cathode circuit trimmer for minimum output. Then swing the oscillator through the band and check that the resonance curve is of the form shown in Fig. 5. This procedure will only give correct results if carefully carried out and if the circuit constants are correct. It is possible to obtain a flat-topped curve, however, even when there are discrepancies in circuit values by mistuning one of the cathode circuits slightly, but the selectivity on one side of resonance will then be somewhat lower than on the other. If the check shows that the curve is not flat-topped, therefore, an endeavour should be made to correct it by adjusting one of the cathode trimmers.

It should be emphasised that thorough screening and decoupling must be adopted and the amount required naturally increases with the efficiency of the circuits; it is hopeless to expect satisfactory results if there is a tendency to instability. Capacity couplings between primary and secondary in the IF transformers must also be reduced to a minimum if a symmetrical resonance curve is to be obtained.

WIRELESS ENGINEER.

Contents of the May Issue.

"Superheterodyne Padding Capacities," by W. T. Cocking, deals with the tolerances permissible to maintain satisfactory ganging. A diode voltmeter for the measurement of very high frequencies is described by Manfred von Ardenne. A method of measuring the self-capacity of iron-cored coils is explained by M. Reed, M.Sc., and there is an interesting article by a member of the Oxford University Arctic Expedition on radio communication in the Far North.

The issue also contains the usual monthly abstracts of the world's radio papers

Phase Reversal

By C. C. INGLIS

THE author describes a novel method of introducing phase reversal in push-pull amplifiers; an ordinary heptode valve is used, with appropriate load resistances in its anode and screen circuits.

A NEW METHOD OF FEEDING PUSH-PULL AMPLIFIERS

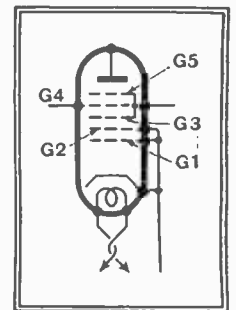

Fig. 3.—Illustrating the action of the various electrodes.

ONE of the most satisfactory methods of phase reversal for push-pull amplifiers is that incorporated in the various *Wireless World* Quality Amplifiers, and shown in Fig. 1. But in the experience of the writer it seems that, if cathode-heater insulation is not of a high order, hum can result. If there is a small leakage between the heater and the cathode AC potentials are bound to develop at the cathode, whence they are passed on farther into the amplifier. In addition, this method, while successful in many cases, does not line up with the symmetry associated with push-pull working. Steps were therefore taken to devise some scheme which would overcome these difficulties.

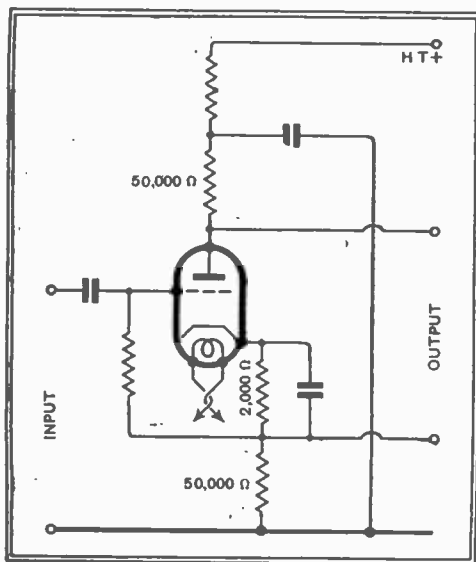

Fig. 1.—The system of phase reversal used in the Quality Amplifier.

It is clear that if a valve can be produced in which the change of a control grid voltage produces a rise of current in one electrode and a fall in another, and if suitable load resistances are introduced in these circuits, then the required effect is produced, and it has been found that this effect occurs in frequency-changer valves of the heptode type such as the MX40, etc. Fig. 2 shows characteristic curves of such a valve. The actual valve from which the curves were obtained was a Triotron 2A7.

It will be seen that the screen current falls when the grid bias is decreased and the anode current simultaneously rises, and vice versa, so that load resistances in these circuits, as shown in Fig. 2a, will produce voltages at the anode and screen respectively in phase opposition. In

taking all curves and throughout the series of experiments which were made, the oscillator anode and grid were strapped to the cathode, and are of no value for the present purpose of the valve.

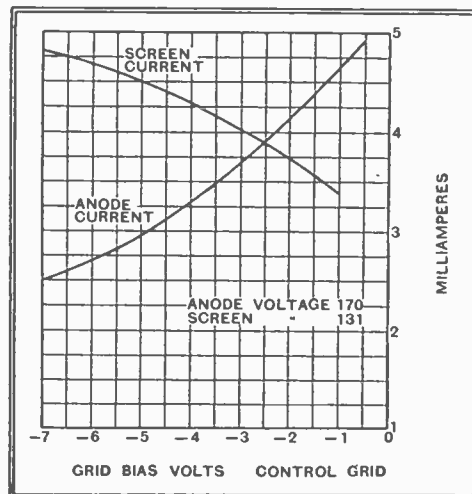
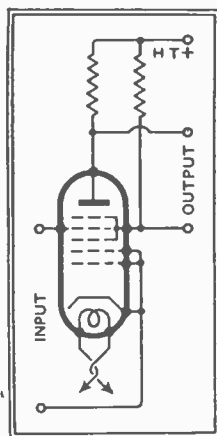

Fig. 2.—Explaining how the properties of the heptode valve are used for phase reversal.

In explaining the reason for these effects it is assumed that the screens G3 and G5 (Fig. 3) collect some of the electrons in their passage from the cathode to the anode, the anode serving as the final collector.



Now, G4 is at a negative potential with respect to G3, and, therefore, has a retarding effect on the flow of the electrons due to the negative field round it. Increase in this negative field will deflect or, rather, force more electrons to be col-

Fig. 2a.—Connections of a heptode valve for phase reversing.

lected by G3, with resulting increase in current.

The action of G5 is not clear, and it could not be investigated, as the electrode is strapped internally to G3. The ultimate effect, however, is that the sum of the currents in G3 and G5 rises with increasing negative bias on G4. The anode current falls under these conditions due to the normal effect.

It may well be asked why an ordinary screen-grid valve was not tried. The reason is that to produce the effect required the screen would have to be used as the control grid, and the grid usually used for this purpose would have to have a positive bias of about 100 V., and it was doubted whether it would stand this owing to its closeness to the cathode. In a heptode valve the three outer grids are well spaced from the cathode, due to the presence of the oscillator anode and grid between them and the cathode.

In order to find out what would happen under working conditions, and to decide what values of load resistances would be most suitable, further curves were taken of the anode and screen currents plotted against grid voltages, but with load resistances included, and three of these are shown in Figs. 4, 4a, and 4b. The values of the voltages and resistances are shown, and it can be assumed that these curves are dynamic and not static. It will be seen that for the particular values of load resist-

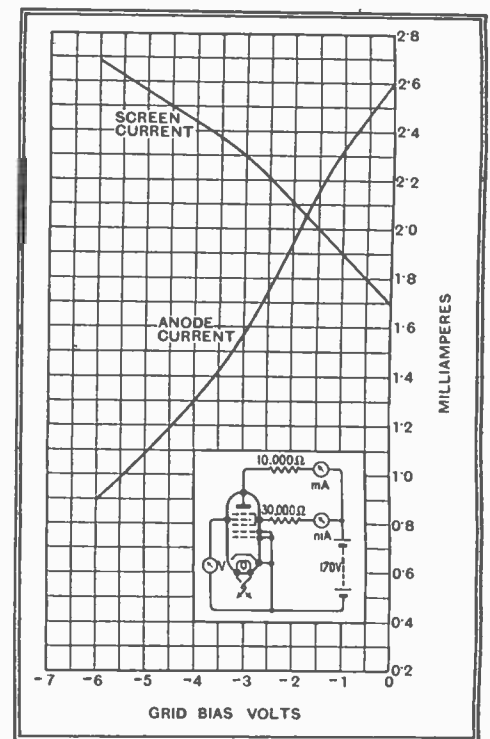

Fig. 4.—To obtain the desired working characteristics, various values of anode and screen resistances were tried.

Phase Reversal—

ance shown in Fig. 4 a change in grid volts between 3 and 2 produced a change of 4 mA. in the anode circuit, resulting in a change of 4 volts giving an amplification of 4. The screen circuit, however, produced a change of 2 mA. resulting in a change of voltage in the screen circuit of 6 volts. The output voltages will, therefore, be these and the screen load would

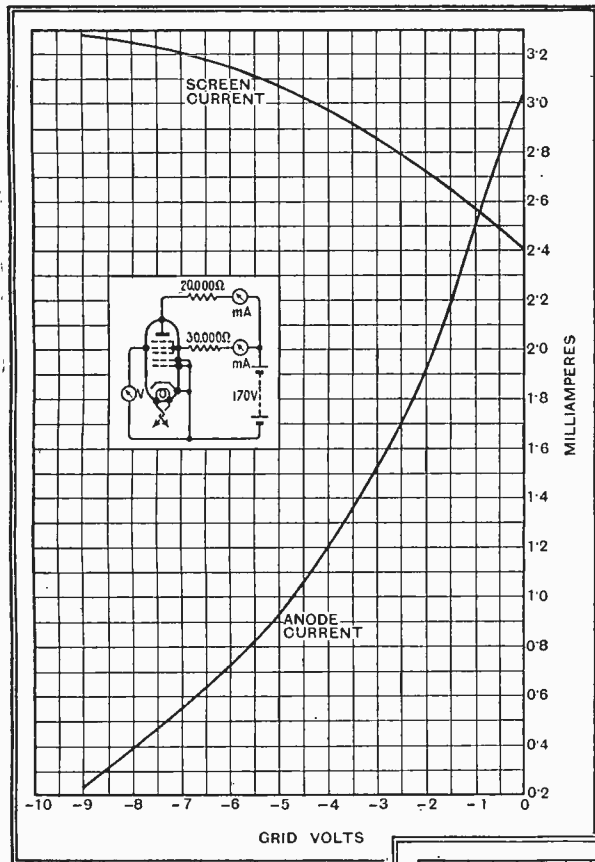

Fig. 4a.—The effect of increasing the screen load resistance.

have to be tapped down to produce equal AC voltages at anode and screen.

The final arrangement as used by the writer for his Quality Amplifier is that shown in Fig. 4b and dynamic curves are shown also.

A point of criticism arises in the fact that these dynamic graphs are not straight, as they should be for distortionless working. A reason for this is that the control grid has a multiple characteristic, and a valve in which the control grid has a fixed characteristic would

Fig. 4b.—Characteristics of the arrangement finally used in the author's amplifier.

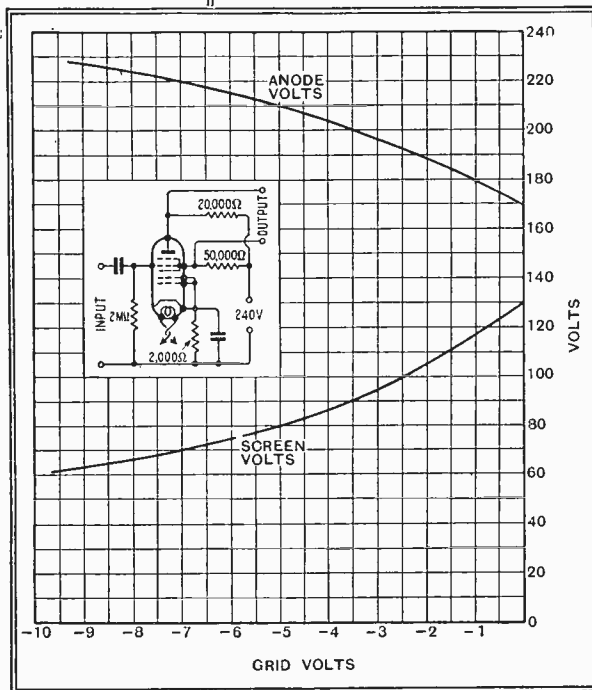

enable higher input voltages to be handled. A further reason may be that secondary emission may play a part in determining the actual shape of the curves.

In order, therefore, to determine the maximum output voltage of the arrange-

ment (Fig. 4b) without distortion due to the curvature of the characteristics, an AC voltage at 50 cycles which could be varied between limits was applied to the control grid at a mean voltage of -8 and was gradually increased to such value that, on switching on and off, a change in value of anode and screen current could be detected. The change consisted in a rise of anode current and a fall in screen current.

When this happened, rectification was taking place and occurred at a value of 2 volts AC applied to the grid. The output volts obtained from this are of the order of 8/10 volts, which is ample to supply the *Wireless World* Quality Amplifier. The maximum input voltage of the Quality Amplifier must be 3 or 4 volts so that this phase reversal valve is working well within its capacity.

The grid bias is 8 V, and at this point there was very little difference in the amplification factor of the screen and anode circuits, so that the output voltages were substantially the same and potentiometers in these circuits were unnecessary in order to preserve balance.

It will also be noticed that the ordinates show the anode and screen voltages and the abscissæ the grid voltage. These curves are obtained from the milliamp. readings by multiplying the currents of the anode and screen by their respective load resistances

and subtracting these amounts from the supply voltage. It will be appreciated that accurate results are impossible by direct measurement of the anode and screen voltages, due to the load of the voltmeter, and electrostatic voltmeters were not available.

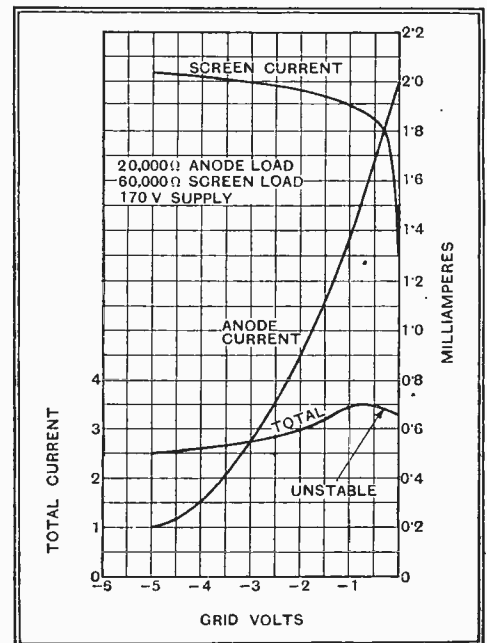

Fig. 5.—Under certain operating conditions a negative resistance effect, resulting in instability, will occur.

The scheme has been tried with an amplifier and works with considerable success and a complete absence of hum. In addition, extra amplification is obtained.

It is interesting to note that with a reasonable change in grid voltage the change in the supply current to the anode and screen together varies very little, so that anode decoupling need not be very complete. Similarly the cathode biasing resistance theoretically need have no bypass condensers but these have been added for safety's sake.

During the experiments one interesting point was noticed: if for a change in control grid voltage the change in screen current is more than that of the anode current, then the system will be unstable, and will have in it a negative resistance effect. This effect has been obtained with the 2A7 valve, and is shown in Fig. 5; it will only take effect if automatic biasing is used at low values of control grid bias and with unusual values of anode and screen voltages.

The writer would be interested to hear from anyone who tries this method with other makes of frequency-change valves or any valve with the necessary electrodes.

One word of warning should, however, be offered: valve manufacturers are in general adverse to the use of series resistances in screen circuits, due to the difficulty of producing consistent characteristics, also the variation in tail characteristics of the anode circuit makes it quite possible that with a similar valve to that used by the writer different values of load resistances would be found more suitable. Those interested, therefore, would be well advised to make their own series of experiments to determine the best values of loads and voltages. Experimenters will also find that the success of the system rather depends upon the adjustment of cathode temperature, and it is advisable to provide some means to adjust this.

UNBIASED

By Free Grid

Some Startling Revelations

IT is astonishing what a lot you can learn about the petty fads and foibles of the eminent if you only get to know the right people. It has been said—by Julius Cæsar in one of his letters home from the Flanders trenches, if I recollect rightly—that one half of the world doesn't know how the other half lives, and I am constantly proving for myself how very true this observation is. Had I not once made the acquaintance of one of the down-trodden slaves in Portland Place, for instance, I should never have learnt that a certain eminent personage—I simply dare not mention his name—has a kipper with his tea every day at Broadcasting House.

My accommodating acquaintance who gave me this startling information used to chat over the 'phone with me, but now that we have learnt about the tapping of telephone conversations, we simply dare not run any risk, and are therefore compelled to meet in a secret milk bar about a couple of wavelengths distant from Broadcasting House for a quiet chat over a glass of milk-and-it. Even now I do not know if we are quite safe, as I have long suspected the peroxidised milkmaid, who usually serves us, of being a secret agent of the corporation, if indeed she is not one of the very eminent ones himself in disguise. I rather suspect the latter, for although the disguise is well nigh perfect,



A glass of milk-and-it

her false teeth show that peculiar form of wear that is caused by the habitual grinding of a pipe stem.

However, I digress. What I intended to say was that it is in this *rendezvous* that I have learned some very astonishing things, not only about the goings on at Broadcasting House, but elsewhere also,

and curiously enough the most astonishing of them all does not concern the B.B.C. at all, but has to do with the meteorological experts who provide the corporation with its daily weather forecasts.

Now as most of you know, these are prepared by a committee of highbrows who base their prophecies—or at least, I used to think so—on reports sent in from observers here, there and everywhere, concerning the prevalence, in their particular area, of various things such as millibars, a word which old listeners will recollect was much beloved by the B.B.C. until some purity league or other protested against it on moral grounds, although the precise nature of the grounds escapes me for the moment. However, it is not a particularly important point, and doubtless the more sophisticated among you will know what I mean.

Although it is still true, of course, that these highly scientific reports arrive daily at the meteorological office, the weather forecasting experts have, according to my informant, long since given up making any real use of them. It appears that there used to be a committee to discuss these reports, but like all scientists, each member of it had his own pet interpretation of them, and this accounted for the highly ambiguous phrases in which the forecasts used to be couched, and also for their lack of accuracy.

It appears that the chairman of this committee of experts got so fed up with the whole business of adjudicating in the wrangles of his subordinates that when they went on their annual treat to Blackpool, he made a point of bringing back with him a quantity of seaweed from that delightful resort, and nowadays he invariably ignores the millibar reports of the observers and the wrangles of his expert committee, and draws up the forecast himself after duly feeling his seaweed, and this, I am told, accounts for the much greater percentage of accuracy which has attended them of late years.

Indelicate Programmes

ALTHOUGH I have always been a keen scientific experimenter right from my childhood days, when I fitted my pram with auxiliary propulsion gear to assist the nursemaid on the somewhat steep slopes of my native town, I have always had a horror of fooling about with the insides of the human body in any shape or form. Somehow or other it has always seemed to me such a messy pastime and it is for this reason that I always resent the strong

medical flavour associated with the sponsored programmes with which certain Continental stations inundate us on Sundays.

I cordially dislike the embarrassment of being compelled to listen to indelicate discussions concerning the undulations of my uvula and other intimate physiological details, more especially when ladies are present, although, alas! with the so-called broad-mindedness of this modern generation, my embarrassment is seldom reciprocated.

Unfortunately there is very little else available for the average monoglot British listener, and he is between Scylla and Charybdis in the shape of the B.B.C.'s Sabbath efforts and the medical lewdness with which certain Anglo-Continental stations intersperse the ululations of their crooners. I am delighted to see, therefore,

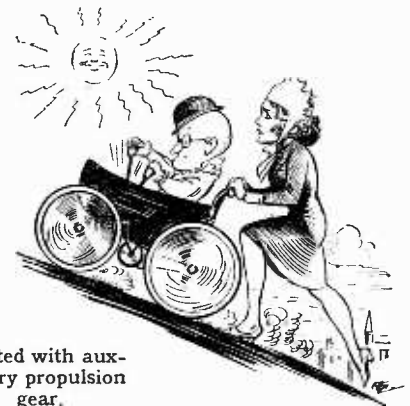

Fitted with auxiliary propulsion gear.

that one of the aforementioned monoglot listeners has proved once more the old proverb about necessity being the mother of invention by producing an automatic record-changer of a very unusual type in order to get over the difficulty.

Solace on the Sabbath

The unusual point about the apparatus is that it is not intended for use in connection with the reproduction of records but for the recording of them. Actually, it is a very simple adaptation of one of the many instruments on the market which change eight records at a time. The inventor, in a letter which he has sent to me asking me to give publicity to his efforts, tells me that he has never been able to listen to the B.B.C.'s praiseworthy Saturday night efforts as they have always clashed with a standing engagement at his darts club which holds its weekly championship contests at the local pub on Saturday evenings.

The result has been the production of this remarkable device, and nowadays the inventor merely sets his adapted record-changing apparatus into operation before leaving the house on Saturday evening and so has the B.B.C. Saturday night programme bottled up ready to serve up to the family on Sunday afternoons thus saving them from B.B.C. boredom on the one hand and Continental indelicacy on the other.

Further Notes on the Short-Wave Converter

By

H. B. DENT



AC Short-Wave Converter arranged for use with the Experimenter's IF amplifier.

MODIFICATIONS FOR ITS USE WITH THE EXPERIMENTER'S IF AMPLIFIER

DURING the early stages in the design of the AC Short-Wave Converter consideration was given to the likelihood of it being used with the Experimenter's IF Amplifier which was described in *The Wireless World* of January 29th last. This was one of the reasons why 550 kc/s was chosen for the intermediate frequency as it is the nearest approach to 465 kc/s possible with an average broadcast set.

By using this particular IF it would require only a few alterations to make the converter operate satisfactorily with the amplifier in question. Actually fewer changes are needed than was at first expected for it has transpired that only on range 3 is it necessary to make any modifications to the coils. This is, of course, in addition to omitting the special IF transformer on the converter as the input transformer on the Experimenter's Amplifier takes its place.

Best Position

If the two units were placed side by side with the converter on the left, which seems the natural position for it, the trimming condensers in the short-wave unit will be obscured by the amplifier, and furthermore a longer lead than is actually desirable would be required to join the anode of the frequency-changer to the first IF transformer.

It would be better to locate the short-wave unit on the right, which shortens the connections, though it will entail a minor alteration to the input lead on the amplifier.

It is suggested that in place of the screened lead used in the original model of the Experimenter's Amplifier a Belling-Lee screened socket connector be fitted on the right-hand side of the chassis. A short screened lead can then be connected to the anode of the frequency-changer and by fitting the companion plug part of the Belling-Lee connector to it a

convenient inter-unit connection is made.

The HT and LT voltages for the converter can be taken from the power pack supplying the IF amplifier, but it should be remembered that the centre tap on the four-volt winding supplying filament current must be disconnected from the power-pack chassis. This is essential, as in the converter one side of the heater wiring is joined direct to the earth line.

Now, with regard to the modifications to range 3 of the converter. All that this entails is the rewinding of the oscillator coil L₉, which requires one extra turn, making 26½ in all, but using, of course, the same gauge of wire.

There is no need to make any changes in the winding of the other coils or in the values of the series-tracking condensers as they hold good for the lower intermediate frequency.

Oscillator Voltage

One other change is advised, though it is not absolutely essential. The converter's own power unit supplies about 300 volts HT, since it is operating with a comparatively light current load, but when the HT is taken from the power pack of the Experimenter's Amplifier, which with the heavier load is delivering 250 volts, the frequency changer screen and oscillator anode voltages suffer a proportionate reduction. This is of little consequence in the case of the former, but in order to restore the latter to its original value the resistance R7 should be changed for one of 50,000 ohms.

Comparisons made between the two alternative arrangements, viz., broadcast set and Experimenter's Amplifier, show that in general the latter gives the better performance. Not only is the IF gain greater than in an ordinary broadcast set, but it is possible to arrange for a more efficient coupling to the short-wave unit.

The Radio Industry

MANY business organisations are placing large advance orders for copies of the official Coronation programme for distribution among their staffs and customers. As is well known, the programme is issued by King George's Jubilee Trust (St. James's Palace, London, S.W.), to which the whole of the profits will be devoted. It is hoped that the radio industry generally will help this excellent cause by following suit.

By the addition of a valve rectifier and smoothing equipment, the Ridco "Ranger" Short-Wave Unit has now been made suitable for either A.C. or D.C. mains. The makers are Radio Industries Development Co., Birch Street, Hanley, Stoke-on-Trent.

Large export shipments of the new Ekco models would indicate the intense interest of overseas listeners in the Coronation broadcasts.

A series of "Coronation" IIT batteries, in red, white and blue cartons, has been introduced by Pertrix.

Mr. S. R. Burbridge, appearing in the television "Picture Page" feature on April 21st, described his experiments in receiving television programmes from Alexandra Palace at Brighton, a distance of over 50 miles. Mr. Burbridge uses a G.E.C. receiver.

Current Topics

Events of the Week in Brief Review

Wireless Transmitting Contest

A CONTEST under the auspices of the Radio Society of Northern Ireland, open to all licensed transmitters in the world, is to be held from midnight on each of the Fridays in May to midnight on the corresponding Sundays. At the end of the contest the leading Irish transmitter will be awarded the Leonard Trophy for one year, a gold medal being presented to the leading non-Irish station. Full details may be obtained by writing to the Secretary of the R.S.N.I., Mr. F. A. Robb, 46, Victoria Avenue, Sydenham, Belfast, Northern Ireland.

Indian Broadcasting

THE Madras Government is proposing to install 100 communal receiving sets in villages all over the Presidency. The Government will also erect short-wave broadcasting stations near Saidapet and a medium-wave station at Trichinopoly.

The Bombay Government has already installed eighteen receiving sets in nine villages under its jurisdiction. They have been fitted in public buildings such as schools, and are fully automatic, being provided with a time-switch. A special motor truck has been equipped for servicing, and visits the villages at regular intervals.

The Theatre and Broadcasting

AN international theatrical conference to be held in Prague from May 8th to the 17th is to make a thorough examination of the relationship between the theatre and broadcasting. An effort is to be made to put it on a more satisfactory basis.

New Wireless Stamp

THE Austrian postal authorities have just produced a new stamp bearing the features of the inventor, Von Lieben, together with the first wireless valve which he made.

Piracy in Germany

DURING the past three months 144 German listeners have been convicted of using wireless sets without a licence. Fines ranging from 3 to 100 marks have been inflicted.

Discontent in France

GREAT dissatisfaction is being expressed in the French Press with the ever-increasing educational tendencies of the wireless programmes. In addition, complaints are made of too much inter-station relaying of programmes and of "diagonalising" after the manner of the B.B.C.

The Tell-tale Microphone

IN certain schools in America, and also in Russia, classrooms have been equipped with microphones connected via suitable amplifiers to the headmaster's study. By means of a selector switch the headmaster is enabled to listen to the doings of any particular class without warning. A report of a somewhat similar arrangement in an English school appeared in certain newspapers two years ago.

American Valves for Denmark?

A STRONG move is being made to get the Danish Government to permit the importing of American valves on the ground that they cost about half the amount of equivalent European ones. No new American valves have appeared in Denmark since the special import regulations were imposed by the Danish Government in 1931.

Licence Figures

THE total number of wireless licences in force in Great Britain at the end of March was 8,127,747. French listeners are now rapidly approaching the four million mark, Japanese being a little short of three million.

Holiday with Pay

BRITISH Rola employees are to observe Coronation Week as a complete holiday. The works will close on the evening of May 11th and will reopen on the morning of May 19th. All workers will receive a full week's wages for the holiday period. For some time this firm has been working a forty-hour five-day week, pay being given for Saturdays, although no work is done on that day.

Ultima Thule

FOLLOWING the marooning of the film company taking part in the production of "The Edge of the World," on the island of Foula, a beam wireless station is to be established to link the island with the mainland.

"Suppressing" Malayan Cars

THE Government of the Federated Malay States has recently passed legislation compelling all motor cars to be fitted with devices to prevent the radiation of short-wave interference. Vauxhall Motors, which does an extensive export trade with Malaya, entrusted to Philco the task of finding means of making their cars comply with the new ordinance. Philco engineers have now devised a method which, it is stated, is simpler, more effective, and more fool-proof than the usual resistance system; the cost is only 1s. per car.

Broadcasting Censorship

BY a decree just issued in Italy, the powers of the Ministry of Press and Propaganda are increased to embrace all wireless and television broadcasting.

A Well-known Amateur

CAPTAIN ALEXANDER PATTERSON, the pilot of the ill-fated flying boat "Capricornus," was a very well-known amateur transmitter in Egypt, his call letters being SU1AP.

Australian SW Transmissions

DURING May, Sydney (VK2ME) may be heard on 9,590 kc/s (31.28 metres) from 0600 to 0800, 1000 to 1400, and 1530 to 1730 on Sundays only. Melbourne (VK3ME) will be working on 9,510 (31.5 metres) from 0900 to 1200 daily, except Sundays.

Polytechnic Television Lectures

A SPECIAL course of lectures on television is to be given at the Polytechnic from 7.30 p.m. to 9 p.m. on May 31st and the three subsequent Mondays. The lectures will be delivered by Mr. H. J. Barton Chapple. Full details can be obtained by writing to the head of the Telecommunications Section at the Polytechnic, Regent Street, W.1.

H.M.V. Television Autoradiogram Model 902

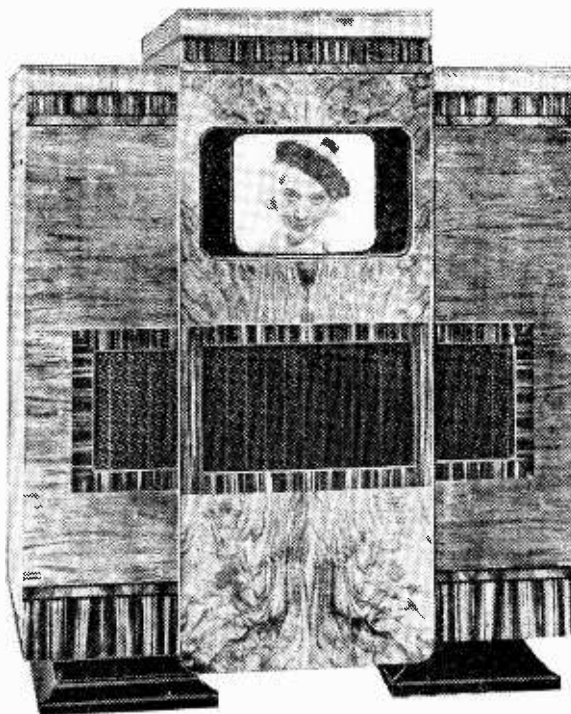

Three instruments in one, the new H.M.V. Model 902.

TO meet the demand for a television instrument which shall at the same time provide all the facilities of an up-to-date radiogramophone, a new receiver to be known as the Model 902 has been introduced by the Gramophone Company, Ltd.

There are virtually three distinct elements in this comprehensive instrument—the vision receiver, a multi-range receiver covering 16.7 to 2,200 metres in four wavebands with an additional range for the television sound accompaniment, and an automatic record-changer playing up to eight 10-in. or 12-in. records. The record-changer occupies a central position in the cabinet, and is raised above the level of the television and sound receiver controls, which occupy panels to the left and right respectively. A separate lid is provided for each unit.

The price of the Model 902 is 120 guineas, including a special television aerial, free installation and maintenance for one year.

The Television Receiver

VIII.—THE STRAIGHT SET

By W. T. COCKING

LET us now consider the design of a straight set just as we did in the case of a superheterodyne, for by comparing the two paper designs we shall be in a better position to judge their merits on a financial basis. We require a gain of 50,000 times; if we use six RF stages the stage gain must be $\sqrt[6]{50,000} = 6.06$, or about 6 times. With valves having a mutual conductance of 6.0 mA/V this means a dynamic resistance of 1,000 ohms for the tuned anode circuits. With the circuit capacity equal to 27.5 $\mu\mu\text{F}$., CR=27,500 and reference to Fig. 6 (Part III) shows that for a bandwidth of 4.0 Mc/s the response at the edges of the band is -1.7 db. With six RF valves there will be seven couplings, so that the overall response will be -11.9 db. and the response at 3.5 Mc/s off-tune will be -28.0 db.

We can probably improve the response in the pass-band and increase the rejection at the frequency of the sound channel by using somewhat more efficient circuits and staggering their resonance frequencies. Alternatively we can use pairs of coupled circuits for the couplings. It is unlikely, however, that we can obtain the necessary gain with fewer than six RF stages.

The Output Stage

We come up against one difficulty in the last RF stage, however. Owing to the higher frequency the detector as a whole is likely to be rather more efficient than that of a superheterodyne, but the difference will not be great and we shall still require a large output from the last RF valve. We have seen that it is necessary to use a valve such as the N43 in this stage if we are to obtain a detector output of 30 volts p-p, but this valve has a grid anode capacity of 0.3 $\mu\mu\text{F}$.. Although it is possible to use it at 10.0 Mc/s without instability, it will be over twice as difficult at 45.0 Mc/s. Indeed, the theoretical limit to the grid and anode circuit impedances is of the order of 1,500 ohms if stability is to be obtained in this stage alone. With all the earlier stages operative, these circuit impedances would certainly have to be reduced to maintain stability.

Unless we adopt neutralising, therefore, we are forced to abandon this type of valve as an RF amplifier. With an RF pentode in the last RF stage we cannot obtain sufficient output for a single detector. It would probably be possible to obtain adequate output by using a voltage-doubler detector, but this is open to the objections that there will be nothing to spare, that an extra valve will be needed, and that the gain obtained through this extra valve will only be 2.

It was pointed out in Part VII that the straight set offers considerable advantages over the superheterodyne in that it is not subject to certain types of interference and that it is easier to secure the optimum signal-noise ratio.

If we could use post-detector amplification all these difficulties would disappear. The case for and against VF amplification was presented in some detail in Part II, and it was shown that there were certain disadvantages, notably in connection with synchronising, which made us decide not to use it. For the moment let us ignore these disadvantages and see how the design of our receiver will progress if we use one stage. If the finished design appears much better than that of the receiver without such amplification, then it will be worth while to try to overcome its drawbacks.

Using a TSP₄ as a VF amplifier with the series resistance and coil type of coupling, the stray capacities are likely to total 35 $\mu\mu\text{F}$., including the input capacity of the CR tube. With the aid of Fig. 10 (Part IV) we can calculate the values and find that R=3,500 ohms, L=217 μH ., and A=21 for a drop in response to -2.0 db. at 2.0 Mc/s. Moreover, the valve characteristics show that an output of 30.0 volts p-p is easily obtainable with this load.

A stage gain of 21 is quite respectable, and assuming that the detector efficiency remains unaltered we shall require an RF gain of only 50,000/21=2,375 times. With five RF stages the gain per stage would be 4.74, with four stages 7.0, and with three stages 11.2 times. With g=6.0 mA/V, this means dynamic resistances for the tuned circuits of 795, 1,160, and 1,870 ohms respectively, giving CR products of 19,900, 29,000, and 46,000 when C=25 $\mu\mu\text{F}$.. From Fig. 6 we obtain the drop per circuit for a 4.0 Mc/s bandwidth and the figures are shown in the table.

Among the requirements laid down in Part I for our receiver were a response at 1.5 Mc/s of -6.0 db. and at 3.5 Mc/s off-tune of at least -30.0 db. The former is satisfied

by four RF stages, the latter very nearly by three. The fewer stages thus enable greater selectivity to be secured, but at the expense of the modulation frequency response, because, although the number of tuned circuits is less, each circuit is sharper. If design is carried out for the same degree of sideband cutting in each case, however, then the selectivity increases with the number of tuned circuits.

What are we to do in this case, since five circuits are not selective enough and yet four cut sidebands too much? One solution would be to adopt five circuits, each one of which is damped somewhat less so that the overall selectivity equals that of the four sharper circuits. The increase in gain could be offset by increasing the grid bias of the valves a little. We should then have a modulation frequency response lying between those of the three and four valve arrangements in the table. Alternatively, we can reduce the gain and broaden the resonance curve by staggering the tuning of the circuits and this is probably the better course.

How Many RF Valves?

The three-valve arrangement is very attractive, however, because it involves less material and is consequently cheaper. It gives the necessary gain and selectivity, but cuts sidebands more than we should like. Is there any chance of obtaining good results with it? The answer is "Yes." In the first place, the frequency requirements which we have laid down are rather arbitrary. The size of the spot on the CR tube places one limit to the response; if the spot is larger than one picture element, then there is no point in supplying the tube with the highest frequencies for the proper response cannot be secured. Furthermore, the falling-off in definition when the high frequencies are attenuated is small at first, just as in the case of sound reproduction quite large attenuation of frequencies around 10,000 c/s may have very little audible effect.

The second point is that we shall only obtain the response given in the table if

PERFORMANCE v. NUMBER OF STAGES.

No. of RF Valves	5	4	3
Gain per stage	4.74	7.0	11.2
R (ohms)	795	1,160	1,870
CR (C in $\mu\mu\text{F}$. = 25 $\mu\mu\text{F}$.)	19,900	29,000	46,700
DB drop per circuit 4 Mc/s band-width	- 0.95	- 1.85	- 3.87
DB drop per circuit at 3.5 Mc/s off tune	- 2.4	- 4.3	- 7.3
Overall DB drop 4 Mc/s band-width...	- 5.7	- 9.25	- 14.48
Overall DB drop at 3.5 Mc/s off tune	- 14.4	- 21.5	- 29.2
Overall drop in response at 2.0 Mc/s, including VF stage	- 7.7	- 11.25	- 16.48
DB drop per circuit 3 Mc/s band-width	- 0.55	- 1.12	- 2.45
Overall DB drop 3 Mc/s band-width...	- 3.3	- 3.6	- 9.8
Overall drop at 1.5, including VF stage	- 3.6	- 5.9	- 10.1

The Television Receiver—

all four circuits are tuned to resonance. We can broaden the resonance curve by staggering the resonance frequencies of two circuits. This will reduce the gain to some degree and also the selectivity. We have also the possibility of mistuning all the circuits a little towards the high-frequency side of the signal. This will leave the gain at about its normal figure, improve the rejection of the sound signal, and improve the modulation frequency response because, although the bandwidth will remain the same, we shall virtually be adopting single sideband working.

Incidentally, the full gain of the RF stages is not always needed. In fact, it is required only when the receiver is at a considerable distance from the transmitter. At shorter distances, therefore, it is good practice to reduce gain by mistuning circuits to some degree, and under these conditions the response in the pass-band can be made as good as desired.

It would thus appear that we can build a straight set which will give the required performance using only three RF stages, detector, and one VF stage, a total of five valves as compared with the seven or eight which would be needed if we fed the CR tube directly from the detector. Provided that we can overcome its disadvantages, therefore, the use of a VF stage leads to a considerable saving in cost. It also assists in promoting stability, for as it ceases to amplify at 45.0 Mc/s the effective gain from input to output at signal frequency is only the RF gain, about 2,375 times, as compared with 50,000 times if a VF stage were not used. Less screening is consequently needed.

Now for the three-valve amplifier we require tuned circuits with dynamic resistances of 1,870 ohms. At 45.0 Mc/s we certainly cannot obtain this merely by shunting the coil by a resistance of this value, for owing to the transit time of the electron the input impedance of an RF pentode is of the order of 3,000 ohms only. The coil losses will also be appreciable, and we shall actually be doing quite well if we succeed in obtaining an effective dynamic resistance of 1,870 ohms without intentional damping. In fact, unless we are careful, we shall have to use four RF stages to provide the gain because we cannot build good enough circuits to get it with three.

ON THE SHORT-WAVES

AS there must be many listeners not familiar with the B.B.C.'s system of short-wave relays, a brief explanation of how they are arranged might be of general interest.

These relays are made either from the Tatsfield receiving station or via the G.P.O. radio-telephone system.

In the case of the former the relay is always by direct reception of the U.S. short-wave broadcasting stations, such as W2XAD, W3XAL, etc., and these stations do not increase power for this purpose, but

they undoubtedly use their European beam aerials whenever possible.

"Five Hours Back" and the commentaries on the America Cup Races are some examples of this type of relay.

The G.P.O. Transatlantic radio-telephone service is generally used for programmes especially arranged overseas for the B.B.C. and not generally radiated in the country of origin, i.e., America, Australia, India, etc. For these relays the radio-telephone transmitters of the American Telephone and Telegraph Company at Lawrenceville are used. These excellent transmitters, WLA, WKN, WKF, WMF, etc., generally appear on the dial with wobbled carriers modulated with inverted speech, but may occasionally be heard (see broadcast licence) radiating high-quality programme material with the inverter and wobbler inactive. They are then probably being intercepted at Baldock,

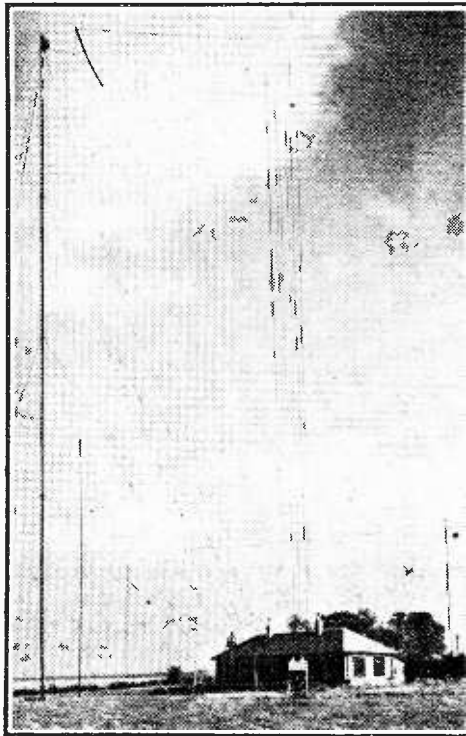

The B.B.C. receiving station near Tatsfield where short-wave transmissions are picked up for re-broadcasting in this country.

in Herts, and the low-frequency signal passed to Broadcasting House by land-line.

Examples of this type have been Rudy Vallée in the recent Savoy Orpheans' programme and the regular broadcasts by Raymond Gram Swing, a popular Transatlantic feature.

A most interesting mixture of these two types was the recent inaugural address of President Roosevelt, when the commentary by Felix Greene prior to the President's address arrived by radio-telephone—but the voice of the President himself was taken via Tatsfield, using, I am informed, four receivers in diversity and giving really excellent reception from W2XAD.

The transmitters of the R.C.A. group at Rocky Point are not used for programme transmission to this country except for special experiments, although they have often in the past been observed working Geneva and Berlin.

I hope that this explanation will clear up any doubts which may have existed in the minds of readers. At present the reception via Tatsfield generally seems to be a little up on the G.P.O. relays, probably due to

the use of the diversity scheme, which, under all but very unfavourable conditions, practically eliminates fading and distortion.

The statement made by Professor Appleton in his broadcast talk recently, that the effect of sunspot activity on the reflecting layers may be likened to impairing the reflecting properties of a mirror by breathing on it, seems to me a rather unfortunate choice of an analogy.

It has always been understood, and it has been adequately demonstrated, that the effect of sunspot activity is to improve the reflecting properties of the layers enormously for about 90 per cent. or more of the time; during the rest of the time, generally for not more than a few hours every 27 days, the absorption in the E region (i.e., a cloudiness in the glass face of the mirror) is enormously increased due to bright hydrogen eruptions, so that the signals during these brief periods never reach the reflecting layer.

It is very interesting to note that the peak European short-wave field strengths received in New York since my records were started occurred around February 23rd-25th of this year, a period of exceptionally great sunspot activity. On one day the Empire transmitter GSD produced a field of 67,000 microvolts and very strong signals were recorded from the vision transmitter at Alexandra Palace on 45 Mc/s!

Turning once again to a review of conditions, it will be seen that reception has deteriorated on the very high frequencies from April 8th, no signals at all having been heard on 28 Mc/s recently, at least in the evenings. Reception has generally been good on 15 Mc/s and lower.

On Thursday, April 8th, W9XAZ was fair at 7.30 p.m. (G.M.T.) and W1HLH good on 28 Mc/s 'phone; at this time W2XAD was good but W3XAL was unheard.

Reception on 28 Mc/s was good on Saturday, April 10th, whilst W9XPD, St. Louis, was very good on 31.6 Mc/s at 6 p.m. The Brazilian transmitter PRF5 on 9.50 Mc/s was quite good at 10.45 p.m. (French transmission).

Ten metre conditions were a bit poorer on Sunday, but W3XAL on 17.78 Mc/s was very good at 9.30 p.m., and W1XK very good at 11.30 p.m. on 9.57 Mc/s, but rather spoilt by carrier hum; W2XAF was good, too, but weaker and HJU Buenaventura heard as a heterodyne under GSB.

Conditions were definitely poor on Monday, April 12th, but improved again on Tuesday.

One was particularly amused by PCJ on 9.59 Mc/s at 7.55 p.m. on Tuesday, the announcer stating after some English records of a distinctly nautical flavour, "Join the PCJ Navy, we have for ten years the best navy on the short waves." Well done, PCJ, we who remember PCJJ!

Excellent reception was obtained from W2XAD on Wednesday—this first-class station now appears to be working until later than midnight (G.M.T.).

An outstanding signal Saturday afternoon was W2XE on 21.52 Mc/s, it being understood that the increase in signal, a considerable increase, was due to the use of the new transmitter.

Up to Tuesday, April 20th, conditions have remained good, all the regulars, W2XAD, W1XK, W8XK, W1XAL, etc., have been of programme value; W3XAL has been good, too, when radiating, but is operating irregularly at the moment. Reception of W2XAD has generally been "local station" after 10.30 p.m. B.S.T.

ETHACOMBER.

BROADCAST NEWS FROM PORTLAND PLACE

BREVITIES

A Coronation Problem

ALTHOUGH Coronation Day will be a public holiday, nearly 150 people will be on duty for the day's broadcasting activities. Some of the luckier ones may have no difficulty in reaching Broadcasting House on the morning of the great day, but others, less fortunately domiciled, already foresee impassable traffic barriers and are arranging to spend the previous night in the neighbourhood of Portland Place.

Camping in Portland Place

Luckily, there is close at hand the shell of an old family hotel which has been denuded of its furniture, having passed into the hands of the B.B.C. for the purpose of big studio extensions during the next two years. In this building more than a hundred camp beds are to be installed, with Army blankets and other military appurtenances for the convenience (sic) of the hard-worked officials. Furnaces will be started up once more, so that h-and-c will be available in all rooms and there will be eggs and bacon for breakfast.

Among the hardy pioneers will be the Chief Engineer himself.

Too Comfortable ?

The B.B.C. is anxious not to make this ancient hostelry too comfortable, the fear being that the staff may actually enjoy their stay there. If this happened, it might be difficult to turf them out, and a building destined to become a hall of Terpsichore might degenerate into a home of rest for tired broadcasters.

Welcome to St. George's Hall !

THE secret is out! When next you receive a gold-edged invitation to attend a broadcast performance in St. George's Hall, pause to reflect that you go as a welcome guest—but welcome for reasons you may not have considered.

Human Sound Absorbers

The truth is that the rearrangement of studio acoustics is a difficult and expensive undertaking, particularly when reverberation response has to be altered at short notice. It can be done, of course, with movable walls, or with vast supplies of damping material, but the engineers find that by far the

most expeditious way is to import human sound absorbers.

A Mixed Bag

It is all carefully worked out. To reduce the reverberation period by two seconds you must employ, say, fifty human sound absorbers. So this is one reason why fifty or seventy-five, or perhaps a hundred neatly typed invitations to Music Hall find their way into the homes of the people. Fat people, of course, absorb more sound than the thin ones, but by the law of averages fifty invitations yield a nice mixed bag.

Coronation Commentators : Who's Who

THE seven Coronation commentators have had varied careers. The Rev. F. A. Ire-monger, who will be stationed with Howard Marshall in the triforium of Westminster Abbey, has been Religious Director of the B.B.C. since 1933. He was made Chaplain to the King in 1927. Howard Marshall gained a Rugby Blue at Oxford, and has the distinction of having joined the B.B.C. staff twice,

Woodroffe makes a commentary sound like a man-to-man talk. He also can tackle anything from a Rugger match to a State occasion.

New Opportunities

George Blake is Scotch, but not dour. First leaped into fame with his ecstatic commentary on the launching of the "Queen Mary." Harold Abrahams, the great Cambridge athlete who holds the English long jump record of 24 ft. 2½ in., has previously specialised in sporting commentaries. The Coronation Procession will give him his big chance to describe a slow-moving event. Michael Standing worked in the City for eight years before joining the B.B.C. Talks Department in 1935. Later he joined the "O.B." Department. Coronation Day provides him with his first big occasion as a radio observer.

Historic Television Camera

TELEVISION as an art is still in the self-conscious stage, and a happy token of this will

in the proceedings the whole of the television squad in Hyde Park will be shown.

Freddie Grisewood's Problem

Mr. Gerald Cock, Director of Television, is personally supervising the arrangements in Hyde Park, and an elaborate continuity has already been prepared, provision being made for every conceivable eventuality, from a stampeded crowd to a thunderstorm.

There will be two microphone points, one on each side of the Arch, and Mr. Freddie Grisewood, who is giving the commentary, will oscillate between the two in a laudable attempt to see both ways at once.

Fortunately, the "mikes" will be movable.

Telephoto . . . if Weather Permits

Telephoto lenses will be used only if the light is really good. Their use is not so vital as many people think; in fact, one school of thought considers that telephoto lenses involve too big a sacrifice of light and also give an artificial effect to the picture owing to the flattening out of the perspectives, which is particularly noticeable in the case of objects approaching the camera.

Televising the King and Queen

The pavement camera will "take over" from its companion on the plinth platform when the head of the procession comes within thirty or forty feet of the Gate. It will be less than six feet from the Royal coach, and should yield excellent close-ups of Their Majesties.

Co-axial Festoons

There will be no risk of public gate-crashing on the camera positions. Two of the cameras will be inside the railings of the Gate throughout the proceedings, and the pavement camera will be similarly protected until the Gate is closed to pedestrian traffic at about 9 a.m.

An inconspicuous festoon of co-axial cable will link cameras with the mobile television unit, which will be located in a special enclosure about 100 yards away in Hyde Park just north of the park-keeper's lodge.



INDIAN STUDIO SCENE. Under the New Rural Development Scheme the Government of India is rapidly arousing interest in broadcasting.

and left it twice. This all happened between May, 1929, and September, 1930. He can paint a word-picture of anything from a Royal Jubilee to a boxing match.

Versatile Talkers

John Snagge, who will be installed opposite Buckingham Palace, is an Oxford man and loves boats. Excels at boat races and launchings of liners. Lieut.-Commander "Tommy"

be observed when the Coronation Procession is televised. Just before the procession comes into view in the East Carriage Drive beside Stanhope Gate the camera on the platform to the north of Apsley Gate will be trained on the pavement to show viewers the camera which is to have the honour of televising Their Majesties the King and Queen for the first time.

The camera operator will also come into the picture, and later

Practical Push-Pull

HARMONIC DISTORTION AND PARASITIC OSCILLATION

THE two earlier articles¹ have prepared the ground for this one, which is intended to help you make a success of actually using the push-pull circuit. But as the first practical point is to be a reminder that one of the main advantages of push-pull applies to triodes and not to pentodes, and as I hate anything like throat-ramming, here is a quick bit of theory to justify my statement.

Looking at the characteristic curves of a triode, Fig. 1, it is easy for anybody who is accustomed to diagrams to see that in so far as the curves are not straight lines the tendency is for them to yield a lopsided output wave, with the positive half bigger than the negative half. Drawing an undistorted wave and, on the same base line, another of twice the frequency (a so-called second harmonic), by adding them together (Fig. 2a) one can see that the result is also a lopsided wave with the positive half bigger than the negative half. "Things equal to the same thing are equal to one another." Therefore, the distortion introduced by a triode is equivalent to the introduction of a second harmonic. Now, in a Class "A" push-pull system there is an additional valve amplifying at the same time but connected so that the signal wave is reversed (Fig. 2b). The second harmonic is still in such a direction as to stunt the negative half-wave, however. To get the output the output transformer is connected so as to reverse the waves once more, and by adding Fig. 2a upside down to Fig.

¹ "About Push-Pull," April 9th; "About Push-Push," April 23rd.

2b it is seen that the true, original and undistorted waves add up, while the false and spurious distortion waves cancel out.

Now, going through the same reasoning for a pentode when the slope of the

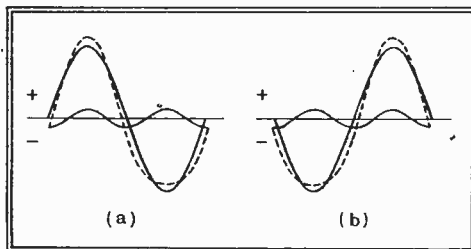

Fig. 2.—Diagram (a) shows that the result of asymmetrical amplification (see Fig. 1) is equivalent to an undistorted wave plus a second harmonic; meanwhile, the other valve is acting as in dia. (b). Adding the inverted result to Fig. 2 (a) the pure waves and the distortion cancel out.

load line (i.e., the selected resistance of the load) is chosen, as it usually is, to give equal up-and-down swings, avoiding the lopsidedness or second harmonic, it is possible, though not quite so easy, to see that owing to the relative crowdedness of the grid voltage lines towards the ends of the load line, corresponding to the peaks of the wave, there is a tendency for the peaks to be flattened. Fig. 4a shows how a third harmonic duly yields this result. Fig. 4b is the output from the second valve; turning it upside down and adding it to Fig. 4a, one finds that unfortunately the distortion is additive as well.

Please note that this argument depends on the pentode being used in its normal fashion, with the grid bias and the load

resistance adjusted for negligible second harmonic. If it is worked quite differently, as in Class "B," the conclusion of the argument is, of course, different, and some reduction of distortion may be effective. But whereas third harmonic is almost negligible when triodes are used in any normal fashion, it is always a prominent ingredient in pentode distortion, and no sort of push-pull is able to purge it of this blemish. So this is a point to be set off against the increased power efficiency of pentodes. Another, but perhaps less important, bad mark against pentodes in push-pull is that, unless precautions are taken, parasitic oscillation is the rule, rather than the exception that it is with triodes. That brings us to parasitic oscillation. At the end of the first article I briefly mentioned the usefulness of the push-pull circuit in stimulating difficult (e.g., ultra-short-wave) circuits to oscillate. This trait is less admirable in audio-frequency amplifiers. If the wiring to the grids and anodes, together with the capacities of those electrodes, comprises an ultra-short-wave oscillating circuit; or if leakage inductances of input and output

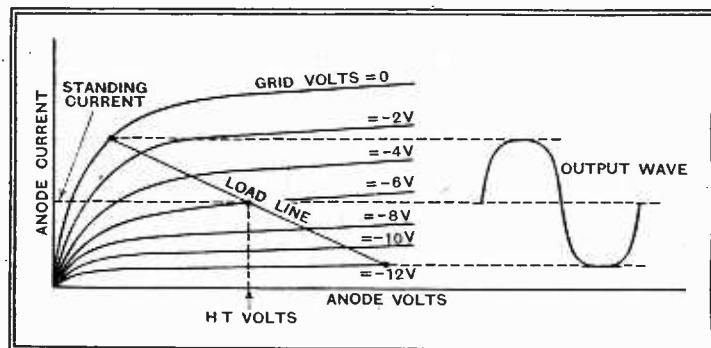

Fig. 3.—Typical pentode characteristic curves; compare with Fig. 1.

transformers help in setting up oscillation at some frequency above audibility, the valves are in no fit state to undertake high-quality amplification.

The awkward thing is that without special equipment the existence of these oscillations may go undetected; one is merely disappointed by the poor show put up by the amplifier. If the oscillation is continuous it may often be spotted with the help of nothing more than a millimeter and a damp finger, by connecting the one to read anode current and applying the other to each grid in turn. A change in anode current gives a clue to oscillation. But much more elusive is the intermittent variety, which occurs only when the amplifier is delivering volume, perhaps at some particular stage in the signal wave (Fig. 5), or at some particular frequency. The audible effects are elusive, too. A variable-frequency oscillator and cathode-ray tube are needed to detect this positively, and as such equipment is not

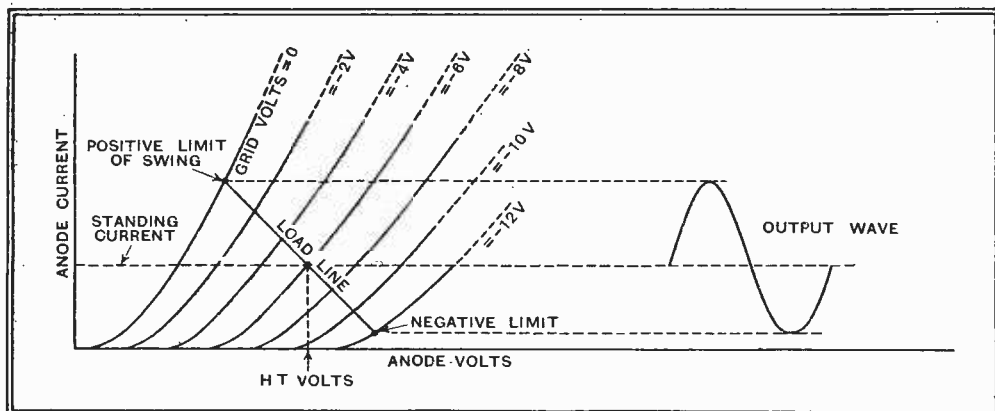

Fig. 1.—Typical triode characteristic curves, showing that one half-wave is amplified slightly more than the other.

Points

By "CATHODE RAY"

generally at hand the only thing to do is to take suitable precautions. Long grid and anode leads, particularly if they are curved or run close together, encourage oscillation. Make them absolutely as short and direct as practicable. Small non-inductive resistors connected close up to the valves in each grid and anode lead are sometimes helpful; 100 ohms is about as much as can be put in the anodes without undue loss of volts, but 1,000 ohms is

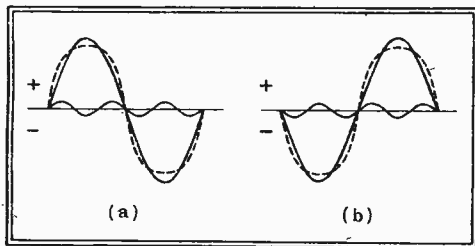

Fig. 4.—Equivalent to Fig. 2, but applying to pentode valves. The unfortunate difference is that both pure wave and distortion appear in the final output.

suitable for grids. A simpler and more effective method is to connect a resistance of about 100,000 ohms as in Fig. 6, but if this is done it is even more than usually desirable that the intervalve transformer, or other coupling, should be well balanced. When a transformer secondary is just wound on straightforwardly and a centre-tap made, the two halves of the winding are far from being equal in resistance and stray capacities. It is preferable, but slightly more expensive, for the two halves of the secondary to be symmetrical.

Transformer v. Resistance

Incidentally, is the transformer the best sort of coupling for push-pull, and, if so, why? It has the advantage of giving the necessary two-phase output for providing the push-pull valves with signals of opposite polarity. Resistance and choke couplings can be made to do this only by means of some dodge or another, which may even involve an extra valve. Then the transformer gives a step-up in voltage, which is particularly valuable because each push-pull valve gets only a half share, and if each requires perhaps 100 volts swing the total needs a rather big preceding stage to supply it without a step-up. Another advantage, provided it is not sacrificed by including a high-resistance grid decoupling filter, is that if the amplifier is occasionally overloaded, the resulting pulses of grid current pass rapidly to cathode, instead of causing a more unpleasant form of distortion due to momentarily choking the valve by charging up a grid condenser, as happens with resistance coupling. The effect of

this is to give a much larger output on ordinary programmes (in which extreme peaks occur only seldom) before distortion becomes intolerable. The rated output in watts is therefore not an infallible guide to the relative volumes obtainable from different amplifiers under working conditions.

There are two sorts of intervalve transformer that may be favourably considered for push-pull, assuming one is going for a high-quality outfit. The first is a small parallel-fed nickel-iron core type, which is very cheap. It also gives a flatter frequency characteristic than the most expensive straight type, and the stray capacities are lower. But the very small ones, about an inch cube, are liable to saturate at the lowest frequencies—50 cycles and downwards—if called upon to supply more than 20 or 30 volts from grid to grid. Within these limits the performance is practically perfect over the widest audio-frequency band. But for valves requiring large grid voltages, to maintain full undistorted output at the lowest frequencies it is necessary either to go in for a larger parallel-feed transformer or a high-quality and expensive example of the directly connected sort, and to make sure that the preceding valve is working well within its capabilities.

Some makers bring both ends of both secondaries out to separate terminals, which gives rather more scope in arranging the circuit, particularly as regards grid bias. That is our next point, and a more important one than might at first sight appear. There are so many variations, all having their special advantages and snags. Fig. 7 shows a few of them. If the cathodes of the valves are indirectly heated, each valve can be separately biased by a voltage-dropping resistor R as in (a). The great advantage of this scheme is its self-compensating property. The anode current of a valve, taken at random and supplied with the rated anode and grid voltages, may be considerably different from normal. It is impracticable to make valves within very close limits. But with self-bias the abnormal anode current automatically adjusts the grid bias in such a way as to bring itself nearer normal. And if a

separate resistor is provided for each valve, any wide difference between them in current is very much reduced. As the success of push-pull depends largely on the two sides being reasonably well matched, that is a very great point in favour. Again, a change in valve characteristics due to age is automatically counteracted. And the risk of damage to valve or power unit due to the grid bias coming off is a minimum.

The only criticism of the circuit as shown is that the signal currents produced by each valve also flow through R , and feed back voltages to the grids. In certain circumstances this may be good—I explained what happens in "Degeneration" (5.3.37)—but if it takes place in the way shown here the adverse effects are the most likely to be felt. So condensers CC (b) are used to short-circuit the signal currents. Unless the short-circuit is effective at all the desired frequencies, such condensers are rather worse than nothing at all: A 500-ohm bias resistance needs at least 25 mfd., and a smaller resistance a proportionately larger one. A condenser, say 50 mfd. to work at 50 volts, even if of the electrolytic type, is quite costly, so a possible alternative is (c), in which the choice of condensers CC is calculated on resistances $R'R'$, which may be as high as can safely be allowed in the grid circuits of the power valves. Values of 0.1 megohm and 1 mfd. are typical. The disadvantages are liability to the overloading distortion effect (which I mentioned in connection with resistance coupling), the necessity for separate secondary windings, and ineffectiveness when applied to parallel-feed or other condenser-coupled systems.

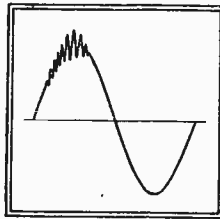

Fig. 5.—Example of intermittent oscillation, very difficult to trace in an amplifier.

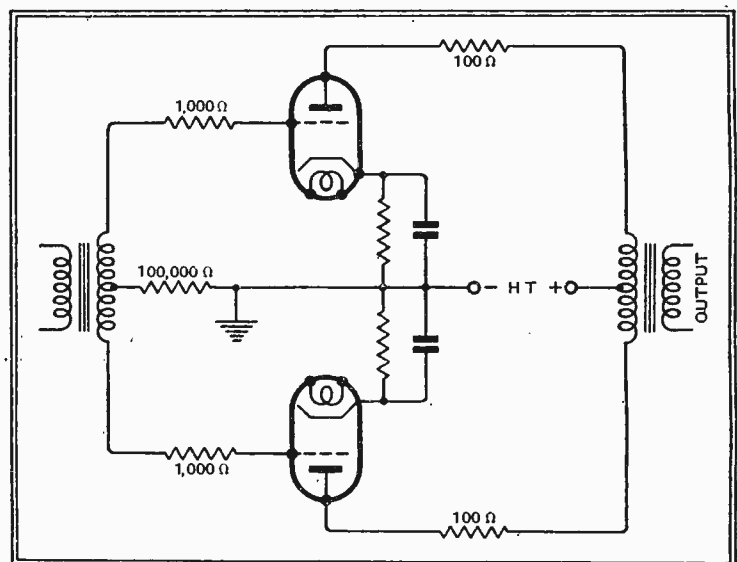

Fig. 6.—Anti-oscillation devices.

If the self-balancing property of separate biasing resistors is sacrificed, the delightfully simple (d) circuit abolishes these tiresome feed-back difficulties. The signal currents of the two valves cancel out. But it is cleverer even than that. If the valves are not perfectly matched for mutual conductance, and there is a balance of signal current, it works in such

Practical Push-Pull Points—

a way as to strengthen the weaker valve and hold back the strong one. Valves are more easily matched for anode current than for conductance, so this circuit has much to recommend it. Not least is the fact that, unlike (a) (b) and (c), it can be used for directly heated valves in which only one battery or transformer winding is available, as in (e). The (a) (b) (c) systems, if applied to directly heated valves, require separate supplies; (f) is an example.

diode in one of the valves (h). The disadvantage of these independent bias systems, apart from absence of the self-compensating property, is that if anything goes wrong with them there may be some heavy consequential damage.

There is a certain amount of strain on the remaining valve if one is pulled out when the power is on, and this applies especially to circuits such as (d) and (e). But if you do unplug one and think there is something wrong because it makes very little apparent difference, it is quite all

circuit. One is wise to allow for some polarising current in the transformer, and to include some decoupling of the anode supplies to preceding valves.

Then as regards transformer ratios there is sometimes confusion. When an intervalve transformer is marked "4:1 ratio," it should be "1:4" unless it is a positive-drive Class "B" type. And presumably it refers to the ratio between primary turns and the whole of the secondary turns, grid to grid. To steer clear of all confusion it would be helpful

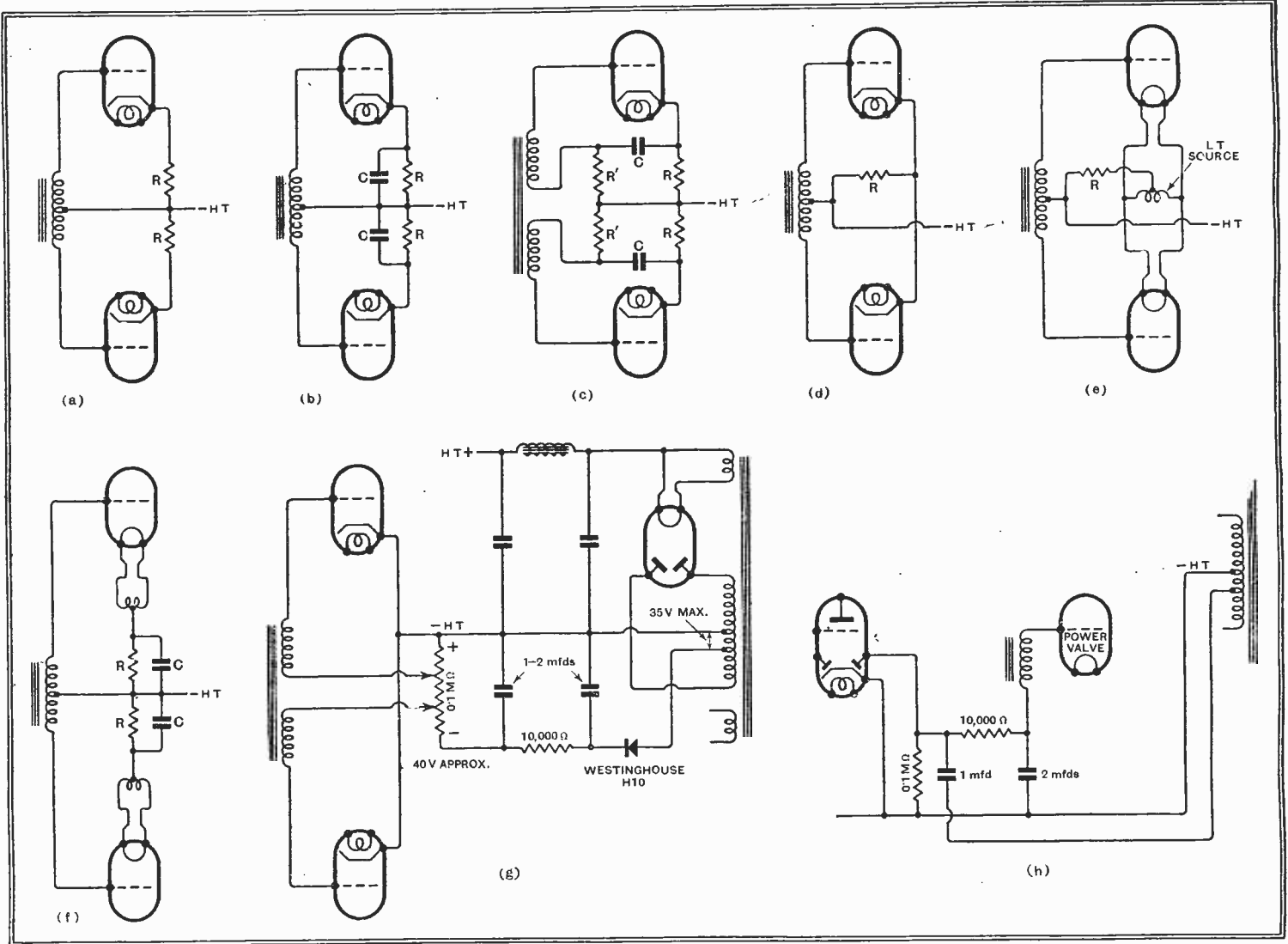

Fig. 7.—The various grid-bias schemes described in the text.

Systems in which the anode current when giving full output is more than the quiescent anode current—Class "AB," QPP, etc.—are not satisfactory with self-bias, and some source of bias which does not depend on anode current must be found. It is extraordinarily difficult to find, unless, of course, one descends to the use of a grid battery. A method that has been successfully used is shown in (g); a tapping on the HT winding of the power transformer supplies a suitable voltage through a metal rectifier and simple filter. Typical circuit values are given. And note the method of using separately adjustable bias to equalise anode currents. But don't put the bias controls on the front panel for anybody to use! An alternative rectifier is a spare

right really. The usual reason for pulling out one valve at a time is to measure the separate anode currents; but this is a futile and risky proceeding, so a better way is to connect a milliammeter to read the current to either or both valves.

In my discussion of the benefits of push-pull I mentioned such things as the absence of polarising current in the output transformer, the absence of signal currents in the HT source, and so on, leading to certain simplifications in the design of the circuit. In a practical article such as this it is necessary to point out that such conditions will in general be only approximate—and not even that if one is careless about matching valves. They are not results that follow perfectly and inevitably from using the push-pull

if makers listed it as "1:2+2." As push-pull valves are, so far as signal voltages are concerned, in series, the optimum load resistance approximates to twice that specified for a single valve of the same type. Approximates; because ideally it is seldom exactly double, and under special conditions of working may be quite a lot different.

MATERIALS AND TESTING

A BODY under the title of "The Joint Committee on Materials and their Testing" has now been set up by a number of technical institutions and societies (including the I.E.E.). The address of the committee is: c/o The Institution of Mechanical Engineers, Storey's Gate, London, S.W.1. It will promote discussions of the wider aspects of its subject, assist co-operating institutions and undertake duties with respect to certain international matters.

New Apparatus

Reviewed

Recent Products of
the Manufacturers

WEBB'S APEX SW CONDENSERS

A RANGE of short-wave condensers described as the Apex Economy models has been introduced by C. Webb, Ltd., 14, Soho Street, London, W.1, and these are made in sizes of 15, 40 and 100 mmfds.

These are of quite small dimensions. For example, the 100 mmfds. model measures only 1½ in. by 1½ in. by 2½ in. with the vanes extended. The 2½ in. is from back to front, being the space taken up behind the panel.

They are made of brass with one large bearing for the rotor, this and the fixed vanes being supported on a triangular-shaped plate of ceramic insulating material. Provision is made for ganging.

Tests have been made with the 15 and 100 mmfds. condensers and these have been found satisfactory for both short- and ultra-short-wave use. There is no trace of end or side play, and they are quite silent in use on all frequencies.



Webb's new Apex Economy condensers and short-wave valve-holder.

The measured capacities of the 15 mmfds. specimen were 3.5 mmfds. minimum and 16.3 mmfds. maximum. The larger model had a minimum value of 6.3 mmfds. and a maximum of 84 mmfds.

Though extremely well made the prices are very low, being 1s. 6d. for the 15 mmfds., 1s. 9d. for the 40 mmfds., and 2s. for the 100 mmfds. sizes respectively.

At the same time we have examined some samples of the new Webb's short-wave chassis valve-holder. Available in 5- and 7-pin types, it has a ceramic plate and the price is 6d. for the former and 9d. for the latter.

They are quite satisfactory for all short- and ultra-short-wave work.

WOLF ELECTRIC SOLDERING IRONS

ALTHOUGH an elaborate kit of tools is not essential for home constructional work the radio amateur can rarely do without a soldering iron. Electric models have been available for some years, but improvements are continuously being made and the latest types are extremely reliable.

Among the many different models made by S. Wolf and Co., Ltd., Pioneer Works, Hanger Lane, Ealing, London, W.5, are several that are intended especially for the type of work undertaken by the radio amateur. Of these possibly the Model 102, which is fitted with an 80-watt heater element, is the most suitable. It has a copper bit ½ in. in diameter.

One of these 80-watt electric soldering irons has been tested and found very satisfactory for all types of radio construction. The iron heats up quite quickly and very soon after switching on is hot enough for use. When continuously in use the iron does not become too hot, but during long periods of idleness there is a tendency to overheat unless the copper bit is rested on a block of iron—though a moderately large piece of sheet iron or aluminium would serve just as well—to conduct away the surplus heat.

This iron, known as the Type 102, costs 9s. 6d.

The other model we had sent to us for examination was the K100, which consumes 100 watts and is well suited for continuous work, such as in factories, etc., though the amateur requiring an iron that will handle somewhat heavier work than merely soldering wires and light joints as in radio construction will find it very useful. This costs 16s. 6d.

There are many other styles of electric soldering irons in the Wolf range, and it will be of interest to readers to know that copper bits of various shapes and sizes are available for all the models. Bits and heater elements can be easily replaced whenever necessary.

BULGIN INDICATOR RESISTANCE

THERE are many uses to which a calibrated variable resistance can be put in experimental work. By including it in the circuit the correct value for a fixed resistance is easily found by adjusting the variable and then reading off from its scale the amount of resistance in use.

It provides a ready means for ascertaining the actual value of an unmarked

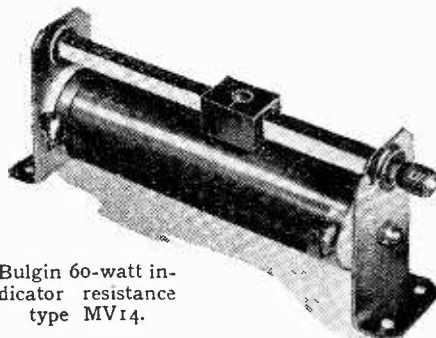

Bulgin 60-watt indicator resistance type MV14.

resistance when other means for resistance measurement are not available, so that servicemen and radio dealers can find many uses for it.

A. F. Bulgin and Co., Ltd., Abbey Road, Barking, Essex, make two models of this kind; one has a total value of 10,000 ohms and the other of 50,000 ohms.

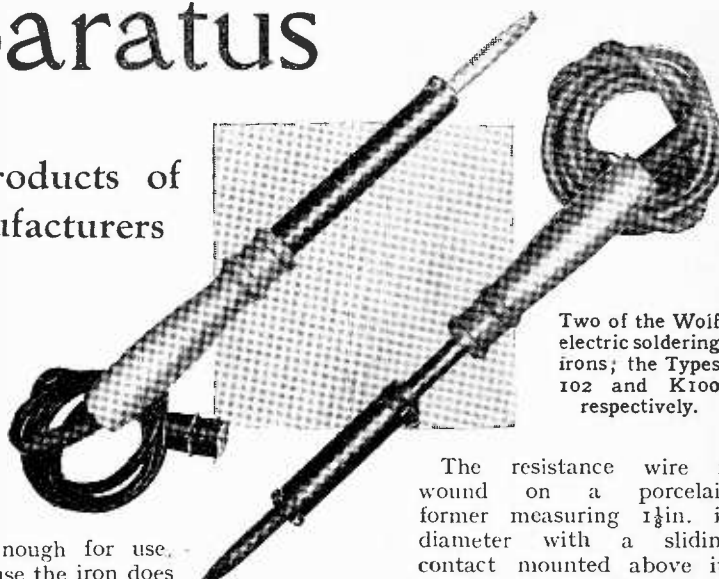

Two of the Wolf electric soldering irons; the Types 102 and K100 respectively.

The resistance wire is wound on a porcelain former measuring 1½ in. in diameter with a sliding contact mounted above it.

This moves along a square-section bar on which a 0-10 scale with sub-divisions is engraved. These divisions are visible through an aperture in the slider on which an indicator line is engraved.

Tests were made with the 10,000-ohm model Type M.V.14, and measurements show that the calibration is accurate to within two per cent. at all parts of the scale.

This resistance is rated at 60 watts and as it is intended to carry up to 77 mA it was also tested with a current of this value flowing through it.

When dissipating 60 watts considerable heat is, of course, generated, but the wire did not show any signs of being overtaxed, nor did the turns become loose. The resistance was as sound after the full-load test as it was before.

As three terminals are fitted the resistance can be used as a calibrated potential divider, and if supplied with a known AC voltage it provides the means for calibrating valve voltmeters and other test apparatus of a like nature.

This resistance is very robust, it is well made, and all the metal parts are nickel-plated. The 10,000- and the 50,000-ohm types each cost 10s. 6d.

CR Tube Data

WE are informed that in the data given for the Baird cathode-ray tube in *The Wireless World* for April 2nd, 1937, the figure of 70 volts p-p for the modulation input may be misleading as the tube normally operates with an input of 30 volts p-p only. The figure given of 70 volts is correct for the limits of black and defocusing.

42 YEARS OF MOTORING

Pioneer Journal's

Notable Coronation Number

THE oldest of the motoring journals, *The Autocar*, which was founded in 1895, the year in which His Majesty King George VI was born, is fittingly celebrating the Coronation with a special issue dated April 30th.

This Coronation Number is printed with full colour sections on art paper and with other special two-colour sections. Superb coloured portraits from oil paintings of their Majesties are included, and a history of the British automobile industry from the inception makes this greatly enlarged issue a permanent record of value to all interested in motoring. The price is sixpence.

MAY Day always conjures up in one's mind the idea of the open-air and the countryside. The B.B.C. must have been infused with a longing for the wide, open spaces when planning the programmes for Saturday, May 1st. As announced in Broadcast Brevities last week, the Outside Broadcast Department will have a very full day. At 1.15 and 4.45, P. G. H. Fender will describe the progress in the county cricket match between Lancashire and Derby from Old Trafford, Manchester. George Allison and Ivan Sharpe, at Wembley Stadium, will, from 2.45 to 4.45, describe the great battle between Sunderland and Preston North End for the F.A. Cup.

Brooklands motor race track will be visited at 5, where F. J. Findon will comment upon the scenes at the first race over the recently completed road circuit, and will describe the efforts of the competitors during this 220-mile race. Leaving Brooklands at 5.15, the listener will then be taken over to Bourne-mouth, where, until 6 o'clock, Major Cooper-Hunt will describe the progress of the competition in the finals of the Hard Courts Tennis Championships of Great Britain. All the above will be radiated Nationally, but the Outside Broadcast Department's May Day activities are not even then exhausted, for Regional listeners will later in the evening have three further O.B.s.

At 9 the microphone will be taken to the Mendips, where a party will be heard descending into Swildon's Hole. For some four hundred feet they will be crawling along slippery ledges in the caves, ever and anon guarding against a false step which

Listeners' Guide for

Outstanding Broadcasts at Home and Abroad

might thrust them into what appears to be a bottomless pit.

Bidding farewell to potholes, listeners will, at 9.20, be switched over to the first of two "indoor" O.B.s. Willie Smith at Thurston's Hall will describe the last session of the match between Joe Davis and Tom Newman in the United Kingdom Professional Billiards Championship. Following this at 9.45 "Tommy" Woodroffe will describe for listeners the scene and some of the pictures at Burlington House prior to the Royal Academy Banquet. From the banquet itself Lord Macmillan will be heard proposing the toast, "The Royal Academy of Arts." With this broadcast ends a hectic day for the O.B. engineers.

MUSIC

ON Sunday, at 10, Regional listeners will hear the second broadcast in the new series, "Music for Worship," the work chosen being Handel's anthem, "O Come, Let us Sing Unto the Lord," which will be sung by the B.B.C. Chorus. This anthem is one of the twelve Chandos anthems so-called because they were written when Handel was Kapellmeister to the Duke of Chandos and were intended for performance in his private chapel at Edgware.

There will be a first performance on Thursday at 9.20 (Nat.) of a new work by Sir Granville Bantock entitled "King Solomon" which the composer himself will conduct. The work which is for chorus

HILDEGARDE, the well-known American cabaret artiste who will be heard in a cabaret entertainment, Caf' Chart, to be presented by Archie Campbell on Tuesday at 9.40 (Nat.). She starred in the N.B.C.'s first television Press demonstration and will be seen by viewers on Thursday at 9.30.



and orchestra, will be sung by the London Select Choir. It is based on the 21st and 148th Psalms, and the first chapter of the second book of Chronicles. There is a part for a narrator which will be taken by Harmon Grisewood, the announcer.

RADIO REVIEW

THIS week's Saturday night alternative to the fortnightly Music Hall programme is entitled "Radio Review," which Bryan Michie will present as a review of radio artistes from 1922 to 1937. "Radio Review" will be heard by National listeners at 8. It will be an intimate, personal programme introducing many well-known artistes. This will be the first occasion that C. H. Middleton, the

QUACK REMEDIES

PETER CRESSWELL is to present a farce entitled "Beware of Influalgia," specially written for the microphone by a new author, H. R. Jeans, on Sunday at 9.55 (Nat.). The play deals with the rivalry between two firms who manufacture patent medicines. The proprietors of "Flyo," who are on the verge of bankruptcy, hit upon the idea of inventing a new disease that can only be cured by taking their medicine.

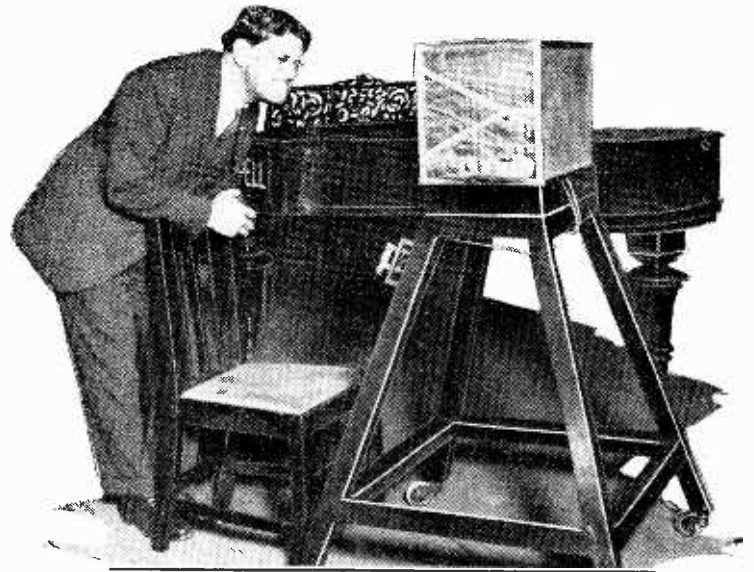

SAVOY HILL DAYS. This photo of Bransby Williams was taken during a broadcast in 1925. He will be heard on Sunday at 7.30 (Nat.) in selections from his repertoire with Reginald Foot at the Theatre Organ.

gardening expert, has come into a variety programme. Others who will be heard include Hughie Greene, *without* his gang, Henry Hall at the piano, Jeanne de Casalis, and Gypsy Petulengro.

SATIRE ON SELFISHNESS

IN 1924 Richard Hughes wrote "Danger," the first play ever written solely for British broadcasting. His latest radio play "We Gave Our Grandmother," a light comedy satirising the selfishness of the younger generation, will be produced for Regional listeners on Monday at 7.30 and Nationally on Wednesday at 9.20. Students of radio-dramatic technique will be interested in the style adopted by the author for the presentation of this microphone play.

The manufacturer of "Choko," finding his sales dropping, persuades his daughter to go as a typist with the rival firm in order to steal their formula. A series of diverting situations results, and with romance by no means neglected the farce should prove ideal for broadcasting.

CINEMA VARIETY

WE are to hear another variety programme from the Union Cinema, Kingston-on-Thames, on Thursday at 7.50 (Nat.). Harold Ramsay, the organist at the cinema, is responsible for this May edition of "Radio Rodeo." He has "roped in" many well-known radio artistes, including George Robey, Clapham and Dwyer, the Carlyle Cousins, Gypsy Nina, the Ladies' Accordeon Band, and the Gordon Ray

eWeek

HIGHLIGHTS OF THE WEEK

FRIDAY, APRIL 30th.

Nat., 8, Songs from the Films.
9.20, The Rt. Hon. Winston Churchill on The Responsibilities of Empire.
Reg., 7.30, Melody Out of the Sky.
8.15, Act I of "Turandot" from Covent Garden. 9, Robinson Crusoe, music from comic opera.

Abroad.

Vienna, 9, Vienna Philharmonic, conductor Bruno Walter.

SATURDAY, MAY 1st.

Nat., Commentaries: 1.15, County Cricket; 2.45, Cup Final; 4.45, County Cricket; 5, Brooklands Road Race; 5.15, Tennis Championships. 8, Radio Review.

Reg., 6, Songs from the Films.
7.30, Recital of Gretchaninov's songs by Tatiana Makushina with the composer at the piano.
8, "Music in the Air": the life and work of Edward Elgar.

Abroad.

Bucharest, 8.15, "Eva"; three-act operetta (Léhar).

SUNDAY, MAY 2nd.

Nat., 6, "I Knew a Man"; Tom Clarke on Lord Northcliffe.
7.30, Bransby Williams. 9.55, "Beware of Influenza."

Reg., 5.40, Talk: the Paris Exhibition. "Students' Songs. 7.15, Pianoforte Recital, Kathleen Long.

Abroad.

Frankfurt, 8, Puccini's "Tosca."

MONDAY, MAY 3rd.

Nat., 7, "Monday at Seven."
"Julius Harrison String Ensemble.
Reg., 7.30, "We Gave Our Grandmother." 8.20, "Antigone" from Swansea.

Abroad.

Munich, 8.10, Gala Military Concert—bands and soldiers' chorus.

TUESDAY, MAY 4th.

Nat., 5.15, Julius Kantrovitch and his Orchestra. 9.20, Sir James Jeans. 9.40, Caf' Chant—cabaret entertainment.

Reg., 7.30, Tommy Matthews and his Concert Orchestra. 8, Kai Ewans and his Orchestra from Copenhagen. 8.40, H. V. Morton, "Off the Route."

Abroad.

Strasbourg, 8.30, Vienna Singing Boys and the Radio Orchestra.

WEDNESDAY MAY 5th.

Nat., 6.40, Recital of Folk Songs by Surya Sena (Sinhalese singer).
"The Fol-de-Rols. 9.20, "We Gave Our Grandmother."

Reg., 7.30, "The Hey-day of the Music Halls"—records. "Filson Young, "In Western Lands."

Abroad.

Radio Paris, 8.30, "The Black Domino," comic opera (Auber).

THURSDAY, MAY 6th.

Nat., 7.50, "Radio Rodeo" from the Union Cinema, Kingston. 10.20, The Theatre Orchestra and Mischa Motte (entertainer).

Reg., 8, Act I of Gluck's "Alceste" from Covent Garden. "Paradise Isle"; music of the South Seas.

Abroad.

Königsburg, 8, Puccini's "Madame Butterfly," conductor Brückner.



WHAT NEXT? Listeners to the National programme at 7.15 on Sunday will hear a Transatlantic contest in progress to discover the world's champion singing mouse. Aspirants from Canada, London, New York and Chicago will be taking part via the N.B.C. of America, the Canadian Broadcasting Commission and the B.B.C.

Radiolympia Girls. Harold Ramsay, Sidney Torch and Robinson Cleaver will be at the organ. The last variety show from Kingston was a great success, and listeners can be sure of a first-class entertainment.

OPERA

Home: From the Royal Opera House two opera excerpts will be heard this week. To-night (Friday) the first act of Puccini's "Turandot" will be relayed at 8 (Reg.). The scene of this act is by the walls of the Imperial Palace at Peking in legendary times. Eva Turner will appear in the title rôle, and the

SWING. For the next "Swing that Music" programme Kai Ewans and his orchestra will be heard from Copenhagen on Tuesday at 8 (Reg.). Two new Danish compositions will be heard for the first time. They are "The Girl I Knew" and "The Copenhagen Girl," the latter item has been composed specially for this occasion. The team which is considered the best swing band in Scandinavia plays at the Nimb Restaurant, Copenhagen, Kai Ewans is seen seated in the centre.

part of Calaf will be sung by Martinelli, who has not appeared at Covent Garden since 1914. The second relay comes to Regional listeners on Thursday at 8 when Act I of Gluck's "Alceste" will be heard, presented by a joint company of artistes from the Paris Opéra and Opéra-Comique. The action takes place in Greece in ancient times. This performance will be the only one of this opera during the present season.

Abroad: Budapest favours us again with the relay of the Royal Hungarian Opera programme at 7.30 to-night (Friday). The first item is a short opera, "The Love Letter," by Count Franz Esterházy, a member of the very distinguished Hungarian princely family. Although I have no data to hand about this particular composition, the record of this family is such as to make it certain that the theme of the opera is a national one.

Beromunster gives us a seldom-heard side of Hugo Wolf. "Der Corregidor," the only opera composed by this eminent writer of songs, is announced for its 8.50 programme to-night. Wolf actually commenced the composition of a second opera, but it was never finished.

Wolf-Ferrari's most successful opera has been chosen by Rome for its 9 o'clock programme on Saturday, his one-act "Suzanna's Secret" being relayed at that hour from the Teatro Massimo, Palermo. Hilversum completes Saturday's opera transmissions with a truly classical programme. At 10.25 Act III of Wagner's "Dusk of the Gods" will be heard, and an excellent performance may be expected, since the Wagner Association's

Choir and Concertgebouw Orchestra are responsible.

Frankfurt will give Puccini's "Tosca" at 8 on Sunday. This has long been a favourite of the English opera-goer. Its first Covent Garden performance was in 1900, the year of its Rome *première*.

Radio-Paris at 8.30 on Wednesday announces "The Black Domino," an opéra-comique of the typically French school composed by Auber, who resided in London for a number of years, and whose "Mesaniello"—the best known of his operas in this country—is reputed to have started the 1830 Brussels riots which drove the Dutch out of Belgium.

BOYS' ORCHESTRAS

THE regular Boys' Orchestra of the Norwegian Broadcasting organisation and the orchestra from the Drammen Grammar School combine to give a programme at 8.10 on Monday, which will be broadcast from all Norwegian stations. The programme will conclude with a choir of 400 boys uniting with the orchestras in a rendering of Strauss' "Blue Danube."

MISCELLANY

A RADIO Ball for the younger generation, which will consist of visits to many Copenhagen dance clubs, will be radiated from Kalundborg from 8.15 on Sunday until 2 a.m. on Monday.

Paris PTT is to broadcast a programme of folklore centred round Lille at 8.30 on Wednesday.

If ladies tune in to Leipzig at 8 on Wednesday, they are warned that they do so at their own risk, for a Stag party will be in progress.

THE AUDITOR.



"Distortionless" Driver

FOR AUDIO OUTPUT STAGE

By W. N. WEEDEN

AN interesting and important circuit application involving negative feed-back is the employment of such an amplifier to drive the grids of Class AB (quiescent pp) power output valves in high-quality amplifiers. Even though the valves in the output stage may be characterised by inherent low distortion performance, the amplifier output

unity, and should follow standard practice for the design of Class AB input, or driver, transformers, considering the effective output impedance in ohms in the cathode circuit to be approximately $1/g$. For a type 6C5 this value is 500 ohms. In series with the primary of the driver transformer is a resistance of the proper value to give a total cathode resistance which

Key to Lettering in Illustrations :

- a = I_{c1} = grid current
- b = I_{c2} = screen current
- c = total distortion
- d = 2nd harmonic distortion
- e = 3rd " "
- f = 5th " "
- g = 7th " "
- h = 9th " "
- k = 75 volts RMS
- m = 50 " "
- n = 25 " "
- p = 80 " "
- q = 55 " "
- r = 30 " "

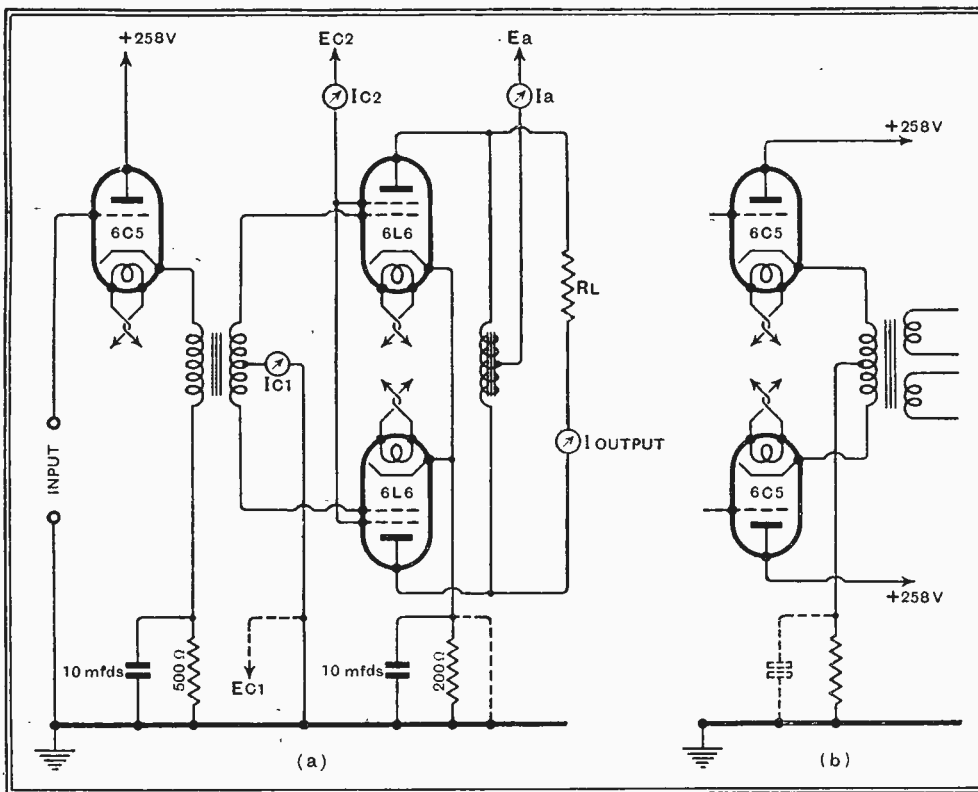

Fig. 1.—Distortion in a driver valve can be greatly reduced by adopting cathode coupling as shown at (a) for a single and at (b) for a push-pull driver stage.

may be seriously affected by distortion introduced by the driver stage. The data given here were supplied to the writer by the Hygrade Sylvania Corp. on a suitably degenerative AF amplifier employed to drive a pair of 6L6 valves in push-pull. The following curves show the performance which may be expected from such an AF system. Average production valves were employed in securing this data.

The circuit of Fig. 1(a) shows a conventional power output stage—from the secondary of its input transformer. The interesting feature, however, is the connection of the driver transformer in the cathode circuit of the driver valve, instead of in the conventional position in the anode circuit. This involves certain changes in transformer design. It has an overall turns ratio of slightly less than

will bias the grid by the correct amount. In this particular case the transformer primary has a DC resistance of 500 ohms, while 1,000 ohms is necessary to produce

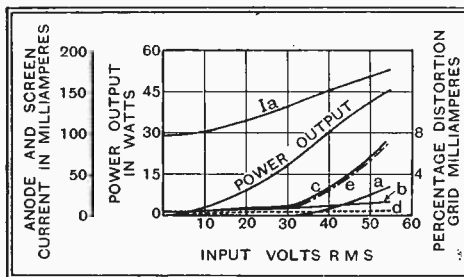

Fig. 2.—These curves show the performance of two 6L6 valves in push-pull with a 6C5 driver valve. The 6L6 valves have 400 volts anode and 250 volts screen supplies and a load impedance of 7,500 ohms.

eight volts of bias with 258 volts on the 6C5 anode, and 8 mA. anode current. Thus a 500-ohm resistance, thoroughly by-passed, is placed in series with the 500-ohm primary of the input transformer. This resistance varies, of course, with both the valve and transformer used.

As pointed out by Cocking, degeneration decreases the gain of a stage in which it is present. Therefore, the signal input to the driver grid must be much larger than with the input transformer connected normally. However, the very low inherent distortion and low output impedance characterised by this arrangement contribute to a marked improvement in overall performance.

Figs. 2 and 3 show operation characteristics with self-bias on the output valves, under two standard operating conditions for the 6L6 valves. Anode, screen and input grid currents, power output and distortion are shown as functions of the

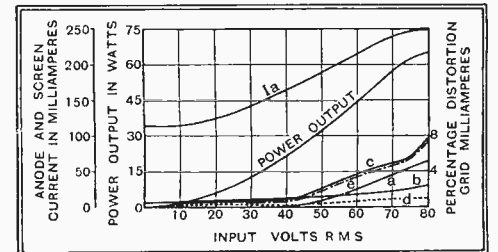

Fig. 3.—These curves are similar to those of Fig. 2, but are for the case when the 6L6 valves have screen potentials of 300 volts. The optimum load is then 5,500 ohms.

RMS signal to the driver grid. In Fig. 3 the 6C5 driver begins to draw grid current at an input of approximately 75 volts.

Similar data are given in Figs. 4 and 5 except that the output valves are operated with fixed-bias. The driver conditions were the same as above.

The load resistance employed in each case was different. The optimum loads which were chosen were obtained from the output characteristics given in Figs. 6 and 7. Power output and distortion readings

"Distortionless" Driver for Audio Output Stage
 were taken for three different values of input signals, as the load was varied. Small deviations from the load values selected may be desirable, depending on the power level at which the amplifier is worked. The effects of load changes are

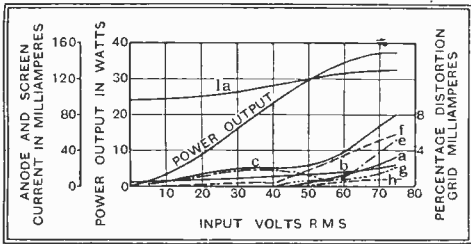

Fig. 4. These curves are again like those of Fig. 2, but here a fixed grid bias of -20 volts is used for the output valves. The load is 6,000 ohms.

clearly indicated and the choice will be governed by the individual requirements.

The circuit shown indicates that the 6L6 output valves are operating as high impedance pentodes, which is not desirable from the point of view of speaker damping and transient reproduction. To secure best results from this point of view, it is almost essential to apply negative feed-back to the output stage both in order to decrease harmonic distortion, and to reduce the effective anode resistance of

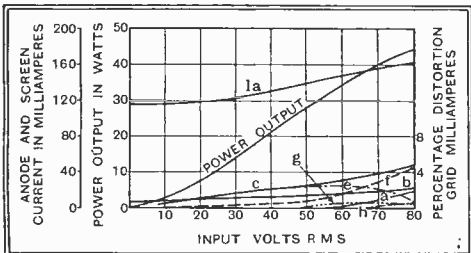

Fig. 5.—In this illustration the conditions for the 6L6 valves are the same as in Fig. 3, but fixed bias of -25 volts is used. The load is 3,800 ohms.

the 6L6s so that the speaker looks back into a low resistance, thus securing the same damping that would be secured with low-resistance triodes. Unfortunately, this use of degeneration decreases the power sensitivity, so that from twice to four times the input or signal voltage is required for a given output. Due to the loss of gain in the driver, the 6C5 is already being worked to its limit, consequently the use of either a push-pull driver arrangement, as shown in the diagram Fig. 1b, or one of the small power

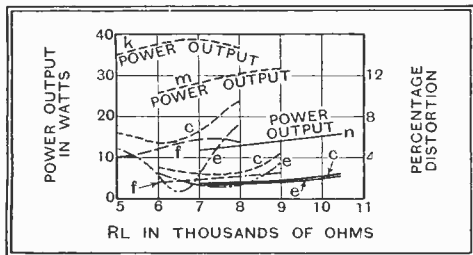

Fig. 6.—The effect of the load impedance RL for the conditions of Fig. 2 is shown here for various signal inputs.

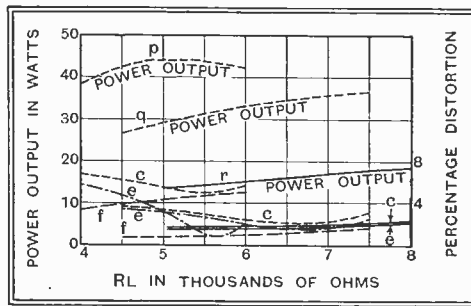

Fig. 7.—Here again the load impedance is the variable factor, but the screen potential is now 300 volts.

output triodes, or two of them in push-pull, will be required in order to supply the increased grid voltage of the 6L6s.

Television Programmes

Transmission times are from 3-4 and 9-10 daily.

Vision 45 Mc/s. Sound 41.5 Mc/s.

FRIDAY, APRIL 30th.

3, Esther Coleman—Songs. 3.10, Artists and their work; drawings by James Thurber of "The New Yorker." 3.20, British Movietonews. 3.30, Sports Review: Howard Marshall makes his first television appearance interviewing sporting personalities of the month. 3.50, Starlight—Leonard Henry. 9, Eric Wild and his Tea-Timers. 9.10, Repetition of 3.10 programme. 9.25, Gaumont-British News. 9.35, Repetition of 3.30 programme. 9.50, Starlight—Cornelia Otis Skinner.

SATURDAY, MAY 1st.

3, Summer Gardening: Demonstration by C. H. Middleton on a garden bed in the grounds of Alexandra Palace. 3.15, Herschel Henlere at the piano. 3.25, Gaumont-British News. 3.35, Alice in Wonderland adapted for television with Ursula Hanray as Alice. 9, "Fugue for four cameras," danced by Maude Lloyd. This programme will show the interesting effects made possible by using four television cameras. 9.10, Summer Gardening: Studio talk by C. H. Middleton. 9.25, British Movietonews. 9.35, "The Mizzen Cross-trees." Nautical songs and dances.

MONDAY, MAY 3rd.

3, Fashion Parade. 3.15, Billiards demonstration by Joe Davis and Tom Newman, finalists in the United Kingdom Professional Billiards Championship. 3.25, Gaumont-British News. 3.35, The Vic-Wells Ballet in "Les Patineurs." 9 and 9.15, Repetition of 3 and 3.15 programmes. 9.25, British Movietonews. 9.35, Repetition of 3.25 programme.

TUESDAY, MAY 4th.

3, Health Exercises by members of the Women's League of Health and Beauty. 3.25, "The 'ole in the Road": sketch by Seamark, with George Graves and Myles Clifton. 3.40, British Movietonews. 3.50, Starlight—The Western Brothers. 9, Personalities II. 9.10, Cascade; a mixed programme. 9.25, Gaumont-British News. 9.35, Ballroom Dancing; Alex Moore and Pat Kilpatrick. 9.50, Starlight.

WEDNESDAY, MAY 5th.

3, Charlot Starlets. 3.20, Gaumont-British News. 3.30, Fifty-first Picture Page. 9, Repetition of 3 programme. 9.20, British Movietonews. 9.30, Fifty-second Picture Page

THURSDAY, MAY 6th.

3, Wynne Ajello—Songs. 3.10, Architecture—III. 3.25, British Movietonews. 3.35, Television production of John Drinkwater's "Abraham Lincoln." 9, Instrumental item. 9.5, Repetition of 3.10 programme. 9.20, Gaumont-British News. 9.30, Cabaret, including Hildegard.

MCCARTHY

6-valve all-wave Superhet with Radio Frequency Stage

8 stages.
8 tuned circuits.
3 wavebands.

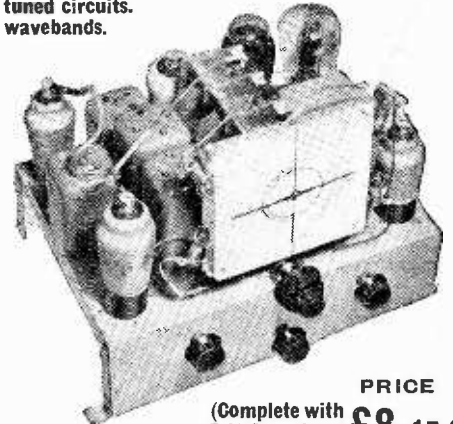

PRICE
 (Complete with B.V.A. valves) **£8.17.6**

Performance (made possible by use of multi-electrode valves) equal to that of many receivers employing 8 valves or more. Brief specification includes: Large "Airplane" dial, with different coloured lights automatically switched on for each wave-range. Micro-vernier 2-speed drive. 4-point wave-change and gramophone switch. Volume control and variable tone control also operative on gramophone. Reinforced heavy-gauge steel chassis. Covers 19-2,000 metres. Circuit comprises: Preselector circuit, radio frequency amplifier (operative on all 3 wavebands), triode-hexode frequency changer, double band-pass I.F.T. coupled I.F. amplifier, double diode-triode detector and L.F. amplifier. D.A.V.C. applied to 3 preceding valves. 3-watt pentode output.

Special

6-VALVE BAND-PASS SUPERHETERODYNE



£7 (Complete with B.V.A. Valves.)

Specially designed and built for high quality radio gram work. **SPECIAL FEATURES:** Reinforced stout steel chassis. High class components by well-known makers of acknowledged reputation used throughout. Fitted with attractive and specially large full-vision dial, glass fronted, and supplied complete with escutcheon and fittings. Separate illumination automatically switched in for radio gramophone. **CIRCUIT DETAILS:** Inductively coupled band-pass filter, triode-hexode frequency changer, band-pass I.F.T. coupled I.F. amplifier, I.F.T. coupled to diode detector. D.A.V.C. applied to preceding valves. L.F. amplifier capacity coupled to output pentode 3-3½ watts undistorted. Variable tone control and volume control operate on both radio and gramophone.

ALTERNATIVE TRIODE OUTPUT
 All McCarthy receivers supplied complete with valves, knobs, pilot lamps, leads, mains cable and plug. 12 months' guarantee. Deferred terms on application, or through London Radio Supply Co., 11, Oat Lane, E.C.2. Cash with order on 7 days' approval. Also write for illustrated catalogue of complete range of all McCarthy receivers.

MCCARTHY RADIO LTD.
 44a, Westbourne Grove, London, W.2
 Telephone: Bayswater 3201/2.

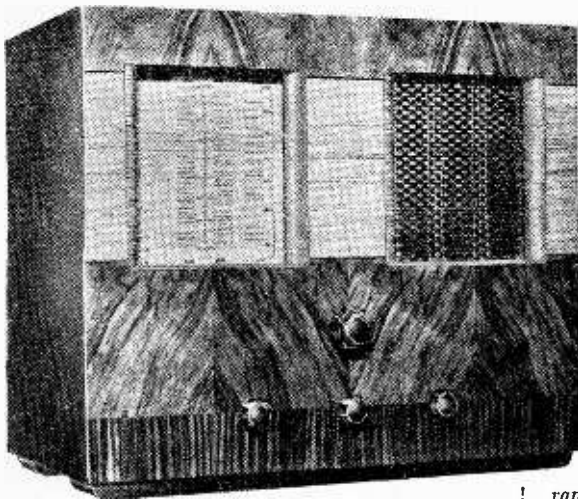

Marconiphone

MODEL 222

A Sensitive Battery Superheterodyne with Three Waveranges

FEATURES. *Type.*—Table model superheterodyne for operation from batteries. **Waveranges.**—(1) 18-50 metres. (2) 195-580 metres. (3) 840-2,000 metres. **Circuit.**—Heptode frequency-changer—var.-mu screen-grid IF amplifier.—double-diode-triode second detector—double pentode output valve. **Controls.**—(1) Tuning. (2) Volume and on-off switch. (3) Waverange. (4) Tone. **Price.**—13 guineas. **Makers.**—Marconiphone Co., Ltd, 210/212, Tottenham Court Road, London, W.1

THIS receiver, which is the leading model in the Marconiphone series of battery sets, is notable alike for its good performance in the matter of sensitivity and for many neat features in its design and construction. The four-valve superheterodyne circuit includes a QPP output stage, which is acknowledged to give a very high standard of volume and quality for a small expenditure of HT battery current, and there are many refinements in the earlier stages which contribute materially to the efficiency and smooth working of the receiver.

There are two aerial tappings, one of which incorporates a series resistance for use with large aerials or when situated near to a powerful transmitting station. The coupling is through a single tuned circuit on the short waves and through a band-pass filter, with top- and bottom-end capacity coupling, on medium and long waves. Across the aerial and earth circuit is connected an IF filter, and an unusual refinement is the provision of a subsidiary "dummy" coupling coil in association with the secondary circuit to

simulate the aerial loading and thus to enable more accurate alignment of the circuits throughout the range.

The heptode frequency-changer has separate oscillator circuits for each waveband, and the oscillator anode voltage is increased on the short-wave range. Litz-wound IF transformers tuned to 465 kc/s are associated with the IF amplifier, which is a variable-mu screen-grid valve instead of the usual pentode. The output IF transformer is tapped down both on primary and secondary windings to feed the AVC and signal diodes respectively. A suitable delay is obtained by returning the AVC diode load to 1.5 v. negative, and a small additional bias is also gained by virtue of the fact that the AVC diode is situated near the positive end of the filament.

Both the frequency-changer and the IF valve are controlled, and the circuit is arranged to keep a small initial bias on both valves. The output from the signal diode is taken through a volume control

potentiometer to the triode amplifying section of the second detector stage, and the circuit is arranged so that the input from the gramophone pick-up is also introduced at this point through the same volume control. The push-pull transformer preceding the QPP output valve is resistance-capacity fed from the triode.

A small but efficient permanent-magnet loud speaker takes the output from the QPP stage and gives quality and volume of reproduction which would put to shame many receivers operating under the advantage of a mains supply. There is a three-stage tone control, which can, in general, be left in the high position on all wavebands, owing to the low level of background noise. The bass response is good and there is just the right amount of top to give well-balanced reproduction—this in spite of the high selectivity. On long waves we have seldom before had such clear reception from the Deutschlandsender with so little interference from Droitwich and Radio-Paris, and on the medium-wave band with the aerial connected to the A2 tapping it was found possible to approach to within less than one channel on either side of the Brookmans Park transmitters at a distance of fifteen miles before signs of interference showed themselves.

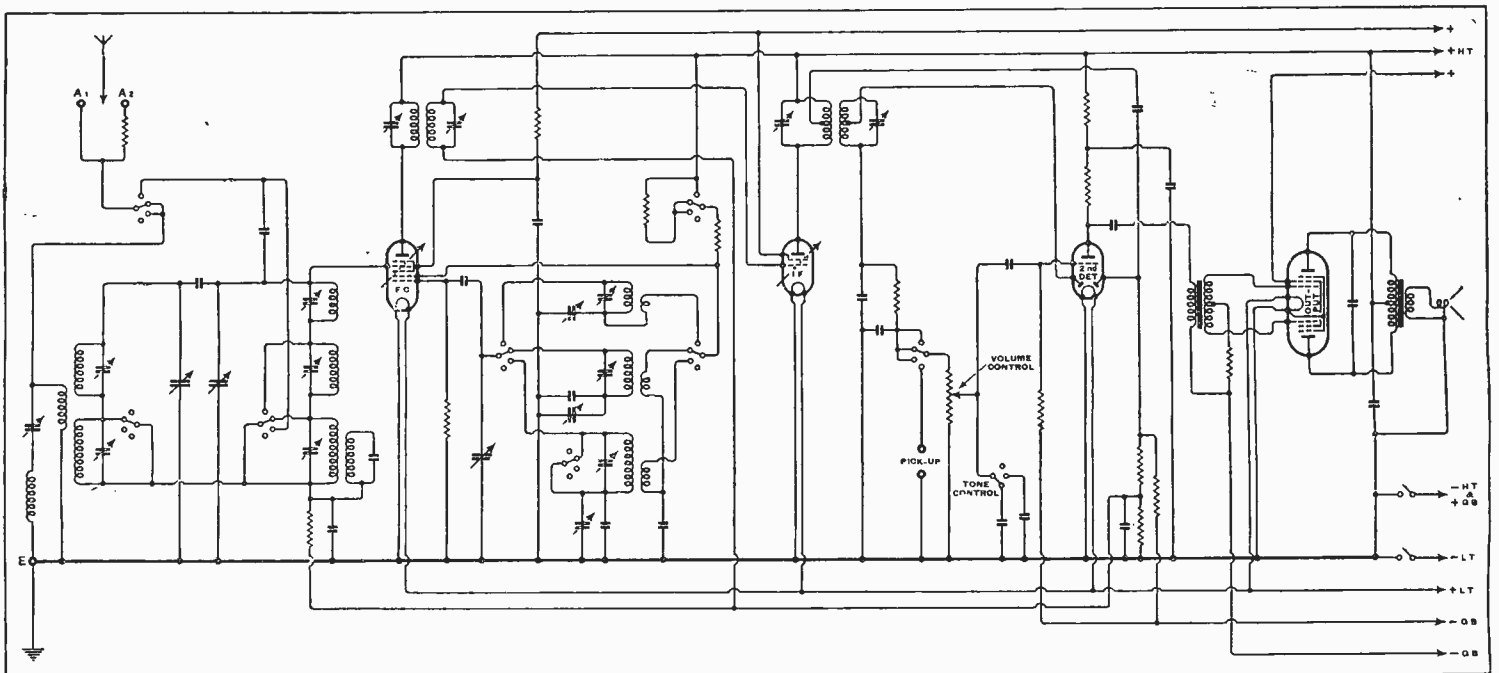

An unusual feature of the circuit is the provision of a balancing circuit in association with the band-pass filter secondary to ensure constant alignment.

The excellent effective range and sensitivity of the Model 222 is undoubtedly due to some extent to the low level of background noise, which on the short-wave range at first aroused suspicions of comparatively low sensitivity. This impression was soon dispelled, however, when Schenectady (W2XAD) was picked up and held for upwards of an hour during the late afternoon. It is only fair to say that, while many of the European transmissions were easily located by virtue of their higher field strength, the American station was at first overlooked, and we put this down to the fact that the slow-motion drive might with advantage have been given a somewhat higher ratio. However, when the feel of the controls has been acquired, tuning on short waves presents little difficulty.

An unusually large and well-set-out tuning scale has been provided in which

panel of the cabinet has been constructed with a suitable recess so that the LT accumulator can be removed for charging without having to remove the panel.

Measurements on the HT consumption indicated that the standing current with no signal on the aerial—i.e., with the first two valves working at maximum sensitivity—was 8.5 mA. The unmodulated carrier of the local station reduced the HT to 5.5 mA, and, although it is difficult to estimate the average current under normal working conditions, it would not be far wrong to put this at 8 to 9 mA for the best compromise between volume and quality on an orchestral transmission.

The efficient working of the QPP stage is at all times dependent on careful adjustment of the auxiliary supply voltages in relation to the maximum HT voltage, and the makers' instructions should be followed implicitly. There is no pro-

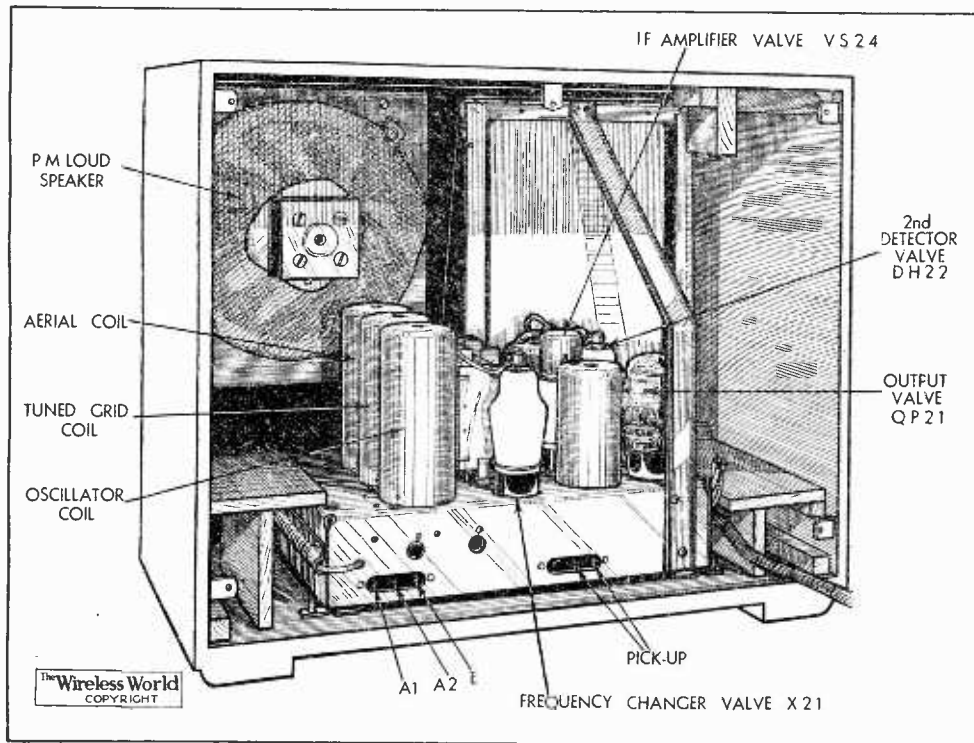

Interior of cabinet, showing offset tuning scale and shelves for HT and LT batteries.

the three waveranges are calibrated on vertical scales. The indicator takes the form of a horizontal hair line on a strip of celluloid which moves up and down the scale very much after the style of a slide rule cursor. Station names are indicated on the medium- and long-wave scales, and the principal broadcast bands have been marked on the short-wave scale. At the bottom of the panel is a small circular window with a pilot light which shows when the set is in operation. The rectangular tuning scale is matched by a loud speaker grille of similar size and shape, which is faced with the "sound-permeable" metal grille which is a feature of this firm's products.

The chassis is mounted centrally in the cabinet, and the tuning scale is offset, being supported rigidly by a channel-section bracket. Strong shelves are provided at each side of the chassis for the HT and LT batteries, and the fibre back

vision for an external loud speaker, but the set can be used for the reproduction of gramophone records, for which an ample reserve of amplification is provided.

"Stentorian" Extension Speakers

HITHERTO all the loud speakers in the "Stentorian" range made by Whiteley Electrical Radio, Ltd., have been fitted with "Microlode" universal matching transformers which make them suitable for use with sets requiring output loads of either high or low impedance.

As nowadays a very large percentage of commercial receivers call for a low impedance load it has been decided to issue the standard cabinet models without transformer if desired, and at a proportionately reduced price. A speech coil impedance of 2 ohms has been standardised, and those speakers which have been designed to work with the "Long Arm" remote control unit will not be affected.

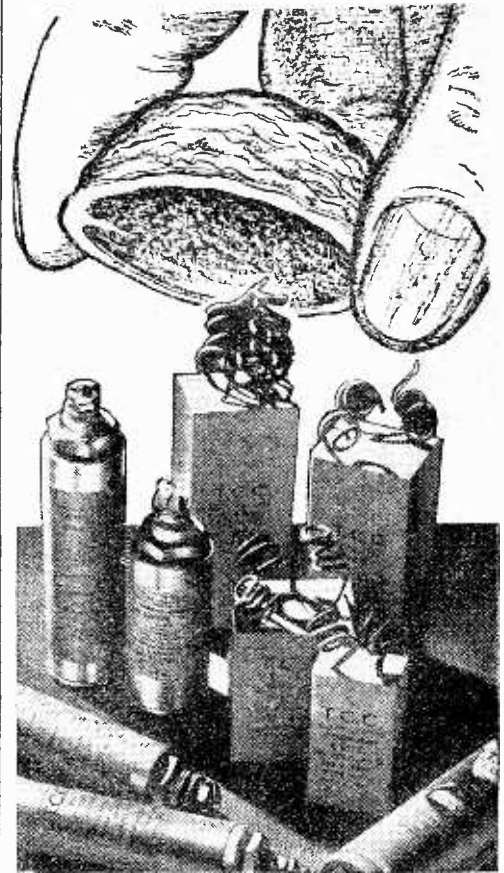

You must
LOOK UNDER THE SHELL WHEN JUDGING A CONDENSER

One condenser may look like another, but appearance does not make performance. So look under the shell—investigate what gives the performance, and how.

Strip open any T.C.C. condenser—see the "finish" inside. Take the paper type... see the purest linen tissue, that not only stands up to heavy flash tests but lasts a lifetime. See too, the finest foil, so carefully positioned... Note the heavy soundly soldered leads that connect the tags... fine workmanship all of it. A pity you cannot see the 28 years' specialized research that has led up to the design of these condensers. But you can accept the verdict of the country's leading set makers, they are prepared to take T.C.C. condensers on trust. Why? Because they have never been let down... For safety's sake use T.C.C.

T.C.C.
ALL-BRITISH
CONDENSERS

The Telegraph Condenser Co. Ltd., Wales Farm Road, N. Acton, W.3.

RANDOM RADIATIONS

By "DIALLIST"

Coronation Figures

IT'S rather interesting to figure out what wireless users are going to spend on current during the Coronation Week celebrations. A conservative estimate of the number of sets in the country is 9,000,000, divided into 4,500,000 mains receivers, 4,000,000 battery and 500,000 crystal. Not every one of them, of course, will be at work during the week, but we shan't be far out in estimating 135,000,000 hours of listening in the seven days with mains sets and 120,000,000 with battery sets. If we assess the average mains set at 60 watts, this comes to 8,100,000 units, or a total expenditure, allowing threepence a unit, of £100,000 in round figures. Not so bad for the mains sets! And what of the rest? The crystal receivers we can leave out of our reckoning, for they have at any rate one advantage; they cost nothing to run. But battery sets account for a big sum.

The Cost of Watts

To arrive at the average watt-hour demands of the battery set is not quite so easy as for its main opposite number. Battery sets range from the tiny affair with a couple of valves, drawing perhaps 0.25 ampere at 2 volts from the LT accumulator and 5-6 milliamperes at anything down to 50 volts from the HTB, to the seven-valve superhet with an LT load of over an ampere and an HT load of 25-30 milliamperes at 150 volts. Probably a fair average estimate would be 0.4 ampere at 2 volts, or 0.8 watt LT and 10 milliamperes at 100 volts, or 1.0 watt HT. Taking it that a 2-volt 30-ampere-hour accumulator costs sixpence for a charge, we have 10 watt-hours for a penny. The price per unit of LT current is thus 8s. 4d., or, say, eight shillings in those round figures that are so much less trouble than the other sort. High-tension current is not simple to cost out. Some people use accumulators, and these may spend little more per unit on HT than on LT supplies, depreciation and so on being left out of account in both instances.

An Amazing Total

At the other end of the scale are those who rely on hopelessly overloaded small-capacity dry HTB's. Their HT current may cost them the best (or worst!) part of a couple of pounds per unit. Taking it by and large, 15s. per HT unit is probably well within the mark for battery supplies of all kinds. With the 120,000,000 hours of work allotted to them during Coronation Week, battery sets will thus require 96,000 units at 8s. for their LT circuits, with a value of over £38,000, and 120,000 units at 15s., or £90,000 worth, for their HT circuits. Adding together the £100,000 for mains sets and £128,000 for battery sets, we arrive at a total of £228,000. The figures err, if anything, on the low side; the total expenditure on current for wireless sets probably won't be very much under a quarter of a million pounds. It seems a lot at first sight—until you realise that it means less than sevenpence per set, or perhaps twopence per listener, for a whole week of "gala" entertainment.

Be Prepared

ONLY eight days remain now till Coronation Week begins with its wonderful programmes and historic running commentaries. This is just the gentlest of reminders that should there be an if or a but about your set it may be as well to see to it or have it seen to at once, ere wireless shops run out of stock of the things that you must have and service men become harder to get hold of than admirals in Switzerland. That valve with the loose cap, of which the connections are, so to speak, hanging on by their eyelashes; that wave-change switch with the contacts that have been getting chancier and chancier for weeks; those spare fuses that you have been meaning to buy since heaven knows when; that HTB that is crying out for renewal—all these and others like them are things that let you down if they're not seen to just at the critical moment. Then go to it, my hearties, without more of that procrastination that is dear to most of us. And I only hope I myself will remember to renew the ancient earth wire that is down to about its last sound strand!

Television in the Country

HALF an hour before writing this note a neighbour of mine was showing me and letting me hear what the television set that he has recently installed can do. This is the first time that I have seen television reception outside London, and I must say that I was agreeably surprised to find both sound and vision excellent. This locality is just over 20 miles as the crow flies from the Alexandra Palace, and according to the B.B.C.'s field-strength map, it lies only a little way inside the 0.5 millivolt-per-metre contour. It would seem that 1 millivolt per metre is by no means the minimum field strength for good reception, for we had a rock-steady image all the time with fine contrasts and excellent definition. The only

Portable Receiver in a Camera Case

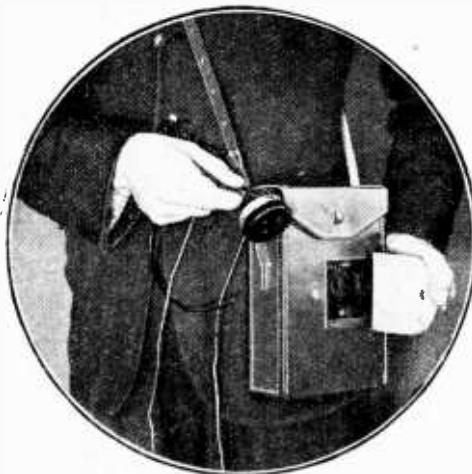

When closed up the "Pocketphone" portable, fuller particulars of which are given on the opposite page, might easily be mistaken for a camera.

trouble experienced at all was from passing motor vehicles; as I anticipated, it has so far proved a bit of a problem to get the aerial high enough to be outside the zone of ignition interference. But even though there was a good deal of traffic going right past the windows of the room in which the set stands, the interference was seldom severe enough to spoil reception for more than a second or two.

Pill for the B.B.C.

SIR THOMAS BEECHAM, I observe, has been getting it off his chest again. He objects to the B.B.C.'s sending out what he describes as the biggest nonsense ever heard in music for three-quarters of the day. His only consolation is that "such musical toys as the wireless and the gramophone" have a very short life, by which I take it he means that both broadcasting and the making of gramophone records will pass ere long into the limbo of forgotten things. That both will eventually be superseded by something far superior to what we have now I haven't the smallest doubt, but they're going to develop—possibly in amazing ways—and not to fade out. Sir Thomas forgets, I think, the enormous debt that music owes to both. But for the record and the loud-speaker millions of folk would never have heard Caruso or Melba or Mischa Elman or Mark Hambourg; opera would have been unknown to them—and so would the conducting of Sir Thomas Beecham. He mustn't grudge us the musical nonsense that many of us find so diverting at times. Serious music from early morn to midnight would be a little indigestible.

Peccavi!

A CORRESPONDENT castigates me for having written in a recent paragraph of "the now almost traditional three-valve-plus-rectifier superhet." He has been to the trouble of analysing the particulars of 288 mains-operated superhets made by 30 different firms, and finds that only 32 of these are of the three-valve type. *Peccavi!* 'Twas a slip of the pen; I should have written—did indeed mean to write—"three or four valves." Be it noted, too, that I was referring to the moderately priced set and not to that which costs from £15 upwards as an "all-wave" receiver. I am very glad to have my correspondent's figures; I hadn't made such a careful analysis myself, but was writing rather from the general impression gained as a result of examining and trying out the biggest selection of sets sent along to me this season.

Another Explosion

A WEEK or two ago I told how a gassing accumulator had resolved itself into powdered glass and a shower of dilute sulphuric acid when a naked light was thoughtlessly brought near it. A correspondent who does a good deal of charging tells me that he has known the same thing happen through a loose connection in a line of batteries on charge. His footsteps shook the bench on which they stood as he was passing; there was a spark, a flash and one accumulator less on the line. Those who do their charging at home might do well to bear this in mind. The accumulator cell is a perfectly safe thing so long as you treat it with ordinary care. But when it is gassing it gives off hydrogen, and a mixture of hydrogen and air can explode with surprising violence if ignited.

THE POCKETPHONE A Portable Receiver in a Camera Case

AS a result of a recent paragraph by "Free Grid" on the subject of portable sets for use on the route of the Coronation procession we have received for test from A. Reid Manufacturing Co., Ltd., 14a, Clerkenwell Green, London, E.C.1, a neat little receiver costing £3 19s. 6d., which seems to conform exactly to the specification which was envisaged.

The leather carrying case measures only 8½ in. by 6 in. by 2½ in., and is provided with a strap so that the set can be slung across the shoulders, leaving both hands free. Access to the controls is gained through a flap which when shut automatically switches off the set.

A three-valve circuit is employed, and an interesting feature is the use of resistance

coupling for the RF amplifying stage. The frame aerial is wound round the inside of the case and is tuned to cover the usual medium-wave band.

Tested in London adjacent to the Coronation route excellent reception was obtained from the two Brookmans Park stations and the volume was sufficient to give intelligible speech above the traffic noise. On the local stations tuning is by no means critical, and with a little care it was found possible to bring in Fécamp, though a quiet corner would be necessary for the proper enjoyment of this station's programme out of doors.

The set is little heavier than a pair of binoculars, and there can be no doubt that it forms a valuable addition to the impedimenta of the sightseer.

IN NEXT WEEK'S ISSUE

Three-valve Battery Set for the Experimenter

5-15 Metre
Reception

Investigating receiving conditions prevailing from time to time will provide a new interest for the amateur experimenter. The receiver for this purpose need not be complicated or elaborate, and quite a simple set will suffice provided it is correctly designed.

In this article an inexpensive yet efficient receiver for use on these very high frequencies will be described. It includes three valves and is battery-operated.

LIST OF PARTS.

Certain components of other makes but of similar characteristics may be used as alternatives to those given in the following list.

Condensers:		
Variable		
2 40 mmfds.	Eddystone "Microdenser" 900/40	
1 20 mmfds.	Eddystone "Microdenser" 900/20	
1 30 mmfds. mica	Eddystone 1023	
Fixed		
1 0.00005 mfd. mica	Hunt's 1121	
1 0.01 mfd. non-inductive, tubular	Dubilier 4401	
1 2 mfd. 700 volts test	Wego	
Dial, slow motion	Utility "Micro-dial" W181	
Flexible coupler	Bulgin EH12	
Resistance, 5 megohms, ½ watt	Dubilier	
2 Section-wound SW chokes	Denco	
2 Small RF 'phone chokes	Denco	
1 Set of 6 coils (3 ranges) and 2 bases	Denco	
	1 Switch, QMB on/off	Bulgin S80
	1 Transcoupler	Bulgin LF10
	2 Valve holders, 4-pin	Eddystone "Frequentite" 949
	1 Valve holder, 5-pin	W.B. Rigid Type
	1 Battery cable, 5-way	Bulgin BC3
	4 Terminals	Ealex
	5 Wander plugs	Ealex
	2 Spade ends	Ealex
	2 Plug-top valve connectors	Belling-Lee 1175
	1 Grid Bias battery, 9 volts	
	1 Knob for reaction condenser	Bulgin K44
	Plymax base, 7×8×¾ in.	Peto-Scott
	Aluminium panel 7×8½ in. and 2 brackets for RF condenser and detector valve holder	
	Miscellaneous:	Peto-Scott
	Small quantity wire, screws, nuts, bolts, ebonite strip 7×1½×¾ in., two small panel brackets, etc.	
	Valves:	Hivac
	1 SG220SW, 1 D210SW, 1 Y220.	

NOTABLE FEATURES of the *New* ROLA F742-PM

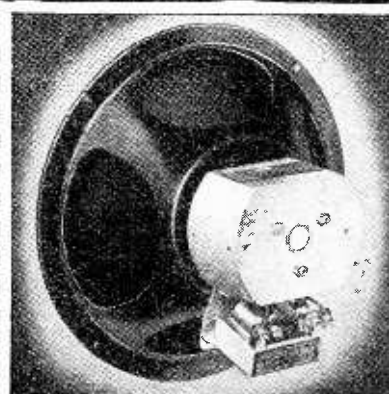

A NEW ROLA MODEL OF SUPER SENSITIVITY

Specially introduced to meet the demand for a highly sensitive permanent magnet speaker of smaller size and lower price than the famous G.12-PM, the new Rola F742-PM is unquestionably the finest 9½" diameter speaker you can obtain. The flux density in the air gap is 11,500 lines per square centimetre, the same as with the G.12-PM, rendering this new unit particularly suitable for use with battery sets or as an Extension Speaker. The F742-PM makes use of the new magnet material "Alnico," and another noteworthy feature is the special metal and compound shielded universal transformer which is impervious to moisture.

Write to-day for leaflet AB.



WITHOUT TRANSFORMER 42/-
OVER 8 MILLION IN USE

ROLA

The World's Finest Reproducers

THE BRITISH ROLA CO., LTD.
MINERVA ROAD, PARK ROYAL, N.W.10.
PHONE: WILLESDEN 4322-3-4-5-6

Recent Inventions

GENERATING SYNCHRONISING SIGNALS

IN modern high-definition television, the apertures in the scanning disc are only 0.002 in. in diameter. If the synchronising impulses are to be accurate, the leading edge of the generating slots must be correctly set to within a distance of the same order. As this is not possible in practice, instead of the proper frequency, there appears a complex frequency containing components of the order of the rotation of the disc. These must then be passed through a band-pass filter, followed by a non-linear amplifier.

According to the invention accurately-timed impulses are obtained by piercing the scanning-disc with circular holes, spaced apart at distances equal to their diameter. The fixed slit which determines the cross-section of the beam of light, across which the holes travel, is also made of equal diameter. This results in the production of a sinusoidal variation of light, which can be directly and simply converted into synchronising impulses of the required form.

The General Electric Co., Ltd., and D. C. Espley. Application date November 22nd, 1935. No. 458883.

CATHODE-RAY TUBES

VOLTAGE to be measured is applied from a source O to the grid of a valve V, the anode inductance L of which is coupled to the modulating-electrode E of a cathode-ray tube. The potential across L is then proportional to the rate of change of the applied voltage, and the coupling with E is such that an increase in the rate-of-change causes a more positive voltage to be applied, and, therefore, produces a larger ionic content of the electron stream.

In other words, the spot tends to be brightest when it is moving at its highest speed across the screen, thus offsetting the otherwise poor fluorescent response due to its transverse velocity.

R. A. Watson Watt. Application date March 26th, 1935. No. 459041.

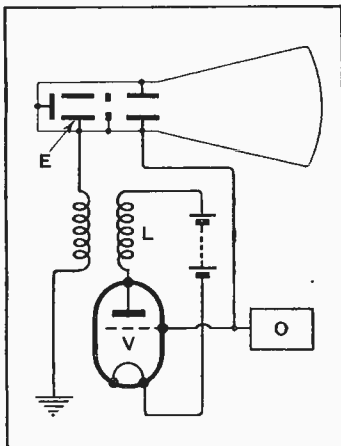

Arrangement of the apparatus described in Patent No. 459041.

ELIMINATING INTERFERENCE

TO cut out interference, the dipole aerial A is coupled to the input of the first valve V through a transmission line T, which terminates in two balanced circuits L, C and L₁, C₁. Any inductive pick-up along the line T is thus balanced out, instead of being transferred to the input coupling L₂, L₃. The balance is made more effective by means of a differential condenser C₂ and variable resistance R.

Adjustment of the resistance R damps one or other of the tuned circuits until the fields due to interference currents cancel out. Adjustment of the differential condenser C₂ detunes the circuits L, C and L₁, C₁ to such a degree as to enable the phase of the interfering currents to be accurately opposed. One adjustment may slightly affect the other, but it is

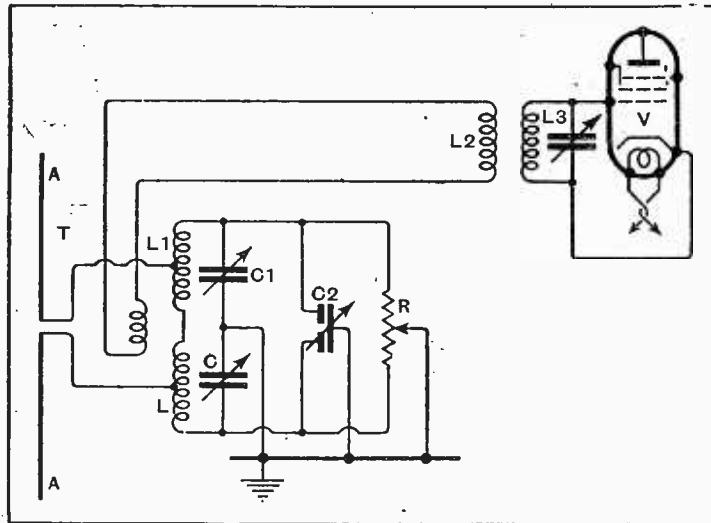

Anti-interference system using a balanced input circuit.

always possible to arrive at a stage when the signals come through free from any noise.

Kolster Brandes, Ltd., and C. W. Earp. Application date June 28th, 1935. No. 458801.

HIGH-FREQUENCY "CONDUCTORS"

IT is pointed out that for high-frequency work conductors having a continuous surface (a) possess considerable inductance and (b) give rise to eddy-current loss. The inventor, therefore, uses a "composite" material, having a dielectric such as colloidal graphite as base, but containing a high proportion of metallic powder, both magnetic and non-magnetic.

The conductive particles act in much the same way as a large number of condensers arranged in series and in parallel, and so ensure a substantially-uniform distribution of capacity throughout the body of the material. For very high frequencies, the net effect is not substantially different from that of ordinary conduction. The material is particularly useful in high-frequency therapy. It

Brief descriptions of the more interesting radio devices and improvements issued as patents will be included in this section

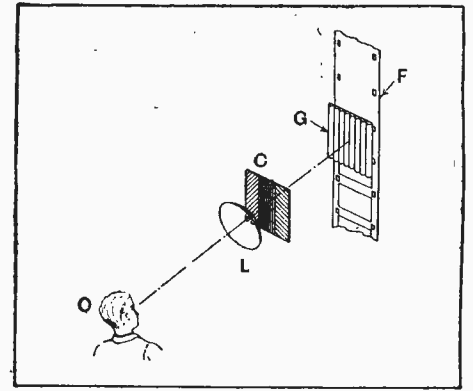

Optical system for televising in natural colours.

can also be moulded into rods or tubes for making tuning coils, leads, etc.

F. K. Nagelschmidt. Application date April 17th, 1935. No. 458505.

TELEVISION IN COLOURS

COLOUR effects are obtained by passing the light from the object O through a lenticular grating G before it falls on to a photo-

where they are reproduced as a "replica" film. This is finally projected on to a viewing screen through a "reversed" optical system, and appears in natural colours. By substituting a double lens for that shown at L, a stereoscopic effect can be obtained.

Baird Television, Ltd.; T. M. C. Lance; and E. H. Foden-Pattinson. Application date June 27th, 1935. No. 458791.

AERODROME SIGNALS

AT an aerodrome it is usual to provide both visual signals, such as Neon lamps, and wireless transmitting equipment. According to the invention, instead of using a separate source of supply, both the lamps and the wireless transmitter are energised from the same high-frequency source, which may be a valve generator. Amongst other advantages, this allows Morse code signals to be superposed on the light from the lamps, as well as on the wireless transmitters, reception in the former case being effected by means of photo-electric cells. The system can also be used for communicating from aeroplane to aerodrome, or from aeroplane to aeroplane, by light signals when flying in close formation, and by wireless over longer distances or in fog.

J. Fodor. Application date March 16th, 1935. No. 458307.

SOUND AND PICTURE RECEIVERS

THE local oscillator of a super-het. receiver produces two beat frequencies, one for the sound and the other for the picture signals. As both beats occur close together in the frequency range, they are fed, according to the invention, to a common IF amplifier. This comprises several resistance-capacity-coupled stages, which are neutralised to prevent loss of the higher frequencies.

The sound and picture signals are separated out in the last stage of the common IF amplifier. They are then applied to independent detectors and are amplified along separate channels.

The British Thomson-Houston Co., Ltd.; T. H. Kinman; and D. S. Watson. Application date June 26th, 1935. No. 459070.

The British abstracts published here are prepared, with the permission of the Controller of H.M. Stationery Office, from Specifications obtainable at the Patent Office, 25, Southampton Buildings, London, W.C.2, price 1/- each. A selection of patents issued in U.S.A. is also included.

MISCELLANEOUS ADVERTISEMENTS

NOTICES

THE CHARGE FOR ADVERTISEMENTS in these columns is

12 words or less, 3/- and 3d. for every additional word.

Each paragraph is charged separately and name and address must be counted.

SERIES DISCOUNTS are allowed to Trade Advertisers as follows on orders for consecutive insertions, provided a contract is placed in advance, and in the absence of fresh instructions the entire "copy" is repeated from the previous issue: 13 consecutive insertions 5%; 26 consecutive, 10%; 52 consecutive, 15%.

ADVERTISEMENTS for these columns are accepted up to FIRST POST on MONDAY MORNING (previous to date of issue) at the Head Offices of "The Wireless World," Dorset House, Stamford Street, London, S.E.1, or on SATURDAY MORNING at the Branch Offices, 19, Hertford Street, Coventry; Guildhall Buildings, Navigation Street, Birmingham, 2; 280, Deansgate, Manchester, 3; 26a, Renfield Street, Glasgow, C.2.

Advertisements that arrive too late for a particular issue will automatically be inserted in the following issue unless accompanied by instructions to the contrary. All advertisements in this section must be strictly prepaid.

The proprietors retain the right to refuse or withdraw advertisements at their discretion.

Postal Orders and Cheques sent in payment for advertisements should be made payable to ILIFFE & SONS Ltd., and crossed *& Co.* Notes being untraceable if lost in transit should not be sent as remittances.

All letters relating to advertisements should quote the number which is printed at the end of each advertisement and the date of the issue in which it appeared.

The proprietors are not responsible for clerical or printers' errors, although every care is taken to avoid mistakes.

NEW RECEIVERS AND AMPLIFIERS

A.

A.

DEGALLIER'S, Ltd., the firm for reliable short wave radio, have on show in London the largest selection of fully guaranteed brand new all-wave receivers; callers invited to handle all these at their leisure without obligation to purchase; all S.W. receivers will get stations on the low bands, including the Americas, etc. Closed all day Mondays. All goods cash with order or e.o.d. Hand-somely illustrated catalogues forwarded on receipt of large stamped addressed envelope or stamp 2½d. Our models receive American transmissions at full programme strength; demonstrations daily after 4.30.

6/6 Each.—Valves for American receivers, all guaranteed, each a first, no seconds or throw-outs; for every known set from 1927-37; metal, metal glass, glass counterparts, and glass; in ordering just state type and number, we have it, all post paid; line cords for all midgets, 4/6 each.

£3/10.—T.R.F. Midget receiver, "The smallest of its type in the world," medium and long wavebands, moving coil speaker, 2 watts output, no earth required, compact and transportable, leather cloth covered, obtainable in various colours; carriage 1/-.

£7/7.—Table model six-valve all-wave superhet, tuning 16½-50, 200-250, 800-2,000 metres, high efficiency resistance-capacitance circuit with A.V.C., station calibrated dial, 8in. moving coil speaker, cabinet of handsome appearance and super acoustic, 17x13x9½, operates on A.C. or D.C. mains, 200-250 volts; never before such tone from a D.C. receiver, carriage 4/6.

13 Gns.—The new Challenger 8 (type 800) table model De Luxe, 22x18x12, high fidelity 8-valve superhet, A.C. 200-250 volts, waveband coverage 11-32, 27-65, 190-550, 900-2,000 metres, simplified centralised tuning, super slow motion vernier slow-fast tuning dial calibrated in metres, with station names, self contained control panel, perfect tone quality at low volume, new type, M.C. 10in. speaker, from a whisper to 8 watts pure undistorted tone, no overloading at full volume, oscillator fundamental without use of harmonics, persistent oscillator of highest output, isolating filters eliminate oscillation and motor boating, fully delayed A.V.C., P.U. terminals (switching and volume control incorporated in the front panel), absolute minimum of noise, sensitivity control for noise suppression. Reinforced capacitors prevent drift, pre-aged intermediate frequency transformers, I.F. barrier discs, anchor coil leads, plug-in loudspeaker, moisture sealed out by tropical zone impregnation, self heating electrolytic condensers. One complete chassis of dreadnought construction, moderate voltages assure full valve life, economical to operate, 75 watts consumption, correct valve selection, no compromise, no hum, full weight transformers, true push-pull, stabilised H.T. supply, stabilised biases, ceramic coil insulation, fully loaded plate coils give maximum gain, pre-balanced coil assembly, sealed insulation, thin laminations of special silicon steel, 7 k.c. selectivity, fractional microvolt sensitivity, shielded

(This advertisement continued in third column.)



SIX TOSCANINI CONCERTS

—and if any of the well-known musical critics listen to them by radio, we know quite well what they will say. "Wireless is still unable to show the finer shades of orchestral performance . . . the bass strings are untruthful . . . radio cannot show the true tone-colour of the massed strings . . . why is it that choral music has a harshness? . . ." and so on and so forth.

You see, music critics don't read "The Wireless World." So they don't see our advertisements and most of them still use unfaithful sets.

With Hartley-Turner reproduction you can't put your finger on obvious defects such as these. We don't claim that our stuff is perfect—but it needs a keen ear, close study and measuring apparatus to find anything wrong.

And please don't think that this matters only to highbrows. Just the contrary. One of the most severe tests of a receiver is its reproduction of dance music: to get sousaphone and muted trumpet really lifelike is most difficult; and here again Hartley-Turner products are a revelation.

DEMONSTRATIONS

Please note that we are continuing our "open house" for a few weeks, but on Wednesdays only, not on Thursdays as well.

COME AND HEAR THEM



**HARTLEY TURNER
RADIO LTD.,
THORNBURY ROAD,
ISLEWORTH, MIDDLESEX.
Telephone: HOUNSLOW 4488**

(This advertisement continued in third column.)

NUMBERED ADDRESSES

For the convenience of private advertisers, letters may be addressed to numbers at "The Wireless World" Office. When this is desired, the sum of 6d. to defray the cost of registration and to cover postage on replies must be added to the advertisement charge, which must include the words Box 000, c/o "The Wireless World." All replies should be addressed to the Box number shown in the advertisement, c/o "The Wireless World," Dorset House, Stamford Street, London, S.E.1. Readers who reply to Box No. advertisements are warned against sending remittance through the post except in registered envelopes: in all such cases the use of the Deposit System is recommended, and the envelope should be clearly marked "Deposit Department."

DEPOSIT SYSTEM

Readers who hesitate to send money to advertisers in these columns may deal in perfect safety by availing themselves of our Deposit System. If the money be deposited with "The Wireless World," both parties are advised of its receipt.

The time allowed for decision is three days, counting from receipt of goods, after which period, if buyer decides not to retain goods, they must be returned to sender. If a sale is effected, buyer instructs us to remit amount to seller, but if not, seller instructs us to return amount to depositor. Carriage is paid by the buyer, but in the event of no sale, and subject to there being no different arrangement between buyer and seller, each pays carriage one way. The seller takes the risk of loss or damage in transit, for which we take no responsibility. For all transactions up to £10, a deposit fee of 1/- is charged; on transactions over £10 and under £50, the fee is 2/6; over £50, 5/-. All deposit matters are dealt with at Dorset House, Stamford Street, London, S.E.1, and cheques and money orders should be made payable to Iliffe & Sons Limited.

SPECIAL NOTE.—Readers who reply to advertisements and receive no answer to their enquiries are requested to regard the silence as an indication that the goods advertised have already been disposed of. Advertisers often receive so many enquiries that it is quite impossible to reply to each one by post. When sending remittances direct to an advertiser, stamp for return should also be included for use in the event of the application proving unsuccessful.

NEW RECEIVERS AND AMPLIFIERS

(This advertisement continued from first column.)

switching permits high gain, positive silver plated contacts eliminates switch noises, audio frequency range 30-8,000 cycles, diode detection, Prizmatone high fidelity, R.F. selector stages on all bands; carriage 5/6.

£12/18.—"800" chassis valves and 10in. speaker with all escutcheons, etc.; carriage 4/-.

£14/18.—"800" chassis valves and G.12 12in. Rola high fidelity speaker; carriage 6/-.

£17/17.—Challenger "800C" Console, height 3ft. 6in., width 24in., depth 12½in.; this is the 800 chassis with G.12 Rola; carriage and crate 10/-.

NOTE.—The Challenger 800 is available in 11-valve, A.C./D.C. 200-250 volts, at an additional cost of 20/- on each model.

29 Gns.—Challenger "800RG" radiogram, with automatic changer "Garrard", this job also incorporates the G.12 high fidelity Rola, carriage and crate 15/- A.C./D.C. model £2 extra.

14 Gns.—Challenger 381 8-valve 14-2,060 metres, Poly-chromatic dial scale, improved vision master, beam power output, band spread Magna dial and second-hand magic eye tuning, automatic band indicator, high image frequency suppression, hair line selectivity, 5 k.c. separation; carriage 5/6; less cabinet, £13/18; carriage 4/-.

THE Following Bargains Cannot be Repeated, owing to the fact that they are samples; these are also covered by the usual guarantee in Great Britain against faulty workmanship and materials; owing to the weight and difficulty in packing, these are available to callers only, and a visit to our showrooms will be well worth while.

£37/10.—Six only 1937 24-valve Garod receivers, twin chassis and 2 Public Address speakers, 5 wavebands covering 5-2,000 metres, 60 watts undistorted output; this chassis is also available in Console form at £7 extra, this cabinet alone cost to make over £15.

£35.—Three only 24-valve Lafayette twin chassis and 2 speakers, 5 wavebands, 8-2,000 metres, 30 watts undistorted; also 1 Console at £41/10, and 1 radiogram with record changer at £50.

DEGALLIER'S, Ltd., 18, Connaught St., Marble Arch, London, W.2. Paddington 2745. [4223]

ALERT RADIO Co.

COMMUNICATION Receivers, all-wave chassis, complete receivers of all types, American valves, spares and service; we also have a few reconditioned receivers.—21, East Rd., N.1. Clerkenwell 4871. [3787]

"SERVICE With a Smile."

HENRY FORD RADIO, Ltd.

ELECTRONIC House, 22, Howland St., Tottenham Court Rd., W.1. Museum 5675. [0511]

GALPINS ELECTRICAL STORES

75, LEE HIGH RD., LEWISHAM, LONDON, S.E.13.

TELE: LEE GREEN 5240. ALL GOODS SENT ON 3-DAYS APPROVAL AGAINST CASH

TERMS CASH WITH ORDER OR C.O.D.

SPARK COILS, 2 inch. complete with Condenser and all fittings, 17/6. Carriage forward. 8 inch. complete on stand with Condenser, 50/-, c/f.

X-RAY TUBES with Tungsten Targets, 15/-; with Platinum Targets, 20/- each. Packing free. C/F.

DYNAMOS, all fully guaranteed for lighting or charging. 12 volt 8 amp., 15/-; 12 v. 12 a., 17/6; 20 v. 5 a., 25/-; 20 v. 8 a., 32/6; 35 volt 6 a., 27/6; 25 volt 25/35 amp., four pole, compound wound, slow speed, as new, 90/-; 100 v. 10 a., 70/-; 50/75 v. 6 a., 70/-. Carriage forward.

CHARGING RESISTANCES or Shunt Regulators. Stud, switcharm type, 12/6 each, to suit your requirements.

C.A.V. AUTOMATIC CHARGING CUT-OUTS, suit any voltage, 7/6 each.

MOVING COIL and MOVING IRON Switchboard Meters. By well-known makers. Various readings, volts and amps., 12/6 and 15/- each.

MOTOR BLOWERS, 1/2 h.p. D.C. Blowers, 4in. inlet and outlet, 110 v. D.C., 35/-; 220 v. D.C., 45/-.

BULKHEAD ELECTRIC FANS, 12in. Blade, nickel plated, 100 volt only, laminated pole piece, condition as new, 10/- each.

"NEWHOUSE" VACUUM DESICCATORS, Complete in case with gauge, 40/-.

LARGE MAINS TRANSFORMERS, windings not known, 1/2 kilowatt, 15/-; 1 kW., 25/-; 2 kW., 35/- C/F.

TREADLE LATHE, Plain 3 1/2 inch Centre, 3ft. Bed, Compound Slidest, 4 inch Self-centring Chuck, fine condition, 44. C/F.

MOVING COIL METER MOVEMENTS for recalibrating into multirange, all-test Meter, 2 1/2in. dial, by well-known makers, 5/- each.

EX-G.P.O. MAGNETIC RELAYS, working current approx. 2 m.A., 7/6 each; post 6d. "Sullivan" Moving Coil Relay, in perfect working order, new condition, 45/-.

ELECTRIC LIGHT CHECK METER, Kilowatt hour, type, 200/250 volts, 50 cycles, single phase, for subletting garages, etc., in new condition, 6/-; post 1/- Shilling Slot type, by Met.-Vic., 17/6. C/F.

SULLIVAN TRANSMITTING VARIABLE Condensers, .0005 mf., glass case type, 12/6 each.

EX-R.A.F. MORSE KEYS, fully adjustable, price 2/6. Post 6d.

WESTERN ELECTRIC MICROPHONES, solid back type, very sensitive, 2/6 each.

MICROPHONE TRANSFORMERS, high ratio, finest quality, 2/6 each.

DIMMER SWITCH for 12-volt control, suitable for regulating electric trams, 12 v. lighting, etc., 2/6 each.

R.A.F. CHARGING CUT-OUTS, also fitted voltage regulators, fully adjustable, suitable for 12 to 20-volt charging dynamos, price 2/-. Post 6d.

COSSOR EX-R.A.F. 2-VOLT GENERAL PURPOSE VALVES, as new, 3 for 2/6. Western Electric 2 m.f. Condensers, 9d. each. T.C.C. 2 m.f. Condensers, 1/-. Microphone Buttons, 9d. 20-30 H. Mains Chokes, 40-60 and 80 m.A., 1/-, 1/6, 2/6 each. 1,000-ohm Earphones, 1/3 each; 2/- per pair. 1,000-ohm Bobbins, 6d. per pair. Small Horseshoe Magnets, 3d. each. .0003 and .001 Variable Condensers, 1/- each. Ex-R.A.F. Remote Control Panels, useful for components, 1/- each. Ex-R.A.F. Cutouts, 20 v. 3 a., with voltage regulator, 1/9 each. Belling 1 kW. Elements, 2/6.

B.T.H. VARIABLE RESISTANCES, 250 ohms, 1 to 3 amps., 15/- C/F.

PERMANENT MAGNET MOVING COIL SPEAKERS by well-known makers, fitted volume tone control, magnificent reproduction, ideal for extension speaker, 8/6 each. Post free. Complete in walnut cabinet, 14/-. Post free. A few only with slightly damaged cones, 4/- each.

MORSE KEY AND BUZZER SETS, complete, mounted on mahogany base, complete with sharp tone buzzer, solid brass construction, high-grade long wearing contacts, 5/- each. Post free.

ZENITH VITREOUS RESISTANCES, 3,000 ohms 200 m.A., 2/-; 2,000 ohms, 100 m.A., 1/-; 20,000 ohms, 50 m.A., 1/6; 1,000 ohms, 200 m.A., 1/3; 120 ohms, 1/2 amp., 1/- Post 3d.

WHEATSTONE BRIDGE, 5,000 ohms, in first class condition, 75/-.

WESTINGHOUSE H.T. RECTIFIERS, output 500 volts 250 m.A., as new, 25/- each.

AMERICAN, 10-Watt PUBLIC ADDRESS Amplifier, using 2 x 45's in push-pull for 100 to 250 volts A.C., in new condition, to clear, 45. C/F.

EX-R.A.F. 2-Valve-Amplifier, battery working, less valves, 6/- each.

4 ONLY 4-Valve Music Magnets, 2 S.-Grids, Det., Power. Guaranteed in working order, complete with valves, 30/- C/F.

4 ONLY Five-Valve Transportable Receiver, complete with valves, by well-known makers, 17/6 each.

LATHE, 6in. Centre, 5ft. Bed, B.G., S., Stand S.C., Hollow Mandrill, Double Vee Flat Bed, change wheels and stand. No plate on Chucks. In good condition, 115. C/F.

ROTARY CONVERTERS, 1,500 Watts, 110 v. D.C. input, 110 v. A.C., 50 cycle single-phase output, 90/-.

MARK III Star crystal set, carborundum and perikon detector, 300 to 2,000 metres. Buzzer tuned, as new, 45/-.

EX-G.P.O. TELEPHONE BELL BOXES, complete with twin gong bell, transformer condensers, etc., 3/6. Post 6d.

LARGE ROTARY CONVERTOR, 220 v. D.C. input and two D.C. outputs giving 12 v. at 60 amps. and 8.25 v. 1,500 watts in perfect condition, 45. C/F.

FRENCH ASTROLOBE, in case with compass, prism, eyepieces, false horizon, etc., in first class condition, 57/6.

NEW RECEIVERS AND AMPLIFIERS

AIR KING.

ALL Models Feature Beam Tuning, Magic Eye Indicator, gramo. pick-up connections, and special output valves.

ALL Sets Fully Guaranteed; H.P. terms available from 3/- per week.

WHOLESALE and Trade Enquiries Invited; generous terms.

ALL Types of American Valves Stocked; write for lists to

AIR KING RADIO, 115, Shaftesbury Av., Cambridge Circus W.G.2. Phone: Temple Bar 4875 (2 lines). All receivers assembled in England. [3406]

ANGLO AMERICAN RADIO, Ltd., introduce the following magnificent range of Crosley chassis for the Coronation.

CROSLEY'S Reputation and Unsurpassed Standard of Workmanship is Your Guarantee of Satisfaction.

CROSLEY Superheterodynes to Suit Every Need, from the unsurpassed 10-valve all-wave 5-band to the 6-valve short and medium wave 3-band; our Coronation cash prices save you 40-50% now.

£12/19/6—10-valve High Fidelity 5-band (13-31, 30-80, 75-200, 200-555, 750-2,000 metres), A.C. 97-240 volts, 10 watts undistorted output, metal valves, pre-H.F. stage on all bands, provision gramo and doublet push-pull output, super A.V.C., band-spread pointer, metre calibration of airplane dial; side by side tests prove that this receiver outperforms multi-valve sets with double the number of valves; you cannot buy a better set; the all-world reception is a revelation; the tonal quality from a whisper to the full 10 watts is magnificent; to-day's value £25, your price £12/19/6; with 12in. American Magnavox speaker, £15.

£11/19/6—9-valve, 5-band, A.C. 10 watts, as above but employing glass valves; with Magnavox speaker, £14.

£9/19/6—8-valve, 5-band, A.C., as above, but 4 watts undistorted; with 12in. Magnavox speaker, £12.

£8/19/6—8-valve, A.C. 3-band, 2 models; (1) 17.5-500, 200-555, 750-2,000 metres, 4 watts undistorted output, provision gramo. and doublet, pre-H.F. on all bands; with matched Magnavox speaker, £9/15.

£6/19/6—6-valve, A.C., 3-band, 2 models, as H.F. stage, gramo., doublet, large 7in. colour airplane dial; with Magnavox speaker, £7/15.

ORDER with Confidence—These Crosley radios bring nothing but unbounded satisfaction on all sides; whichever model you choose you know you simply cannot buy a better job in its class at double or treble the price.

49/6—2-valve A.C./D.C. short-wave superheterodyne converter, 10-200 metres, employs H.F. Pentode and own power supply, operates in front of any receiver with single connection, A.C./D.C. 100-240v., large dial with band-spread control, complete in attractive metal cabinet, an unprecedented bargain; secure yours to-day.

TERMS: Cash or cheque with order or c.o.d.; send your order now before the Coronation rush.

4 D. Stamps Post Free—Advance applications now being received for our wonder new radio catalogue; covers every radio need; receivers, communication sets, accessories, short-wave gear, etc., in colours and illustrated.

ANGLO AMERICAN RADIO (AND MOTORS), Ltd., Dept. W.15, Albion House, New Oxford St., London, W.C.1. (Showrooms: 39, New Oxford St.) Telephones: Temple Bar 3231, 9821. [4361]

ROYAL RADIO Co.

ALL-WAVE Receivers, suitable for use on ships, as supplied to officers of many shipping lines.

OUR 8 and 10 Metal Valve All-wave Receivers; 15-2,000 metres, acknowledged by the trade as the best for range, tone, and general performance.

LATEST 6-valve Car Radio, A.V.C., remote control, no suppressors required.

A FULL Range of the World Famous Ferguson and Pilot Models Stocked.

ALL Sets Fully Guaranteed by Ourselves.

ALL Types of American Valves Stocked.

PAY Us a Visit Any Time, or send for full range catalogue; 1/2d. stamp will be appreciated.

ROYAL RADIO Co., 5, Buckingham Rd., South Woodford, London, E.18. Phone: Buckhurst 2736. [4350]

RADIOGRAPHIC for All Communication Receivers, Hallicrafters, etc.; send for lists.

RADIOGRAPHIC, Ltd., 66, Osborne St., Glasgow, C.1. [4342]

HARMAUR RADIO for Wireless Receivers from £3/3; Raytheon glass and metal valves and all components; trade enquiries.

THE HARMAUR RADIO Co., Ltd., 8, Clifford St., New Bond St., London, W.1. [0499]

PILOT, Ferguson, Spartan, American transportable, car radio, and others; traders; lists.—Petersen Co., W.W., Burton-on-Trent. [4264]

£7/5—Six-valve all-wave chassis with 8in. Rola, B.V.A. valves, royalties paid, twelve months' guarantee.—Coulphone, Hutton, Preston. [4229]

QUALITY Receivers and Amplifiers for Discriminating Listeners; we quote for your requirements, service, repairs.—Simmonds Bros., 38, Rabone Lane, Smethwick. [4324]

FOR the Finest Value in All-wave Receivers, see McCarthy advertisement on Edit. page 431.—McCarthy Radio, Ltd., 44a, Westbourne Grove, London, W.2. Telephone: Bayswater 3201. [4358]

TRANS-ATLANTIC RADIO for the Finest All-wave Sets and Compacts; agents for Ferguson, Philco, etc.; radio service specialists.—Trans-Atlantic Radio Co., 15, Percy St., W.1. Museum 3096. [4353]

★ PRAISE FROM THE PRESS CLUB For Savage Sound.....

Dear Sir,
I am desired by my committee to tender you sincere thanks for the splendid installation of public address equipment recently installed in our dining room by you, not only for the very workmanlike manner in which your engineers carried out the work, but also the very helpful guidance given by your representative which has resulted in perfect reproduction.
My committee and members are full of praise for the amazing improvement this has made at our house dinners.

Yours faithfully,
A. LAZENBY,
Manager-Secretary

W. BRYAN SAVAGE LTD.



WESTMORELAND ROAD, LONDON, N.W.9
PHONE: COLINDALE 7131 (3 LINES)

"ENGINEERING OPPORTUNITIES"

This unique Handbook shows the easy way to secure A.M.I.C.E.

A. M. I. Mech. E.,
A. M. I. E. E.,
A. M. I. A. E.,
A. M. I. W. T.,
A. M. I. E. E., and similar qualifications.

WE GUARANTEE— "NO PASS—NO FEE."

Details are given of over 150 Diploma Courses in all branches of Civil, Mech., Elec., Motor, Aero, Radio and Television Engineering, Building, Government Employment, etc. Write for this enlightening Handbook to-day FREE and post free.

British Institute of Engineering Technology, 387, Shakespear House, 17, 18, 19, Stratford Pl., W.1.

FREE 268 PAGES

BTH SOUND AMPLIFYING EQUIPMENT

Including the:—
Latest Development in Moving Coil and Metal Diaphragm Horn Type Speakers.

THE FINEST TONAL QUALITY IN THE WORLD

BTH RUGBY
THE BRITISH THOMSON-HOUSTON COMPANY LIMITED, RUGBY, ENGLAND A2329N

CORONATION AMPLIFIERS—LOUD SPEAKERS—MIKES

We have a few bargains left in Mains and Battery sets. Rotaries up to 3 Kw.

ELECTRADIX RADIOS 218 Upper Thames St., London, E.C.1.

HIRE PURCHASE

We can supply any Radio and Electrical Apparatus on HIRE PURCHASE having a value of over £3 at convenient terms, including Midwest, Spartan, Challenger, Armstrong, Scientific Supplies and other receivers. Spartan Refrigerators, "Easy" Washing Machines, etc., etc.

CHAS. F. WARD, 46, Farringdon Street, LONDON, E.C.4. Tel.: Holborn 9703.

NEW RECEIVERS AND AMPLIFIERS

PEERLESS Chassis De Luxe Model, 1938, 11 valves, 12½ in. speaker, 4 wavebands, 18 watts output, specially made for short-wave reception; come up and test it; £14/14.—Kay, 47, High St., Camden Town, N.W.1. [4321]

PILOT, Ferguson, Belmont, Pegasus, and Air King all-wavers lead the field, our deliveries are prompt in original cartons, with full guarantees; your trade card will bring our wholesale catalogue from the authorised distributors.—Leonard Heys, 36, Henry St., Blackpool. [0530]

COMMUNICATION Receivers, Hammarlund, National, Hallicrafters, R.M.E.69, Tobe-Deutschmann; transmitters, Collins 45A, Peerless DX20, or built to order; American valves, microphones, Eddystone components.—A.C.S., Ltd., 52-4, Widmore Rd., Bromley. [Phone: Ravensbourne 0156] [0550]

RECEIVERS AND AMPLIFIERS
CLEARANCE, SURPLUS, ETC.

HENRY'S.

1937 Regentone De Luxe Model A.C. 200-250 3-waveband Superhet., 5 valves, 17.5 to 2,000 metres, handsome cabinet; list £10/10, our price £7.

1937 Regentone 3 Waveband A.C. 200-250, 17.5 to 2,000 metres, thermometer tuning; list 9 gns., £4/10.

1936 Regentone 5-valve Console, A.C. 200-250, thermometer tuning; list £10/10, £4.

1937 Regentone 3-valve Battery Set, H.F. pentode, det. and pentode output, moving coil speaker, thermometer tuning; list £6/2/6, £3.

FARREX Short Wave Units for A.C. Mains or Battery Sets; list £3/3, only a few left for 30/.

HENRY'S, 72, Wellington Ave., London, N.15. Stamford Hill 2907. [4360]

CLEARANCE List (Trade Only).—Write Leonard Heys, 36, Henry St., Blackpool. [0527]

ARMSTRONG Co. Have a Further Few Soiled but Genuine Brand New Radio Chassis for Disposal at Considerably Less Than Cost Price, described hereunder.

ARMSTRONG 1937 9-stage Radio-gramophone Chassis, covering 4 wavebands from 12.9 metres, circuit H.F. Pentode as radio frequency amplifier, tuned H.F. transformer coupled to hexode triode, detector oscillator, 2 triode, detector and L.F. amplifier stages, double diode triode, detector and L.F. amplifier, push-pull output stage capable of handling 6 watts, highest grade components used throughout, "Airplane" multi radio drive, all wavebands calibrated station names, tone control works on both radio and gramophone, provision for extension speaker, etc.

SEVERAL Chassis as Above, brand new, but chassis slightly marked; price, complete with Mullard valves, 9 gns.; an exceptional opportunity.

ARMSTRONG Co. Also Offer Few Genuine 1937 Armstrong 6v. All-wave Superheterodyne Radiogram Chassis, brand new but cellulose slightly marked, complete with new full size Rola moving coil speaker and 6 new and fully guaranteed Marconi or Mullard valves; these chassis are the well known 3BPT models containing high grade British components, are ganged and aerial tested, and ready to switch on; price £6/10, complete.

ARMSTRONG Co. Have Technical Data Sheets Available.

ARMSTRONG Co. Will Willingly Send Above Chassis on 7 Days' Trial, carriage and packing free.

ARMSTRONG MANUFACTURING Co., 100, King's Rd., Camden Town, N.W.1. [4343]

PUBLIC ADDRESS EQUIPMENT

SPECIAL Offer!!!

81 Gns. Complete.—Vortexion portable 15-20 watt 4-stage amplifier, independent mike and pick-up inputs, outputs for 7½ and 15 ohm speakers, weight 25lb., 4 independent input model, £10.

HEAVY Duty 20 watt model, as fitted to dance halls and cinemas, etc.; £15, complete with valves.

60 Watt Model for 6L6s, with microphone and gramophone independent inputs, and outputs for 4, 7½, 15 and 30 ohm speakers, consumption 150 watts, in ventilated steel carrying case; £24 only! complete with valves less two 6L6s.

WHY Not Call and Have a Demonstration.

VORTEXION, Ltd., 182, The Broadway, Wimbledon, S.W.19. Phone: Lib. 2814. [4254]

ALL Types of Public Address Apparatus for Sale or Hire.

WARD, 46, Farringdon St., London, E.C.4. Tel.: Holborn 9703. [0555]

£10.—Engineer-built 30-watt paraphase amplifier, unused.—16, Glenwood Grove, N.W.9. [4340]

TRADERS, write for our lists; all best makes equipment supplied.—Perseus Co., W.W., Burton-on-Trent. [4266]

PARTRIDGE P.A. Manual, free to trade. See "Partridge Transformer" under "New Mains Equipment." [3487]

ML Rotary Converter, 6 to 12 volts input, 400 volts 300 M.A. output, list £14 odd; sell £5.—Grainger, Forest Row, Sussex. [4330]

HARMONY HOUSE SOUND SERVICE, Southport.—Beam power amplifiers, 14 watts output; £13/10 (subject); send for lists. [0546]

EPOCH Public Address Speaker, P.E.E., £3; 10-record automatic gramophone, Webster pick-up, £6.—Box 1700, c/o The Wireless World. [4349]

EASCO 1937 Super Mobile P.A. Van, available for engagements Coronation Week, with operator driver.—Reliance 1693. Easco, 18w, Brixton Rd., S.W.3. [0544]

IDEAL for the Coronation.—8-watt amplifier, complete in cabinet with motor, pick-up, valves and speaker; £14.—Buckingham, 158, Pixmore Way, Letchworth. [4309]

TWO Bakers' Super Cinema Speakers, A.C.-D.C., 200-250v., fitted triple diaphragm, £4 each; three Voigt Tractrix horns, as new, £3/3 each, complete.—30, High St., North Finchley, Hill. 1183. [4327]

Notes

on the Suppression of Electrical Interference with Broadcast Reception

Reports from representatives and general correspondence tell us that interference in some towns is very much worse than in others. For example, we know that Hull is a hotbed of electrical interference and therefore we were particularly pleased to get this letter from a wireless dealer in Holderness Road.

"I have recently installed an 'Eliminoise' aerial system and am more than satisfied. Unfortunately I have been unable to place my aerial completely out of the field of interference on account of very high telephone wires crossing all over the place. Results more than justified your claims. I may say that I have tried 'noise suppression' aeriels before, doublets, etc., but this is the first time I have met with any success. I am on the main road right among the noise."

A rather different type of installation is where large factories use radio for the entertainment of their staff, either at work or in the canteen. We have such a case where a high gain receiver is being used in a department having 60 electric motors ranging from ½ to 20 h.p., so it is better to leave the interference to the imagination rather than make any attempt to describe it. No attempt was made to suppress at the source. Only an "Eliminoise" aerial was erected 15ft. above the roof level, and a mains filter, type 300, fitted in the set lead. The results were excellent, much to the agreeable surprise of the Works Engineering Department.

These two cases should be of particular interest to the home listener, because what can be achieved under such adverse conditions is easy in the average residential district.

When interference is troublesome, first of all fit a type 300 mains filter in the set lead; if that does not cure the trouble, radiated interference is being picked up on the aerial system and an "Eliminoise" will be required. If radiated and conducted interference are both present an "Eliminoise" and a type 300 Set Lead Suppressor will be required.

When compulsory legislation is actually on the statute book those who have control over electrical plant will have to see that it is not capable of creating too much interference. It is appreciated by the authorities that complete suppression at the noise source would be prohibitive in price, even if always practicable. It is hoped that those who will be content to listen to their local station will not be troubled with interference, providing they have a reasonable aerial and earth. Listeners who want to get anything like the best out of their receivers will still need to fit mains filters in the set lead, and in many cases "Eliminoise" aeriels.

* "Eliminoise" (Trade Mark) Anti-interference Aerial. All broadcast bands to 2,000 metres, 35s.

"C" type Shielded Cable, extra per yard, 10d.

† Type 300 Mains Filter, for set lead, 10 to 2,000 metres, 21s.

Send for the book, "Interference Suppression," post free 1s. 2d., or for free copy of "The Eliminoise System" and other relative literature.

BELLING-LEE SUPPRESSION SERVICE

Belling & Lee Ltd.
Cambridge Arterial Road,

Enfield, Middx.

Telephone: Enfield 3322.

PUBLIC ADDRESS EQUIPMENT

"FL" Loudspeakers, £6/15; B.T.H. microphones, £3/5; E.D.C.C. rotary transformer, input 12 volts, output 400 volts, £6/10; amplifier, £5/15.—Sound Amplifiers, Vernon Place, Cheltenham. [4334]

AMPLIFIED Speech and Music for Fetes, sports meetings, etc., using our public address mobile equipments, also smaller equipments for dinners, dances, conferences, etc.—Harmony House Sound Service, Southport. [0548]

ARMSTRONG Latest Coronation 30-watt Public Address Amplifier, incorporating 3 input circuits and self contained Fader system. Both microphone stages have a total gain of 97db. and are electron coupled. This apparatus is particularly suitable where large output is required.

TECHNICAL Details: 3-stage L.F. amplifier having 3 inputs, both microphone stages use L.F. triodes, which are electron coupled, the input impedance of both stages remaining constant; first input stage coupled to L.F. triode, which incorporates gramophone input circuit; the output stage is push-pull class A.B. with self bias, transformer coupled to preceding stage; power is obtained from a unit using 2 full wave rectifiers. The whole equipment constructed on 2 heavy pressed steel chassis; the finest British materials are used throughout; price, complete with 7 British valves, 16 gns., for 200-250 A.C. mains.

ARMSTRONGS, 100, King's Rd., Camden Town, N.W.1. Phone: Gulliver 3105. [4243]

NEW Portable Public Address Equipment, built-in electric gramophone, motor and pick-up, tone and volume controls, Miersphone pick-up and switch, high gain circuit, pentode stage followed by transformer stage, feeding push-pull output giving 15 watts undistorted, well finished and equipped.—Offers to D. Hiley, 21, Idmiston Rd., London, S.E.27. Phone: Streatham 6417. [4322]

USED SETS FOR SALE AND WANTED

CAR RADIO

PHILCO Repairs and Installations, trade distributors.—Radiorite, Ltd., Moorfields, Liverpool. Bank 8811. [4321]

FERGUSON Car Radio, 5v., 12v., chromium plated, complete, plug suppressors, condenser, new; £5, or nearest.—Baker, 26, Crompton Rd., Acton, W.3. [4325]

HAYNES

RADIOGRAM, Haynes latest H.F. tuner, 6-watt resistance coupled amplifier; £17, offers; must sell; demonstrated after 6.—Wim. 4230. Bryant, 2, Ridgway Place, Wimbledon. [4354]

HARTLEY-TURNER

HARTLEY-TURNER CS7A Console Receiver, with twin diaphragm speaker, original price £36; used demonstrations only; £25; spare twin diaphragm speaker, P.M., £3/15.—Purley Radio, Ltd., 52, Godstone Rd., Whyteleafe. Phone: Uplands 4526. [4331]

MISCELLANEOUS

G.E.C. Rack Radio Unit, 7-valve superhet., new valves, £9; also Eddystone Battery Four, 1936, 4 gns.—4, Spring Mews, London, W.1. [4338]

NEW MAINS EQUIPMENT

V

V

VORTEXION Quality Transformers.

VORTEXION Supply the B.B.C., G.P.O., L.P.T.B., I.C.I., Borough Councils, etc. Why not you?

ALL Fitted Screened Primaries, and tapped 200-250v. with centre tapped filaments, guaranteed one year.

W.W. Q.A., 425-0-425v. 120-160 m.a., 4v. 5-10a., 4v. 2.5a., 4v. 1-2a., 4v. 1-2a., super shrouded model; 32/-.

500-0-500v. 150 m.a., 4v. 4a., 4v. 2.5a., 4v. 2a., 4v. 2a., 4v. 2a., super shrouded model, 2.5% regulation, 35/-; open type, 32/-; 400 or 450v. same price.

350-0-350v. 120 m.a., 4v. 2-6a., 4v. 2-4a., 4v. 1a., 4v. 1a., super shrouded, 25/-; normal shrouded, 21/-; open type, 18/6.

350-0-350v. 75 m.a., 4v. 2-4a., 4v. 1-2a., shrouded, 18/-; open type, 16/-.

250-0-250v. 60 m.a., 4v. 2-4a., 4v. 1-2a., shrouded, 15/-; open type, 12/6.

AUTO Transformers, 100-120 to 200-240v.; 80 watts 11/-, 120 watts 14/6, 200 watts 21/-, 500 watts 37/6.

CHOKES—30h. 60 m.a., 7/6; 7-13h. 120 m.a., 12/6; 30h. 150 m.a., 15/-.

OUTPUT Transformers—4-10 watt W.W. Q.A., 21/-; 20 watt super shrouded, 30/-.

VORTEXION, Ltd., 182, The Broadway, Wimbledon, London, S.W.19. (Telephone: Liberty 2814.) [3951]

TANTALUM for A.C. Chargers, H.T. and L.T.—Blackwell's Metallurgical Works, Ltd., Carston, Liverpool. [3984]

PARTRIDGE Transformers, as supplied to B.B.C., Marconi's, G.E.C., Mullards, I.C.I., Tungram, etc.

SPECIALS Despatched Within 48 Hours; all standard types from stock.

SPECIAL Quotations to Manufacturers for Lots of 6 Upwards, hand wound, individually tested, immediate delivery, rock bottom prices.

TELEVISION Transformers Insulated to 10,000v. A.C. expert knowledge of transmitting requirements (mains and modulation).

HIGH Fidelity (20 to 15,000 Cycles) Intervalve and Output Transformers a Speciality.

PARTRIDGE P.A. Manual Free to Trade Only; contents includes constructional amplifiers, notes on microphone, pre-amplifiers, lines, mixing impedance matching speakers, etc.

PARTRIDGE, N., B.Sc., A.M.I.E.E., King's Buildings, Dean Stanley St., London, S.W.1. Phone: Vic. 5035 [3717]

—13 DAYS—

Judging by the number of enquiries we are receiving for P.A. equipment, quite a lot of people already appreciate that there is less than a fortnight to go before that great event the "CORONATION."

Undoubtedly more P.A. equipment will be used than ever before, and we are having to increase our Staff to cope with incoming orders, since we know that the S.S. Equipment will be an advertisement to our mutual advantage, in other words a veritable Talking example of efficiency.

May we send YOU further particulars of our 30-watt and 14-watt Amplifiers?

Both these models represent a concentrated effort to produce an ideal equipment embodying every known refinement at a reasonable price.

SOUND SALES

MARBOROUGH RD., UPPER HOLLOWAY, LONDON, N.19. (Contractors to the G.P.O., etc.) LIMITED. Tel.: Archway 1661/2/3

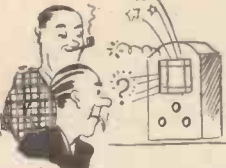

Crtd Smithson, "What's this that I've got, Is it Mars or Australia, or what? But his pal merely said, You've got crackle, instead Of the Fluxite your wiring did not!"

See that **FLUXITE** is always by you—in the house—garage—workshop—wherever speedy soldering is needed. Used for 30 years in Government works and by leading engineers and manufacturers. Of Ironmongers—in tins, 4d., 8d., 1/4 and 2/8.

Ask to see the **FLUXITE SMALL-SPACE SOLDERING SET**—compact but substantial—Complete with full instructions, 7/6.

Write for Free Book on the art of "SOFT" SOLDERING—and ask for leaflet on **CASE-HARDENING STEEL** and **TEMPERING TOOLS** with **FLUXITE**.

TO CYCLISTS! Your wheels will NOT keep round and true unless the spokes are tied with fine wire at the crossings AND SOLDERED. This makes a much stronger wheel. It's simple—with **FLUXITE**—but IMPORTANT

THE FLUXITE GUN

is always ready to put Fluxite on the soldering job instantly. A little pressure places the right quantity on the right spot and one charging lasts for ages. Price 1/6.



ALL MECHANICS WILL HAVE

FLUXITE

IT SIMPLIFIES ALL SOLDERING

FLUXITE LTD., Dept. W.W., DEAGON WORKS, BERMONDSEY ST., S.E.1

MAINS EQUIPMENT

SECOND-HAND, CLEARANCE, SURPLUS, ETC.

AUTO Transformers, Vortexion, Heayberd, 100-120v., 200-240v., 60 and 80 watts, 5/-; 120 watts, 6/6.—Baker, 26, Crafton Rd., Acton, W.3. [4326]

CABINETS

RADIOGRAM Cabinets, new designs, 30/- to £5/10; inspection invited or photos for selection sent on request.

TABLE Radio Cabinets, undrilled, 6/6 upwards.

SPEAKER Cabinets, 4/6 upwards.

MANUFACTURERS' Clearance.

ULTRA Radiogram Cabinets, undrilled, 33x23x14 or 33x20x15, 30/-.

BURGOYNE "Fury" Radiogram Cabinets (undrilled), 34x22x16 1/2; 49/6.

K.B. De Luxe Walnut Cabinets, undrilled, chromium plated edges and speaker grille, 25in. wide, 14 1/2 in. high, 10 1/2 in. deep, 18/6; Console model, 42in. high, 21 1/2 in. wide, 11 1/2 in. deep, 39/6.

HALYCON Radiogram Cabinets (Reconditioned), 33x23x19, 35/-.

H. L. SMITH and Co. Ltd., 287-9, Edgware Rd., London, W.2. Tel.: Pad. 5891. [0485]

DYNAMOS, MOTORS, ETC.

ALL Types of Rotary Converters in Stock, new and second-hand.

WARD, 46, Farringdon St., London, E.C.4. Telephone: Holborn 9703. [0518]

ELECTRO Dynamic Rotary Converter, used with Marconiphone radiogram 258, D.C./A.C. (250-230 volts), filter and soundproof cabinet.—Box 1659, c/o The Wireless World. [4316]

SHORT-WAVE EQUIPMENT

AMERICAN Reception Guaranteed on Any Receiver with the Ridco "Ranger" Short Wave Unit, price 37/6, complete on easy terms; send for illustrated lists.—Radio Industries, Birch St., Hanley, Staffs. [4263]

LOUD-SPEAKERS

SECOND-HAND, CLEARANCE, SURPLUS, ETC.

ROLA Speakers, brand new, boxed.

8IN. 1,000 ohms, with matching transformer, 6/6, postage 6d.—Linecords 2/—(American).

POWER Transformer, 6.3v. 2 1/2 amp., 5v. 3 amp., 350-0-350, 100 m.a., 8/6, postage 6d.

RADIOGRAPHIC Ltd., 66, Osborne St., Glasgow, C.1. Bell. 848. [4297]

R.K. Senior, 200-250v., D.C., built-in 3-ratio transformer, £2/17/6.—Roe, 206, Bristol Rd., Birmingham, 5. [4328]

B.T.H. Tweeter, 2,000, 0.5 ohm speech, 2,000-15,000 p.p.s., slight laboratory use, 50/—Richardson, 85, Station St., Birmingham. [4306]

VAUXHALL.—All speakers previously advertised are standard lines, ready for immediate delivery.—Vauxhall Utilities, 163a, Strand. [4345]

1937 Manufacturer's Surplus Magnavox "33," £2/5; Rola G12, £2/10; 1250 field push-pull transformer.—Spencer Radio, 318, Queens Drive, Walton, Liverpool, 4. [4339]

NEW LOUD-SPEAKERS

BAKER'S Quality Surplus Speakers.

HITHERTO Baker's Surplus Speakers Have Been Sold Through Agents; quality enthusiasts in search of a bargain can now obtain these speakers direct from our works. The following speakers are all brand new 1935-1936 models, and are offered at considerably under half list prices. If you are requiring quality reproduction at low cost, order one of the following exceptional bargains now. You will be amazed at the value obtained.

THE Auditorium Models are Fitted With Latest Triple Cone, comprising main curved cone and bakelite and duralumin cones combined, giving wide and even frequency response resulting in quality reproduction of both speech and music.

39/6 Only, usual price £5.—Auditorium Permanent Magnet Speaker, with Alni magnet and die cast frame, large 12in. triple cone giving wide frequency range, complete with large 25 ratio transformer suitable for all outputs, including push-pull and Class B, etc.

59/6 Only, usual price £6.—Auditorium Electro-Magnet Speaker, 1,000, 1,250, 2,000 or 2,500 ohms field exceptionally large magnet of high permeability steel giving enormous flux density, 2in. moving coil, large triple cone giving wide frequency range, complete with universal transformer, the ideal speaker for use with "Wireless World" and other quality amplifiers.

75/- Only, usual price £9.—As above, but for use on A.C. mains; complete with Westinghouse rectifier and full smoothing equipment.

24/- Only.—Permanent Magnet Speaker, Alni magnet, die cast frame, 10in. cone, Universal transformer.

15/6 Only.—Permanent Magnet Speaker, Alni magnet, 8in. cone, Universal transformer.

12/6 Only.—Permanent Magnet Speaker as above, with 7in. cone.

2/9 Only.—Brand new cabinets, 12x10x6.

8/6 Only.—Electro-Magnet Speakers, with 8in. cone, 6,500 ohms field, Universal transformer.

ALL Baker Quality Surplus Speakers are Sold for Cash or C.O.D.

BAKER'S SELHURST RADIO Ltd., The Pioneer Manufacturers of Moving Coil Speakers, 1925-1937.—75-77, Sussex Rd., South Croydon. (Croydon 3441.) [4347]

VAUXHALL.—Best quality speakers; see other column last week.—Vauxhall Utilities, 163a, Strand. [4346]

ELECTRADIX BARGAINS

TELEPHONES for HOUSE, OFFICE, GARAGE, and Field Sports. Table, Wall and Waterproof Portable, from 10/-. Headphones for short-wave radio, etc., 2/9 pair. Telephone Exchanges and wire cheap.

MOTORS & MOTORS! Tiny, Small and Medium house-power. We have a large stock of really high-grade Motora, Dynamos and Alternators for immediate delivery. Battery Motors, A.C. Mains Motors, 100/250, D.C. Mains Motors, 50/250 at prices from 15/-. See list. Rotary Converters from 37/6. 10 amp. Charging Dynamos, 25/-.
PUMPS AND COMPRESSORS. Coronation Fountain Electric Pumps, for A.C. or D.C. mains. Centrifugal, all-bronze for 6in. fountain, etc., 67/6. Larger pumps quoted for.

AIR COMPRESSORS for Paint Spraying, Set Cleaning, Inflation, Electric drive or manual, etc. Foot Operated, 37/6. 230 v. Electric No. 1 size, £5 15/-. Twin and single Compressors to 4 cub. ft.

CORONATION LIGHTING. Strand 12 circuit contact flasher with 60-1 gear box and a G.E.C. 8 circuit ditto motor driven. Large Neon decoration on panel coloured butyrdly with transformer 230 v. mains. Cheap on-off flashers for your illuminations, 100 watt capacity, 2/- each.

SEARCH LIGHTS AND FLOOD LIGHTS, Cable Resistances, etc. Porcelain Cleats, 6d. pair. **ELECTRIC LIGHT,** 1,000 Porcelain Ceiling Roses with Ramie Junction Connectors, 5/- doz.

HOME RECORDING
at low cost. Electric Peigh set has ball bearing centre gear box and geared traverse rod. Price with Tracking Gear, Pick-up and Tone-arm with diamond, 37/6.

For experimenters requiring gear only, less Pick-up and Tone-arm, this is 21/6. Diamond Cutter Needles, fit all pick-ups, 7/6. Blank Discs, 4/- dozen. Complete Acoustic Sets de Luxe, 21/- No. 2, 12/6; Junior type, 7/6 each, complete.

COMPLETE OLDFHAM 240 v. H.T. Accumulator 5 m/a capacity in 4 crates. An 8-guinea job for 45/-, with acid and charged.

GAMBRELL NOVOTONE TYPE J. Tone Compensator for any pick-ups. List three guineas, sale 25/-.
FLUORAC 250 v. mains chassis sets. Band pass circuit, very selective. Complete less valves at the low clearance price of 30/-. each. Leaflet free.

RADIO-GRAM CABINETS. Vertical console type, nice condition, mahoz and walnut, 22/6 each. Carriage and packing at cost.

2-VALVE METAL B. CHASSIS. Drilled and fitted 2 valve holders, transformer, coil, etc., 2/6 each.

SLOPE FRONT TEAK CABINETS. New, make fine instrument panel. 10x7x11. 3/- each.

H.M.V. Band pass, three coils on paxolin with long, short, and medium windings. 1 1/4 x 8 in. with brackets, 1/-. Philips canned set of 3. 3/PHILIPS. 30-1 transformers, makers type, 1 1/4 x 3 Radio Output transformers 15, 24 and 33 to 1, 2/6. West. Elec. HF Chokes 5in. x 2in. Fax for interference units, etc., 9d. 12in. Hot Plates for 110 v., 7/6. Electric Wallcoats 12v. wash-leather, 7/6. Fur Helmets, 2/6.

COIL TURN COUNTERS for checking the number of turns up to 9,999 on dial. Scaled, 1/3 each, as illus.

BELL SETS. Best British Trembler, 2/- each. Porcelain super-grade Pusher, 2/6 line for 6d. Brass Flange, 1/6. Door Barrel, all brass, 2/6. Twin lead-covered Wire, 4d. per yd. Indoor Bell Wire, single, 100 yds, 1/6; twin, 2/-. Transformers for ringing 100-v. A.C., 2/6; 200/40 A.C., 3/9.

STUD SWITCHES. 7 Stud on ebonite with plug, 1/9. Yaxley wavy change, 2-gang with knob, one hole, 1/2. Reyrolle Power Plug, 15 amp. shrouded panel, wall, two pairs on iron box, unused, 10/-. 20 Stud switches on slate panel, 10/6.

LESDIX SELENIUM CELLS are light, sensitive with gold grid, moisture proof, 5/-. Mounted in Bakelite Case, 7/6. Super-model in oxy-brass body with window, 10/-. Projector Lanterns, with flex and holder, 17/6.

PHOTO CELL. Sensitive R.C.A. 867 for 25/-. Holders 1/-. Illus. leaflet. Beck mounted prisms 5/6. P.O. Lens 3/6. R.C.A. Micro Adjusters 1/- MICROPHONES. 1/-, 5/6, 12/6, 18/6, 50/- and 26.

METERS. All ranges and sizes in stock. Laboratory precision apparatus. Bridges, Uni-pivots, Galvos, Micro-Ammeters, Wave-meters, etc.

For 1,000 other bargains see Sale List "W," post free.

ELECTRADIX RADIOS

218, UPPER THAMES STREET, LONDON, E.C.4

Telephone: Central 4611

Yachting World

and Motor Boating Journal

The Leading British Yachting Journal

"THE YACHTING WORLD" deals with yachts of all types and tonnages, whether on the sea or inland waters. Every aspect of yachting and motor boating is covered in an attractive and interesting manner.

Every Friday 6^d.
ILIFFE & SONS Ltd.,
Dorset House, Stamford St., London, S.E.1

BOOKS on WIRELESS

Write for complete list to
ILIFFE & SONS LTD.
Dorset House, Stamford St., London, S.E.1 W.W.4

VALVES

ANDERSON.
AMERICAN Valves, all makes, first grade only; 5/- each.
ANDERSON, 35, Lansdowne Rd., Walthamstow, E.17. Walthamstow 0827. [3351]
RADIOGRAPHIC is the Right Place for all American Valves.
 Each Any Popular Type. Don't waste time asking us, send P.O., or c.o.d.; 3 months' guarantee.
RADIOGRAPHIC, Ltd., 66, Osborne St., Glasgow, C.1. [4298]
TRADERS, write for lists, cheap and best American and replacement mains and battery valves; lists.—Perseus Co., Burton-on-Trent. [4265]
AMERICAN Valves, first grade, in all types; trade supplied.—Metropolitan Radio Service Co., 1021, Finchley Rd., N.W.11. Spedwell 5000. [0436]
ALL Types of American Valves in Stock of Raytheon, Sylvania, and Arcturus makes, at competitive prices, guaranteed for six months; send for full list; 350 ohms line cords, 2/8.
WARD, 46, Farringdon St., London, E.C.4. Tel.: Holborn 9703. [0452]
NOTHING Better Available. Six months' guarantee, complete range of battery, A.C. mains, rectifiers, always in stock, 2 volt det., H.F., L.F., 2/3; Power, 2/9; screen grid pentode, H.F. pentode, 5/-; American types, six months' guarantee, 5/6 each, Nos. 18, 24A, 35, 42, 43, 45, 47, 56, 57, 58, 75, 77, 78, 80, 2A5, 2A6, 2A7, 6A7, 2B7, 6B7, 6C6, 6D6, 25X5.—Write for other prices to Dulci Electrical Co., Devonshire Works, Duke's Ave., Chiswick, London, W.4. [0501]

METERS, ETC.

RADIOLAB Set and Valve Tester, little used, 6½ gns.; Wearite valve testing unit, as new, £3/10.—Box 1699, c/o The Wireless World. [4348]
FERRANTI Meters, 450 new and boxed; 38 discontinued types, approximately 75% off list; 200 O.P.V.; 1,000 O.P.V.—Farnell, 12, Heaton Park Rd., Bradford. [4307]
FROITZHEIM and RUDERT Automatic Coil Winder, Cotton interlay, cotton and accessories, Evershed Megger, Universal 34 range Avometer, Turner microammeter, Universal valve tester, Ferranti ohmmeter, several Ferranti meters, etc. cheap; stamp for list.—34, Topping St., Blackpool. [4351]

NEW COMPONENTS

MICROPHONES.—With much regret, owing to increased material costs, prices of our microphone kits must now be original—9/6, improved 11/-, De Luxe 13/6.
HOME Recording.—Cellophone, as proposed p. 411 last week; 2/- per dozen, 12-inch.
AHNDELICH, 2, Bridge Rd., London, N.W.10. [4337]
RIDCO Broadcasting Map Makes Station Identification Easy, mounted on glass panel, engraved in seven colours, size 9in. x 7in.; price 2/6, post free.—Radio Industries, Birch St., Hanley, Staffs. [4329]
CONDENSERS, British manufacture, fixed paper, in metal case; 1,000-volt wkg., 1 mfd. 3/7, 2mfd. 5/-, 4 mfd. 7/6; 800-volt wkg., 1 mfd. 1/9, 2 mfd. 2/3, 4 mfd. 3/9; 500-volt wkg., 1 mfd. 1/3, 2 mfd. 1/9, 4 mfd. 2/9; 400-volt wkg., 1 mfd. 8d., 2 mfd. 1/7, 4 mfd. 1/9; guaranteed; 1,000-volt wkg. tubular condensers, with soldering tags and metal bracket for fixing: 0.1 mfd. 10d. each, 0.25 mfd. 1/9 each, 0.5 mfd. 2/- each, 1 mfd. 2/6 each; postage 6d., or c.o.d.—Mentone Radio Stores, 364, Fulham Rd., London, S.W.10. [4341]

COMPONENTS

SECOND-HAND, CLEARANCE, SURPLUS, ETC.
RADIO CLEARANCE.
 ALL Lines Advertised Last Week Still Available.
RADIO CLEARANCE, 63, High Holborn, W.C.1. Holborn 4631. [4359]
PREMIER SUPPLY STORES.
 PLEASE See Our Displayed Advertisement on this page. [0488]
H. FRANKS is Reorganising his P.A. Depot and OFFERS the Following Bargains to Clear:—
H.M.V. Rack Amplifiers, comprising 1,000v. transformer, chokes, condensers, Turner meter, 200-250 input, etc.; breaking-up price, £4.
8,000 Siemens Halske ½-watt Wire Ended Resistances (new), 20 assorted sizes, 250 ohms to 2 meg.; 1/3, post free.
SIEMENS Halske Interference Locator, complete with valves, as new; 50/-.
GRAMPIAN PORTABLE P.A. Outfit, comprising A.C./D.C. amplifier, turntable, pick-up, M.C. microphone, speaker, etc., complete with valves, 6½ watts output; bargain, £10.
15 Watts A.C. Amplifier (Cinephone), 110-250v. A.C., housed in metal cabinet, Weston meters, complete with valves; £10/10.
SIEMENS Halske Ribbon Diaphragm Loud Speaker, handle 25 watts 240v. field supply, £4; ditto, handle 12 watts, 50/-.
MARCONI Rack Amplifier, 2 Ferranti meters, 0.500v., 0.500 mm., chokes, condensers, etc.; £3.
B.T.H. Speaker, 12in. cone, 1,000 ohm. field; 35/-.
FOSTER Powerpack, comprising 500-0-500 transformer 200 m.a., 7.5 volts, choke, condenser, etc.; 50/-.
GARRARD A.C. Turntable Pick-up, etc., in portable carrying case; £2.
WEBSTER A.C. Amplifier, 220v., complete with valves, needs slight adjustment; £5.
ML Converter, 200 D.C. in, 500-100 m.a. out, 35/-; A.F.3C., 10/-; O.P.M.3C., 10/-; A.P.M.1., 7/6.
RACON P.A. Units, 6v. field, 35/- each; B.T.H. heavy duty P.M. speakers, 30/- each; large quantity of dismantled amplifying gears at knock-out prices.
H. FRANKS, 81, New Oxford St., W.C.1 Temple Bar 2620 [4336]

PREMIER SUPPLY STORES

Offer the following Set Manufacturers' Brand New Surplus Goods at a Fraction of the Original Cost; all goods guaranteed perfect; carr. paid over 5/-; under 5/- postage 6d. extra. Orders under 5/- cannot be sent C.O.D.
ALL POST ORDERS TO
JUBILEE WORKS, 167 LOWER CLAPTON RD., LONDON, E.5
CALLERS, AS USUAL, TO 165 & 165A, FLEET ST., E.C.4 (Next door to Anderson's Hotel). Central 2833. New Branch:—50, HIGH STREET, CLAPHAM, S.W.4 (Macaulay 2381).
 Have you had our **GIANT ILLUSTRATED CATALOGUE AND VALVE LIST**? Send 4d. in STAMPS FOR THIS BARGAIN LIST.

MAINS VALVES, famous Europa 4 v. A.C. types, 4/6 each.
HL., L., S.G., Var.-Mu-S.G., H.F.-Pens., Var.-Mu-H.F. Pens. 1- and 4-watt A.C. directly heated output Pentodes. A.C./D.C. types. 20-volt 18 amp. S.G., Var.-Mu-S.G., H. H.L., Power, Pen, H.F. Pen and V.-Mu-H.F. Pen. Following types all 5/6 each. Full-wave rectifiers, 350 v. 120 m.a. and 500 v. 120 m.a. 2½-watt indirectly-heated Pentodes, Octode Frequency Changers.
BATTERY VALVES. 2 volts, H.F., L.F., 2/3. Power Super-Power, 2/9. S.G., Var.-Mu-S.G., 4- or 5-pin Pentodes, H.F. Pens., V.-Mu-H.F. Pens., 5/- Class B, 5/-.
AMERICAN VALVES. Genuine American HYTRON and TRIAD first-grade Valves. 3 months' guarantee. All types in stock, 5/6 each. 210 and 250, 8/6 each. New Metal-Glass Valves, all types, 6/6 each. Genuine American DUOTRON Valves, all types, 3/6 each. Valve holders for all above types, 6d. each. Octal bases, 9d. each.
SHORT-WAVE COILS, 4- and 6-pin types. 13-26, 22-47, 41-84, 78-170 metres, 1/9 each, with circuit. Special set of 3-4 Pin S.W. Coils, 14-150 metres, 4/- set, with circuit. Premier 4-pin 3-band S.W. Coil, 11-25, 19-43, 39-86 metres. Suitable any type circuit, 2/6. **C**OIL FORMERS, in finest plastic material, 1½in. low-loss ribbed, 4- or 6-pin, 1/- each.
SUPER CERAMIC CONDENSERS, S.L.P., .00016, .0001, 2/9 each; double-spaced, .00005, .000025, .000015, 3/- each. All brass with integral slow motion, .00015 tuning, 3/9; .00015 reaction, 2/9.
CERAMIC S.W. VALVE HOLDERS, 4-, 5- or 7-pin. Chassis types, 6d.; B.B. type, 8d. **G**LASS AERIAL INSULATORS, 4d. each. **B**EEHIVE STAND-OFF, 6d. each. **S**CREENED FLEX, single, 3d. vd.; twin, 4d. vd.
H.F. CHOKES, S.W., 10-200 metres, 9d.
ELECTROLYTICS, U.S.A., 4 or 8 mfd. 530 v. peak, 1/9 each. Dubilier, 4 or 8 mfd. 500 v., 3/-; 50 mfd. 50 v., 1/9; 10 mfd. 50 v., 6d.; 25 mfd. 25 v., 1/-; T.C.C. 8 mfd. 650 v., 4/-; 15 mfd. 50 or 100 v., 1/-; 50 mfd. 12 v., 1/-. **P**APER CONDENSERS, W.E., 250 v. working 4 mf., 2/-; 2 mf. 1/-, 1 mf. 6d.; 350 v. working 4 mf., 2/6; 2 mf., 1/6. Dubilier 500 v. working 4 mf., 4/-; 800 v. 4 mf., 6/-.
COSMOCOR PICK-UPS, with tonearm and volume control, 10/6 each. **P**ICK-UP HEADS only, 4/6 each.
PREMIER MAINS TRANSFORMERS, wire-end type with screened primaries, tapped 200-250 v. Centre-tapped Filaments. Guaranteed one year. H.T. 8 & 9 or H.T. 10 with 4 v. 4 a. C.T. and 4 v. 1 a. C.T., 8/6. 250-250 v. 60 m.a., or 300-300 v. 60 m.a., 4 v. 1 a., 4 v. 2 a., and 4 v. 4 a., all C.T., 8/6. 250-350 v. 120 m.a., 4 v. 1 a., 4 v. 2 a. and 4 v. 4 a., all C.T., 10/6. Any of these transformers with engraved panel and N.P. terminals, 1/6 extra. 500-500 v. 150 m.a., 4 v. 2-3 a., 4 v. 2-3 a., 4 v. 2-3 a., 4 v. 3-4 a., all C.T., 17/6. Super Model, 19/6. **A**UTO TRANSFORMERS, step up or down, 60 watts, 7/6; 100 watts, 10/-. **S**MOOTHING CHOKES, 25 m.a., 2/9; 40 m.a., 4/-; 60 m.a., 5/6; 150 m.a., 10/6. 2,500 ohms 60 m.a. Speaker Replacement Chokes, 5/6.
SPECIAL OFFER OF PHILIPS MAINS TRANSFORMERS. 250-250 v. or 300-300 v. 80 m.a., 4 v. 5 a. C.T. & 4 v. 1 a., 6/11. **L**ARGER MODEL WITH TAPPED PRIMARY, 100-250 v., 450-450 v. 150 m.a., 4 v. 4 a. C.T., 4 v. 4 a. and 4 v. 3 a. and 500-500 v. 100 m.a., 4 v. 4 a. C.T., 4 v. 4 a. and 4 v. 3 a., 12/6. **L**IMITED NUMBER ONLY.
MILLIAMMETERS, moving-iron, flush 2½in., all ranges from 0-10 m.a., 5/9. Visual tuning, 6 or 12 m.a., 5/9. Moving-coil meters, 2½in. 0-1 m.a., 18/6; 3½in. 0-1 m.a., 22/6. Multipliers, 1/- each. **A**mpmeters, 0-1, 3, 5, 10 or 20 a., 5/9. **T**RANSFORMERS, latest type Telsen R.G.4 (list 12/6), 2/9. Lissen Hypernik Q.P.P. (list 12/6), 3/6.
OUTPUT TRANSFORMERS for Power or Pentode, 2/6; Multi-Ratio, 4/6; Push-Pull Input Transformers, by prominent manufacturer, 4/6 each.

PREMIER L.T. CHARGER KITS for A.C. mains, including Westinghouse Rectifiers and Tapped Mains Transformers 8 volts at ½ amp., 14/6; 8 volts 1 a., 17/6; 15 volts 1 a., 19/-; 8 volts 2 a., 29/6.
TELSEN iron-cored screened coils, W.349, 4/- each. **E**lectric SOLDERING IRONS, 200-250 v., A.C./D.C., 2/3.
NEW 1937 1-VALVE SHORT-WAVE RECEIVER OR ADAPTOR KIT, 13 to 86 metres without coil changing. Complete Kit and Circuit, 12/6. **V**ALVE GIVEN FREE!
DE LUXE MODEL 14 to 150 metres, complete Kit with Chassis, 4 Coils and all parts, 17/6.
1937 SUPERHET CONVERTER KIT, 13/6.
DE LUXE MODEL, 18/6.
S.W. SUPERHET CONVERTER KIT, for A.C. Mains Receivers, 20/-. A.C. Valve given FREE!
NEW 1937 2-VALVE S.W. KIT, 13 to 86 metres without coil changing. Complete Kit and Circuit, 19/6. **V**ALVES GIVEN FREE. **D**E LUXE MODEL, 14 to 150 metres, complete Kit and Chassis, 4 Coils and all parts, 25/-. **V**ALVES GIVEN FREE. **3-VALVE S.W. KIT, S.G. Det. and Pen., 32/-.** **V**ALVES GIVEN FREE!
BAND-PASS TUNING PACK, comprising set of 3 Telsen iron-cored coils with switching, mounted on steel chassis with 3-gang condenser, illuminated disc-drive and 4 valve holders, 25/- the lot. All Mains or Battery circuit. FREE!
SPECIAL OFFER. **L**ISSEN TWO-GANG SCREENED ALL-WAVE COILS, 12 to 2,000 metres, complete with switching and wiring diagram, 6/11 per set.
3 VALVE BAND-PASS KIT, 200-2,000 metres. Complete kit of parts, including chassis, all components, valves, M.C. speaker and wiring diagram. Battery Model, 50/-. A.C. Mains Model, 70/-.
MAGNAVOX. Mains energised M.C. Speakers. '154', 7in. cone, 2,500 ohms, 12/6; '152', 9in. cone, 2,500 ohms, 17/6; '152 Magna', 9in. cone, 2,500 ohms, 37/6. Magnavox P.M.s.—'254', 7in. cone, 16/6; '252', 9in. cone, 22/6. Reliable P.M.s., 10/6. **T**ELSEN P.M.s. with 10 ratio Transformers, 12/6. **R**OLA latest type P.M.s., 15/-. **G**OODMANS' 8in. mains energised 1,000 ohms field, 10/6 each. Jensen P.M.s., 10/6. **B**.T.H. ENERGISED MOVING COIL, 10½in. diam. 1,650 ohms field. Power or Pentode Transformer. (State which.) **S**PECIAL LINE at 14/6.
Potentiometers by well-known makers. All values up to 1 meg., 2/-; with switch, 2/6. **G**RAMOPHONE MOTORS. Collaro Gramophone Unit consisting of A.C. motor, 100-250 v. high quality pick-up and volume control, 45/-; Collaro motor only, 30/-; Collaro Universal Gramophone Motor, 100-250 v. A.C./D.C., with high quality pick-up and volume control, 67/6; Collaro Universal Motor only, 49/6; Edison Bell double-spring motors, including turntable and all fittings, 15/-; Cosmocord Gramo. unit, comprising A.C. motor pick-up and volume control (list 55/-), 35/9.
TUBULAR CONDENSERS, non-inductive, all values up to .5 mfd., 6d. each.
Wire-end RESISTORS, any value, 1 watt, 6d.; 4 watts, 1/-; 8 watts, 1/6; 15 watts, 2/-; 25 watts, 2/6 each. **R**eliable **M**ORSE KEYS with Morse Code engraved on bakelite base, 2/- each. **B**akelite case **B**UZZERS, 1/6; Walnut case, "Loud-tone," 2/6 each. **S**uper Quality lightweight **H**EADPHONES, 3/9 pair.
UTILITY 2-GANG MICA DIELECTRIC CONDENSERS (2 x .0005) with Uniknob Trimmers and disc drive, 3/6.
POLA STAR 3-GANG (3 x .005) with Trimmers, fully screened, 5/6.
PREMIER FILAMENT TRANSFORMERS, 4 v. 3 a., C.T., 7/6; 4 v. 5 a., C.T., 8/6; 5 v. 3 a., 7/6; 6.3 v. 3 a., 7/6; 7.5 v. 3 a., 7/6; 2.5 v. 8 a., 8/6.

GRAMPIAN
 PUBLIC ADDRESS EQUIPMENT
P.A. at its Best
 GRAMPIAN REPRODUCERS LTD.
 Kew Gardens, Surrey.

WESTINGHOUSE
 METAL RECTIFIERS
 You can depend on
 WESTINGHOUSE BRAKE & SIGNAL CO. LTD. 62, YORK RD. KING'S CROSS N.1.

WEARITE
 METER UNIT
 AN IDEAL precision multi-range meter may be used with the Wearite Valve Tester. With first grade B.E.S.A. Moving Coil, 3½ in. diam. Instrument. Special arrangement for Output Meter.

20 RANGES
D.C. Volts - 6 Ranges - covering 0-1,000 v.
A.C. " - 6 " - " - 0-1,000 v.
Current " - 3 " - " - 0-100 ma.
Resist - 3 " - " - 0-1 megohm
Capacity - .05 to 4 mfds.
Inductance - 5 to 120 Henries
Price £6.17.6
 Free booklet on returning this announcement to—
WRIGHT & WEARE, LTD.,
 740, High Road, Tottenham, LONDON, N.17.

**COMPONENTS—SECOND-HAND,
CLEARANCE, SURPLUS, ETC.**

VAUXHALL.
VAUXHALL.—Polar Midget 3-gang condenser, straight or superhet, 8/9; Polar full vision, horizontal or Arcuate dial and drives, 5/-.
VAUXHALL.—J.B. drives with station-named scale, latest type, complete, 5/6; T.C.C. tubular, 0.25 mfd. 9d.
VAUXHALL.—Flat, sheet aluminium, hard rolled, 13 gauge, 12in.x12in., 3/-; 18x18, 5/6; other sizes pro rata.
VAUXHALL.—Hivac, Tungstram valves, full range; full discounts allowed from new prices.
VAUXHALL.—Polar station-named scales, for horizontal dials, latest settings; 1/9 each.
VAUXHALL.—Polar 2-gang condenser, 6/8; Colvern twin-gang iron cored coils, on base with switch, 20/-.
VAUXHALL.—Colvern coils, G1, G2, G3 or G1, G2, and G8, superhet type, 30/-; Colpaks, 22/4; Polar drives, 5/-.
VAUXHALL.—Iron-cored coils, 3-gang, on base, with circuits, 17/-; B.T.H. Minor pick-ups, 13/3.
VAUXHALL.—All-wave tuning pack, 16.5 to 52 metres, medium and long waves; 8/7.6.
VAUXHALL.—Hayberd low frequency smoothing choke, 10 henrys 120 m.a., fully shrouded; 11/6.
VAUXHALL.—Set manufacturers' surplus skeleton type Westinghouse rectifiers, H.T.8, 8/6; H.T.9, 9/-; H.T.10, 10/-; fixing brackets free.
VAUXHALL.—T.C.C. electrolytic condensers, 8 mfd. and 4 mfd., 550 volt, 3/-; 500 volt, 2/6; 450 volt, 2/5.
VAUXHALL.—T.C.C. condensers, tubular, non-inductive, 0.1 mfd., 50 mfd., 50v. working, 1/6; 50 mfd., 12v., 1/3; 0.05, 6d.; 0.002, 0.0002, 0.001, 0.0001, 4d. each.
VAUXHALL.—T.C.C. mica, 0.002, 2,000 volt test, 1/-; 0.0001, 4d.; 0.001, 1/-; 1 mfd. Mansbridge, 1/3.
VAUXHALL.—Resistances by well-known manufacturers, 1-watt type, 6d. each; all values.
VAUXHALL.—Centre tapped iron cored I.F. transformers, bases, terminals, 110 k/c., 6/6, guaranteed.
VAUXHALL.—Volume controls, Erie, Colvern, Centralab, 2/-; with switch, 3/-; all values, from 2,000 to 2 meg.
VAUXHALL.—Fusible wire, four colours, 6 yds. 6d.; 6B.A. screws of nuts, 4d. dozen.
VAUXHALL.—T.C.C. 200 mfd. 10v. dry, 2/6; 8 mfd., wt. 450v. working, 3/3; Westectors, WX6, 4/-.
VAUXHALL.—Colo A.C. electric motors, boxed, 28/-; similar model, complete pick-up and volume control, 45/6; Universal motors, 52/6.
VAUXHALL.—Clix valve holders, terminals, 7-pin, 9d.; 5-pin, 7d.; 9-pin, ordinary, 9d.; baseboard, 4-5-pin, 6d.
VAUXHALL.—Post paid 2/6 or over, or cash on delivery 5/- minimum.
VAUXHALL BOOKLIES. 163a, Strand, W.C.2, over Derry's, the Booksellers, Temple Bar 9338. Send postcard for lists free. [4344]
OLIVERS Offer.—Centralab volume controls, with switch, all values; 2/- each.
CHRISTIE Mounting Valve Holders, 5-pin 2 1/2d., 7-pin 3 1/2d.; aerial and earth socket strips, 4d.
ERIE 1-watt Colour Coded Resistances; 3 1/2d. each, 3/- dozen, 2/6 dozen in 3-dozen lots.
CARDBOARD Case Electrolytic Condensers, 4mfd. 1/6, 8mfd. 1/9, 4mfd.+4mfd. 2/-, 4mfd.+8mfd. 2/5, 8mfd.+8mfd. 2/9, ditto, separate negs. 3/8.
METAL Electrolytics, Dubilier 8mfd., 2/7; B.I. and T.C.C. 8mfd. 2/4, 4mfd. 2/1.
TUBULAR Cardboard Electrolytics, 1mfd. 1/-, 25mfd. 25v. 1/-, 60mfd. 12v. 1/-, 50mfd. 50v. 1/6.
NON-RING Valves and all American Types; best discounts and prices. Write for free lists and terms.
OLIVERS, 67c, Christchurch Rd., Boscombe, Hants.
OL All enquiries invited. Orders under 5/6 postage extra. [4323]
SOUTHERN RADIO'S Wireless Bargains; all goods guaranteed and sent post paid.
RECEIVERS.—Vidor 3-valve battery portable receivers, complete with 3 Osram valves, special Vidor long life batteries and accumulator, moving coil speaker, brand new, in sealed cartons; 23/17/6.
LUCILLE 5-valve American Midget Sets, complete with 5 valves, moving coil speaker, ready for use on any mains, 100-250 volts A.C./D.C., long and medium waves; 23/15, new, in sealed cartons.
RECORD Changers.—Garrard Model R.C.4, plays automatically and changes eight 10in. or 12in. records of any kind, new, in sealed cartons; 26.
GRAMOPHONE Motors.—Collaro electric radiogram units, for A.C. or D.C. mains, 100-250 volts, fully auto stop, complete with pick-ups, can be used on any mains, brand new, in sealed cartons, 57/-; Collaro spring gramophone motors, with 10in. turntable, complete with all accessories, 11/-; all Collaro motors are brand new, in sealed cartons.
SPEAKERS.—Celestion Soundex, permanent magnet, S 10/-; Telsen permanent magnet, with 10-ratio transformer, to suit any receiver, 12/6; Telsen loud speaker units, 2/6; all brand new and boxed.
COILS.—Telsen Iron core W349 (Midget size), 4/-; type W478 (twin), 9/- pair; type W477 (triple), 16/- per set; type W476 (triple superhet, selector and oscillator), 16/- per set; Telsen short wave coils, matched set of three, 4-pin bases, 12-26, 22-47, 41-94 metres, 5/- per set; Telsen dual range H.F. transformer and aerial coils, type W154, 3/- each; all ganged coils complete on base with switch; Telsen I.F. transformer coils, 110 k.c., 5/-; Telsen dual range coils, with aerial series condenser incorporated, type W76, 4/-; Telsen aerial condensers, with shorting switch, 2/-; all Telsen components brand new, in sealed cartons.
AMERICAN Valves.—A full range of valves for all American receivers; 6/- each.
MISCELLANEOUS Bargains.—All brand new, in original sealed cartons; Telsen A.C./D.C. multi-meters, test anything, radio or electrical, 8/6; Telsen 2-range voltmeters, 3/-; 3-range meters, including milliamps, 4/-; Ace (P.O.) microphones, with transformer, ready for use with any receiver, 4/6; Bell transformers, 200-250 volts input, 3, 5, or 8 volts output, 3/6; Morse signal units, incorporating buzzer, tapper and flash, with international code, complete with batteries and bulb, 3/9 each; lightweight headphones, double-pole, 4,000 ohms each earpiece, 3/- pair.
EGENTONE Eliminators, A.C. 200-250 volts, type R W5a, with trickle charger; 37/6.
SOUTHERN RADIO.—Branches at 271-275, High Rd., Willesden Green, N.W.10; 46, Lisle St., London, W.C.2. All mail orders to 323, Euston Rd., London, N.W.1.
SOUTHERN RADIO, 323, Euston Rd., London, N.W.1 (near Warren St. Tube). Phone: Euston 3775. [4192]

**COMPONENTS—SECOND-HAND,
CLEARANCE, SURPLUS, ETC.**

RYALL'S RADIO, 280, High Holborn, London, W.C.1, offer new goods at knock-out prices.
AMPLIFIER, with 6-watt output, 3-stage, for A.C. 200-250v., splendid chassis, Ferranti transformer, complete with 5 valves; 50/-.
3-GANG Condensers, "straight type" 0005, die cast frames, small size ex Cosor, fully screened, trimmers top, 2/9; Plessey ditto, large or small piano type, 4/6.
CLYDON Trimmers, sizes 50 mm., 70 mm., 140 mm.; 4d. each, or 2/9 dozen.
FERRANTI Coils, screened H.F., single wound, three band reaction on short wave only, with top trimmer; 1/3 each.
PLESSEY Twin Gang, fully screened with top trimmers, 0005, 3/9; ditto, semi screened, midget type, 2/9, correct hand.
CENTRALAB Volume Controls, 1/2-meg., 1/-; Centralab 11,000 ohm, 9d. each; N.S.F. 15,500 ohm, with mains on-off switch, 2/3.
T.C.C. Electrolytics, tubular can type, dry, 16x8 mfd. 450v., 1/7; 8x4 ditto, post extra on this line. [4310]
N.S.F. 0.1 Tubular Non-inductive 1,000v. Test Condensers, 2/6 dozen, tag ends; 0.01 ditto N.S.F. 25x25 mfd., six for 3/-, tubular, wire ends.
PAIRS Matched Ferranti Screened Coils, aerial and H.F., with reaction, sensitive and selective; 2/6 per pair, chassis type.
FERRANTI Mains Transformers, as used in their own commercial receivers, 350-0-350v., 70 m.a., 4v. 2 1/2a., 4v. 4-5a., C.T. input 200-250v., brand new; 6/6 each. [4292]
FOR Sale, cheap, used but perfect speakers, components, valves; send for list.—Ashton, Byass Av., Bridlington. [4310]
MAINS RADIO DEVELOPMENT COMPANY Offer Guaranteed Bargains; carriage paid, call mornings.—Phone: Tudor 4046. Stamp for new list 203.
MAGNUM Fully Screened Three-wave Band Superhet. Coils, and I.F. transformers, surplus to set maker; latest type grey cellulose cans, trimmers on all wave bands, 15-52, 190-560, 800-2,200 metres; aerial (for pre H.F.), H.F. and oscillator (465 k/c); three coils, two 465 k/c I.F.'s, and three-gang Yaxley type switching; complete kit, with circuit diagram, 25/-; without I.F. transformer, 17/6.
ERIE Surplus Quarter Watt Resistors, unused, colour coded, wire ends, two each of six good sizes, our choice; 1/- dozen.
SATOR Metal Cased Condensers, 400 volt working, 1 mfd., 7 1/2d.; 2 mfd., 10d.; 4 mfd., 1/8.
CENTRALAB Unused Potentiometers, 500,000 ohms, 1/3; 10,000 ohms, 1/3; Cosor 50,000 ohms, 1/3; Rotorhm, 10,000 ohms with switch, 1/6; Centralab, 500,000 ohms with switch, 1/9; any other size in Centralab, with or without switch, 2/3.
B.I.C. 8 mfd., 550 volt dry, metal can electrolytics, 2/3; ten other sizes on list.
PYE 20h., 120 m.a., boxed L.F. chokes, 4/6; Arco steatite short wave condensers, 0.00016 mfd., 1/6.
TUBULAR Condensers, very best make, wire ends, 400 volt working, 0.0001, 0.002 mfd., 3d.; 0.005, 0.05 mfd., 5d.; 0.25, 0.5 mfd., 7d.; special 0.1 mfd., 450 volt working, 5d.
CLIX Latest Unused Chassis Valve Holders, 4-pin, 1 1/2d.; 5-pin, 2 1/2d.; 7-pin, 4d.; chassis, grey cellulose metal, three valve, 12x6x6 1/2x3in., 1/- (9-pin, 6d.).
RESISTORS absolutely finest make, one watt, colour coded, wire ends, unused, 50 ohms to 5 megohms, any size, your choice, 3 1/2d., 2/9 dozen; two watt, 4-6, 4-6.
MAINS RADIO DEVELOPMENT COMPANY, 4-6, Manswell Hill Rd., London, N.6. [4318]
RECORDS.—1,700 Celebrity Polydor, H.M.V., Columbia, Parlophone, Decca, Brunswick, Hot Rhythm, etc.; new recent numbers from 6/- to 20/- dozen.—Farnell, 12, Heaton Park Rd., Bradford. [4308]
RESISTANCES, 1 watt, colour coded, 2/6 doz., 50 to 100,000 ohms, well known make, finest grade; 1/6 half doz., all useful sizes, our choice.—City Radio (Short Wave Specialists), 174, Norfolk St., Sheffield. [4332]
FERRANTI M.I. P.M. Speaker, 22/10; Hartley Turner Twin Cone, field 2,500, 23/10; B.T.H. R.K. speaker M.C., 10in. cone, with H.T.8 metal rectifier, 35/-; all in new condition; carriage 2/6.—R.P.R. Radio, 112, Pentonville Rd., London. [4333]
STANDARD RADIO SUPPLIES.—All lines advertised last week still available. Traders please note, T.C.C. upright condensers, all at 1/6 dozen, 0.025, 0.4 0.005, 0.125, 0.2, 0.004, 0.001, 0.003.—Standard Radio Supplies, 1, Dantzic St., Manchester, 4. [4335]
NEON Tuners, pin base, 1/9; S/H 500,000 ohm volume control, W/F switch, 9d.; T.C.C. electrolytic condensers, 16 mfd. 2/6, 8 mfd. 2/3; 25-volt 25 mfd. 1/3; large selection of component parts in stock; 10% discount on orders of £1.—Radio Trade Service, 48, Hetley Rd., Shepherd's Bush, W.12. (She. 3567). [4276]
PRIVATE Bargains, must sell.—Ferranti 3 range m.A. meter, 0-7.5, 0-30, 0-150; Ferranti intervalve transformer, 1/7; Ferranti electric fire, 2 1/2 k.w. 230 volts; Colvern coils, G.1, 2 and 3; 2 Ferrocat triple unit iron cored coils; 2 3-gang condensers; oddments; best offers secure.—Bryant, 2, Ridgway Place, Wimbledon, Wim. 4230. [4355]
GRAMOPHONE Attachments for Radio.—Electric motors, 25/-; pick-ups, 9/6; portable gramophones, 12/-; spring motors, 4/6, dozen 36/-, 100 12/10, 1,000 10/10; walnut pedestal Anexagram, 25; soundboxes, tone arms, horns, cabinets, needles, gears, springs, accessories cheapest; quantity buyers obtain lower prices; catalogue free.—Regentworld, 120, Old St., London, E.C.1. [4213]
TRANSMITTING APPARATUS
GSNI.—The recognised distributors for amateur equipment, National, R.M.E., Thordarson, Hammarlund, McMurda, Iallicrafters, etc.; send 1 1/2d. stamp for catalogue.—Radiomart, 44, Holloway Head, Birmingham. [0531]
MISCELLANEOUS
CHEAP Printing.—1,000 billheads, 3/6; sample free.—Creteway Press, 18, Buxted, Sussex. [4312]
G.P.O. Engineering Dep. (no experience required); commencing 23/13 per week; age 18-23; excellent prospects.—Free details on Entrance Exam. from B.I.E.T. (Dept. 574), 17-19, Stratford Place, London, W.1. [4160]

RAYMART
CRAFT A CREED

COIL FORMS. Apart from the



attributed to R.D.4 dielectric as employed in our range of Coil forms other outstanding features are thin walls and ribs minimising losses. To prevent instability and loss of calibration due to loose winding, threading is effected in a deep continuous spiral. The avoidance of noisy operation caused through high resistance contacts is attained by passing the winding wires through hollow resilient pins thus permitting these wires to be soldered to the ends of the pins. These "R.D.4" loloss dielectric coil forms are fitted with coloured disc in top for easy identification.

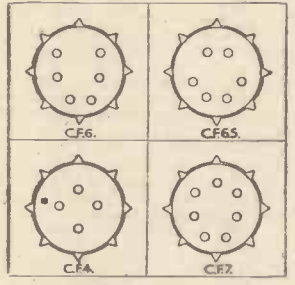

OUR SHORTWAVE MANUAL.

49 pages on receivers, transmitters, modulators, aerials, etc., etc., 6d.
OUR SHORTWAVE CATALOGUE 14d.
 The pair sent post free for 7 1/2d.

- CF4 (4 pin) ... 1/6
- CF6 (6 pin) ... 1/9
- CF6S (Standard 6 pin)... 1/9
- CF7 (7 pin) ... 1/10
- CT4 threaded ... 1/8
- CT6 " " ... 1/11
- CT6S " " ... 1/11
- CT7 " " ... 2/-

(7 pin type allows bandspread tap to be fitted.)

MICROVARIABLES.—All brass construction, latest ceramic insulation The finest condensers made: 15 mmfd., 1/4; 40 mmfd., 1/7; 100 mmfd., 1/10; Transmuting Type.—070in. spacing, 15 mmfd. (neutralising), 2/8, 40 mmfd. Tuning, 3/6. These are quality.
SHORTWAVE COILS.—(R.D.4), CA 11-25, CB 20-45 metres, 2/8. CC S 44-100 metres, 2/9. Standard 6-pin types, CA6, CB6, 2/9 each; CC6, 3/-; same range as 4-pin.
COILFORMS.—Moulded in R.D.1 natural loloss material, hollow resilient pins, 1 1/2in. diameter, ribbed; identification disc in top. Four types, 4-pin, 1/6; 6-pin (standard or to fit 7-pin valveholders), 1/9; 7-pin (for bandspread tap), 1/10; Machine threading, 2d. extra.
AMERICAN Mains Transformers, 230 v. primary, fully shrouded, 350-0-350, 6.3 v., 5 v., 6/11; Ditto, heavy duty up to 10 valves 150 m.a., weight 8 lbs., 12/8; Majestic, 250-250 2.5 v., 5 v., 4/11; Pilot 260-260, 2.5 v. C.T., 5 v. C.T., 5/11. Ceramic American Valveholders, 1/- each.
HEAVY DUTY Mains Transformer, worth 35/-, 350-350, 150 m.a., 4 v., 2.5 A.C.T., 4 v., G.A.T. 12/8; Philips 270-270, 120 m.a., same LT's, 6/8; Speaker Transformers, 2/6.
UTILITY 8/6, Microdisc Dials, 3/11; Radiophone, 0.00016 Shortwave Condensers, 3/6; Series gap twin, 3/9. Shortwave HF Chokes 5-100 metres, 6d.
EC Litz Wound I.F., 3/11; Two-speed slow-motion knobs, 1/-; Telsen Ace Transformers, 1/11; Telsen Screened S.W. H.F.C., 1/-; Iron core H.F. chokes, 1/-.
ELECTROLYTICS. Huge purchase 500 v. Aluminium Can, 4 mfd., 1/6; 8 mfd., 1/11; 8+8 mfd., 2/6; Block type, 500 v. peak, 4+4 mfd., 1/6; 8+8+4 mfd., 3/-; 50 mfd. 50 v., 1/8; 25 mfd. 25 v., 1/-; Tubular Condensers, 1500 v. T., all sizes to 0.1 mfd., 6d.; 0.2 to 0.5 mfd., 8d.
FAMOUS CONTINENTAL A.C. Valves, 4/6; Battery types from 2/3; American Duotron, etc., all types, 3/6; All types of RCA Licensed first grade tubes, metal and glass, in stock from 5/6.
BRITISH RADIOPHONE. 0005 straight or superhet 3-gang fully screened condensers with trimmers, 4/11; Utility Midget 2-gang ditto, 3/11; S.L. Dial to suit above, 2/11; Utility 2-gang Ukisnob, 0005 with Dial, 3/11.
PUSHBAC Wire, 6 yds., 6d.; heavy, 9d.; Resin-cored Solder, 6in., 6d.; Screened Flux, single, 6d. yd.; twin, 9d. yd. Assorted Solder Taps, 6d. packet.
SMOOTHING CHOKES, 20 hy., 120 m.a., 3/11; 200 m.a. swaging chokes, 8/8; Centralab Pots, all sizes, 1/8; switched, 2/-; 20,000 ohm Pots, 1/-; Tubular glass tubes, 24. Milliammeters, 25 m.a. upwards, 5/9; super, 6/9.
SPECIAL OFFERS. Class B Kit, worth 30/-, comprising Driver Transformer, Valve and Holder, 5/-; Dozen wire-ended assorted resistors, 1/8; Order 5/- post free. Get our Bargain Catalogue, 14d. post free. All enquiries and requests for Catalogue must send 1d. stamp.

BIRMINGHAM RADIOMART (GSNI)
 44, HOLLOWAY HEAD,
 BIRMINGHAM. TELE: MID. 3254

TANNOY
THE SOUND PEOPLE

FOR GUY R. FOUNTAIN LTD.,
 CANTERBURY GROVE, WEST NORWOOD,
 LONDON, S.E.27. Phone: Str. 4122 (6 lines).
ALL SOUND AMPLIFYING EQUIPMENT

MOTOR CYCLE

The Motor Cyclist's Newspaper
EVERY THURSDAY—3d.
 Publishers: ILIFFE & SONS LTD., Dorset House,
 Stamford Street, London, S.E.1 w.w.15

"Radio Data Charts," A Series of Abacs Post free 4/10

REPAIRS AND SERVICE

GRAHAM'S. GRAHAM'S Radio, Repair and Rewinding Service; 24 hours' service guaranteed.—See below. ALL Moving Iron Loud Speakers, L.F. transformers, or pick-ups, from 2/6, output transformers from 4/-; postage extra; mains transformers, moving coils, electric clocks quoted, trade discounts.—Graham's Repairs, 194, Tolworth Rise, Kingston By-pass, Surrey. 'Phone: Derwent 2060. [4141]

DISTAVOX SERVICE. GUARANTEED Service.—All makes of English and American receivers; quotation by return. REWINDING.—Mains, L.F. and output, transformers, speakers, headphones, etc.; keenest terms for contracts.

DISTAVOX RADIO SERVICE Co., 119, Bunhill Row, London, E.C.1. 'Phone: National 8589. [4142]

SCOTT, SESSIONS and Co., ALL British or American Sets Repaired or Modernised by Qualified Engineers; satisfied customers throughout the world are your guarantee; send to-day for free estimate; free collection 10 miles radius of London.—Scott Sessions and Co., Exchange Works, Dukes' Av., Muswell Hill, London, N.10. 'Phone: Tudor 4101. [0552]

"SERVICE WITH A SMILE." HENRY FORD RADIO, Ltd.—American valves, components, spares, line cords; leading trade repairers; send us your American and British receivers.—Electronic House, 22, Howland St., Tottenham Court Rd., W.1. Museum 5675. [0434]

METROPOLITAN RADIO SERVICE Co., for Guaranteed Repairs to American (Midget and Standard and British Receivers) CLARION and Majestic Service Depot.—L.F. and mains transformers rewound. American valves and parts; trade supplied.—Metropolitan Radio Service Co., 1021, Finchley Rd., London, N.W.11. Speedwell 3000. [0435]

REPAIRS, rewinds, and construction, any size transformers, chokes, etc., to trade.—Felectric, Garden St., Sheffield, 1. [3915]

FOR Unusually Good Rewinding of Transformers, chokes, speakers, etc., trade only.—Gardners Radio, Ltd., West Southbourne, Bournemouth. [0551]

OUR Technical Department is at your Service.—Air King Radio, 115, Shaftesbury Av., Cambridge Circus, W.C.2. 'Phone: Temple Bar 4875 (2 lines). [3963]

LOUD Speaker Repairs, British, American, etc.; any make transformer coils rewound; alterations.—Sinclair Speakers, Alma Grove, Copenhagen St., N.1. [4030]

NATIONAL RADIO and TELEVISION SERVICE Co., Leading Service Engineers and Car Radio Experts. 155-157, Great Portland St., W.1. 'Phone: Langham 3477. [3911]

GUARANTEED Repairs. — Any transformers, choke, motor, armature, converter, dynamo, etc.; keenest prices, immediate quotation; prompt, dependable service.—See below.

L.T.P. (LONDON TRANSFORMER PRODUCTS, Ltd.), Willesden, N.W.10. Willesden 6486 (3 lines). [3470]

POULTNEY and PURVIS, British and American Service, trade or private; "W.W." sets a speciality; free collection, estimates.—147, Pithanger Lane, Ealing, W.5. Perivale 3765. [4147]

MAINS Transformer Service.—Repairs, rewinds, or constructions to specification of any type; competitive prices and prompt service.—Sturdy Electric Co., Dip-ton, Newcastle-on-Tyne. [0516]

F. E. GODFREY, A.M.I.R.E., qualified to build, repair and convert "Wireless World" sets, etc.; 25 years' experience, prompt service guaranteed.—30, Kempsey Rd., Hampstead, Hampstead 1104. [3509]

REPAIRS to Moving Coil Speakers a Speciality; cones and coils fitted, fields altered; prices, including eliminators, quoted, loud speakers, 4/-; L.F. and output transformers, 4/-, post free; guaranteed satisfaction; trade invited; estimates free; prompt service.—Loud-Speaker Repair Works, 5, Balham Grove, London, Battersea 1321. [0394]

EXTENDED PAYMENTS

LONDON RADIO SUPPLY Co. (Established 1925) supply on convenient terms, components, accessories and sets, any make, 10% down, balance over 12 months; send for list of requirements.—11, Oat Lane, London, E.C.2. [0537]

HIRE-PURCHASE.—Prompt delivery of any radio apparatus on convenient terms. WARD, 46, Farringdon St., London, E.C.4. Tel.: Holborn 9702. [0539]

ELECTRIC CLOCKS

SMITHS and Ferranti Electric Clocks, Waltham and Russell watches and clocks; traders' enquiries invited.—Leonard Heys, 36, Henry St., Blackpool. [0526]

EXCHANGE

I BUY, sell, exchange good quality receivers, accessories, components; H.P. facilities; promptness, efficiency.—Bostock, 1, Westbourne Terrace, S.E.23. Forest Hill 2236. [0529]

PATENT AND TRADE MARK AGENTS

GEE and Co. (H. T. P. Gee, Mem. R.S.G.B., A.M.I.R.E., Estab. 1905), 51-52, Chancery Lane, London, W.C.2 (2 doors from Government Patent Office). Holborn 4547 (2 lines). Handbook free. [0001]

PATENTS

IT is desired to secure the full commercial development in the United Kingdom of British Patents Nos. 379,299 and 388,462, which relate to the Improvements in Electrolytic Cells, either by way of sale or the grant of licences on reasonable terms.—For particulars apply Phillips's, 70, Chancery Lane, London, W.C.2. [4317]

BARGAINS

New Times Sales Co. (Est. 1924) offer the Short Wave Fan remarkable opportunities to secure NEW Short-wave Kits, Assembled Chassis and Components at bargain prices.

KITS

NEW "3-in-1" S.W. KIT Combined Adaptor-Converter—1-Valve Short-wave Receiver, 12-94 Metres. KIT No. 1. Including 3 Coils, drawings and instructions. List Value £117/6. Bargain 25/-, or 2/6 down and 10 monthly payments 2/6.

NEW 2-VALVE BANDSPREAD S.W. KIT, 12-94 metres. Kit No. 1. Including 3 Coils, drawings and instructions. List Value £29/6. Bargain 32/6, or 2/6 down and 11 monthly payments 3/-.

NEW 3-VALVE BANDSPREAD S.W. KIT, 12-94 metres. Kit No. 1. Including 3 Coils, drawings and instructions. List Value £30/0. Bargain 37/6, or 2/6 down and 11 monthly payments 3/6.

NEW 4-VALVE BANDSPREAD S.W. KIT, 12-94 metres. Kit No. 1. Including 3 Coils, drawings and instructions. List Value £39/6. Bargain 42/-, or 2/6 down and 11 monthly payments 4/-.

NEW DX FANS' SHORT-WAVE A.C.3 KIT, 12-94 metres. For A.C. Mains. 200-250 volts. Kit No. 1. Including 3 Coils, drawings and instructions. List Value £510/0. Bargain 75/-, or 5/- down and 11 monthly payments 7/-.

ASSEMBLED CHASSIS

6-VALVE ALL-WAVE ALL-MAINS SUPERHET CHASSIS. Fully assembled and complete with 6 Valves and Field-Energised Moving-Coil Speaker. Wavering 18.5-2,100 metres. For A.C./D.C. Mains. 100-200 volts. List Value £107/6. Bargain £6:19:6 Or 10/- down and 12 monthly payments 12/-.

COMPONENTS

N.T.S. Short Wave Coils.—Three ranges: 12-26, 22-47, 41-94 metres; 4-pin. List Value, 2/9. Bargain, 1/9 each. 6-pin: List Value, 3/6. Bargain, 2/- each. Coil Bases. 4-pin. 1/-; 6-pin, 1/6. 10:1 Slow Motion Dial.—Illuminated Scale 0-180. With escapement and knob. List Value, 2/8. Bargain, 1/9. Bandspread and Tuning Condensers.—For all short and ultra-short wave circuits. Type 3.16 .00016 mfd. List Value, 3/9. Bargain, 3/6. Type 4/16 .00016. List Value, 4/9. Bargain, 2/9. Slow Motion Reaction Condenser.—For utmost amplification from reacting detector circuits. Type No. R3/20 .0002 mid. List Value, 7/6. Bargain, 5/-.

L.F. Transformer.—High permeability core, low self-capacity windings. Type LF13, ratio 1:3; Type LF15, ratio 1:3. List Value, 8/6. Bargain, 4/-.

Headphones.—With lightweight head-band, two ear-pieces each 2,000 ohms resistance. Total weight, 4½ ozs. List Value, 35/7. Bargain, 7/6.

Orders over 10/- post free. Orders under 10/- post and packing 6d. ex.

Write to-day for Free Booklet, describing in full, with illustrations, these Bargain Offers, including prices and terms of the above Short Wave Kits complete with Valves, Headphones and Moving Coil Speaker.

FREE! NEW TIMES SALES Co., 56 (W.W.1), Ludgate Hill, London, E.C.4. EST. 1924.

IS YOUR SET PERFECTLY TUNED?

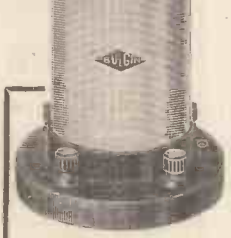

Though the components are faultless you may be losing sensitivity through mistuned I.F. Transformers. Get them right! It is easily done with this instrument made for that very purpose.

465 kc/s I.F. LINER

SELF-CONTAINED, consuming but a fraction of a millilamp, this handy gadget will take the place of an expensive modulated test oscillator. Plugged in to any D.C. supply of 200 volts or over—or even run off an A.C. set's own rectified H.T.—it renders both easy and quick the skilled, important job of re-trimming Intermediate Frequency Transformers. A workshop instrument which the Serviceman or Experimenter simply must add to his kit!

PRICE 14/7

LIST NO. V.T. 17.

To A. F. Bulgin & Co., Ltd., Abbey Road, Barking, Essex.

Please forward me a copy of your complete catalogue No. 156, for which I enclose 3d. in stamps.

Name.....

Address.....

W

SEND THIS COUPON

TUITION

RADIO Training.—Marine, aircraft, broadcast; prospectus free.—Hull Municipal Technical College. [0523] PRACTICAL Radio and Television, private or postal training; particulars free.—R.T.I. 39-47, Earl's Court Rd., W.8. Western 6917. [3758]

WANTED

WANTED, all types modern radios, chassis and apparatus.—Write H. R. Radio, 41, Hetley Rd., London, W.12. [4248]

WANTED, good 0-1 (approx.) M. ammeter, calibrated 100 divisions or Universal Avometer, cash.—Bangay, R.A.F., Finningley, Yorks. [4356]

WE Buy for Cash All Types of Modern Second-hand Radio Sets and Accessories, test meters, parts, etc.; we pay more than any other dealer; part exchanges; bring, send, or will call.—University Radio, Ltd., 82, Hampstead Rd., London, N.W.1. 'Phone: Euston 3810. [4193]

SITUATIONS VACANT

AIR MINISTRY.

DIRECTORATE of Technical Development.

ASSISTANT'S Grade III (Ref. A.4701) Required at the Royal Aircraft Establishment, South Farnborough, Hants, for work in connection with the development of wireless apparatus.

CANDIDATES Should Have Technical Training in Electrical Engineering, and some workshops, drawing office, or laboratory experience.

SALARY Scale.—£130 a year, rising to £310 a year, but the commencing salary will be determined according to qualifications and experience; for entrants below the age of 19 the normal commencing salary of £130 will be reduced by £10 for each year or part of a year below 19.

PROMOTION to Assistant II (£315 to £385) and Assistant I (£400-£515) is governed by merit, and is dependent upon vacancies.

THE Appointments will be non-pensionable, but entrants will be eligible for consideration for appointments to pensionable posts in the event of vacancies arising on the permanent establishment.

APPLY, quoting Ref. A.470, and stating age and full particulars of training and experience to the Chief Superintendent, Royal Aircraft Establishment, South Farnborough, Hants. The closing date for the receipt of applications is 14th May, 1937. [4314]

AIR MINISTRY.

DIRECTORATE of Technical Development.

APPLICATIONS are invited for an Appointment as Senior Technical Officer and Technical Officer, at the Royal Aircraft Establishment, South Farnborough, Hants.

REFERENCE No. 5671.—The Senior Technical Officer is to be appointed to carry out and supervise development and experimental work in connection with aircraft radio-communication equipment; candidates should possess an honours degree in electrical engineering, science, or mathematics, and have had extensive experience in radio experimental development work, preferably with a large engineering organisation; experience in an administrative or supervisory capacity is desirable, and knowledge and experience of measurement and receiver design would be an advantage.

REFERENCE No. 2431.—Technical Officer for experimental work in connection with ground and aircraft radio direction finders; candidates should possess a theoretical knowledge of physics and mathematics and have had training in radio engineering to B.Sc. honours degree standard, with subsequent experience of radio experimental work; knowledge and experience of the technique of direction finding is essential.

SALARY Scales:—

SENIOR Technical Officer.—£680 by £25 annually to £800. (Women £550-£18-£650.)

TECHNICAL Officer.—£455-£25-£580. (Women £356-£18-£464.)

CANDIDATES Should be Physically Fit for Flying, and willing to fly as observers.

PROMOTION to the Higher Posts of Principal Technical Officer (£850-£30-£1,010) is governed by merit as and when vacancies occur; the appointment will be non-pensionable, but entrants will be eligible for consideration for appointment to pensionable posts in the event of vacancies arising on the pensionable establishment; application should be made on a form to be obtained (quoting appropriate reference No.) from the Chief Superintendent, Royal Aircraft Establishment, South Farnborough, Hants, to whom it should be returned not later than 14th May, 1937. [4313]

RADIO Service Engineer Required.—Write Box 1660, c/o The Wireless World. [4315]

SERVICE Engineer for Valve Deaf Aids, responsible man, able to handle good class clientele, London, W.1.—Box 1707, c/o The Wireless World. [4357]

RADIO Sales Clerk Required, also youth as shorthand typist, excellent future for technically minded and intelligent young men.—Box 1692, c/o The Wireless World. [4319]

PROFITABLE Sideline, carrying generous commission, a few districts still open for technical men with trade connections; selling freely everywhere.—Box 1701, c/o The Wireless World. [4352]

RADIO and Television.—Wanted, first class testers with factory experience, able to diagnose faults quickly and accurately; write, stating experience, age and salary required.—Box 1567, c/o The Wireless World. [4258]

CLASS Expert Required, to take charge of glass section in radio valve factory (Manchester district), experience of glass machines for valves or lamps essential.—Send full particulars to Box 1648, c/o The Wireless World. [4311]

RADIO Valve Experimental Assembly Maker Required (Manchester District), experience on valve work essential.—Reply giving age, qualifications, previous employers and wage expected to Box 1569, c/o The Wireless World. [4260]

WIRELESS Operators and Engineers Urgently Required.—Train at Britain's leading colleges; fee after appointment; boarders; prospectus free.—The Wireless College, Colwyn Bay, or The Wireless College, Calmore, Southampton. [0541]

APPLICATIONS are Required from Keen Young Men who have Received and are Receiving First Class Technical Education in Radio and Electrical Engineering, to serve as trainees in test department, for radio and transmitting apparatus.—State age, details of education and experience, etc., to Box 1672, c/o The Wireless World. [4320]

INDEX TO ADVERTISEMENTS

PAGE	PAGE	PAGE
All-Power Transformers, Ltd.	Fluxite 4	Parmeko, Ltd.
Automatic Coil Winder Co., Ltd.	Forbat, Eugene J.	Peto-Scott, Ltd.
Baker's Selhurst Radio 3	Galpin's Electrical Stores 2	Player's Cigarettes
Belling-Lee, Ltd.	Gardners Radio, Ltd.	Postlethwaite Bros.
Birmingham Radiomart G5N1 6	Goodmans, Ltd.	Premier Supply Stores
British Institute of Engineering Technology 2	Grampian Reproducers, Ltd. 5	Record Radio, Ltd.
British Insulated Cables, Ltd.	Hartley Turner Radio, Ltd. 1	Savage, W. Bryan 2
British Pix 8	Haynes Radio Front Cover	Scott Sessions, Ltd.
British Rola Co., Ltd. Edit. 435	Henley's W.T. Cable & Wireless Works Inside Front Cover	Shaftesbury Microphones
British Sound Reproducers, Ltd. 8	H.M.V.	Sound Sales, Ltd. 4
British Thomson-Houston Co., Ltd. 2	Institute of Wireless Technology	Stern, S.
Bulgin, A. S. & Co., Ltd. 7	Lectro-Linx, Ltd.	Tannoy Products 6
C.A.V.	McCarthy Radio, Ltd. Front Cover, Edit. 431	Telegraph Condenser Co., Ltd. Edit. 433
Colvern, Ltd.	Midwest Radio, Ltd.	Universal Radio Distributors, Ltd.
Cossor, A. C., Ltd.	M.P.R. Electrical Co.	Ward, C. F. 2
"Drydex" Front Cover	M.R. Supplies 7	Webb's Radio 2
Dubilier Condenser Co. (1928), Ltd. Front Cover	New Times Sales Co.	Westinghouse Brake & Signal Co. 5
Electradix Radios 2, 4		Wright & Weaire, Ltd. 5
Exide, Ltd.		



Amazing New 50 Watt Amplifier

**50 Watts (U.D.O.) from
12 v. Car Battery or A.C. Mains**

Consumption 12 Volts 9 Amperes.

★

Think of it! 50 Watts High Fidelity Undistorted Output, using only a Car battery with a drain of 9 amperes (switch over to A.C. mains if desired). Truly amazing! This New B.S.R. Public Address Amplifier sets a new standard. Specially designed in the B.S.R. Laboratories and embodying a special circuit, it gives performance that leaves orthodox circuits in the background.

*Entirely new design
Special B.S.R. Circuit.*

Send for particulars. Only a limited number available before the Coronation. Deliveries in rotation. Remember — B.S.R. quality, reliability, high efficiency and economy.

BIRMINGHAM SOUND REPRODUCERS Ltd.,
CLAREMONT WORKS, OLD HILL, STAFFS. Phone: Cradley Heath 6212/3.
Telegrams: "Electronic, Old Hill."

Second Edition—

RADIO DATA CHARTS

A SERIES OF ABACS

providing most of the essential
Data required in Receiver Design.

By **R. T. BEATTY, M.A., B.E., D.Sc.**

Published from the Offices of
"THE WIRELESS WORLD"

"Radio Data Charts" provide designers of wireless apparatus with a ready and convenient means of solving problems without having recourse to complicated formulæ and mathematics.

By the use of the new "Radio Data Charts" such abstruse problems as the design of tuning coils are solved almost as easily as the simple application of Ohm's Law.

Price 4/6 net By post 4/10

From leading booksellers or direct from the publishers.

ILIFFE & SONS LTD.
Dorset House, Stamford Street, London, S.E.1
W.W.93

RADIO RECEIVER MEASUREMENTS

By Roy M. Barnard, B.Sc., A.M.I.R.E.

A concise handbook of practical value to the radio service engineer as well as to the amateur experimenter. Complete with fifty-three illustrations and diagrams, summaries of method, four appendices and a general index.

PRICE **4/6** net. By post 4/9

From all booksellers or direct from the Publishers **ILIFFE & SONS LTD., DORSET HOUSE, STAMFORD STREET, LONDON, S.E.1**
W.W.19.

£1000 FREE INSURANCE

Enjoy the feeling of complete security in the worst storms by fitting a **PIX ARRESTOR**. One of the largest Insurance Institutions insures you against the risk of personal damage up to **£1,000 and £30 FOR THE SET**

They have satisfied themselves that with the **PIX ARRESTOR** the risk is NIL.

PIX, LONDON, S.E.1.



PIX LIGHTNING ARRESTOR

2/-

Printed in England for the Publishers, ILIFFE AND SONS LTD., Dorset House, Stamford Street, London, S.E.1, by The Cornwall Press, Ltd., Paris Garden, Stamford Street, London, S.E.1. "The Wireless World" can be obtained abroad from the following: FRANCE: W. H. Smith & Son, 248, Rue Rivoli, Paris; Hachette et Cie, Réaumur, Paris, and branches. BELGIUM: W. H. Smith & Son, 74-75, Boulevard Adolphe Max, Brussels. AUSTRALIA: Gordon & Gotch, Ltd., Melbourne (Victoria), Sydney (N.S.W.), Brisbane (Queensland). ADELAIDE (S.A.), Perth (W.A.) and Launceston (Tasmania). NEW ZEALAND: Gordon & Gotch, Ltd., Wellington, Auckland, Christchurch and Dunedin. INDIA: A. H. Wheeler & Co., Bombay, Allahabad and Calcutta. CANADA: Imperial News Co., Toronto, Winnipeg and Vancouver; Benjamin News Co., Montreal; Gordon & Gotch, Ltd., Toronto. SOUTH AFRICA: Central News Agency, Ltd., UNITED STATES: The International News Co., New York.

SECOND EDITION

—THOROUGHLY REVISED

WIRELESS SERVICING MANUALBy **W. T. COCKING***(of "The Wireless World")*

The first complete book of reference of its kind. A reliable practical guide for amateur and professional.

The demand for this book was so great that the first edition was sold out in the short space of a very few months. A second edition containing additional material is now on sale. The "Wireless Servicing Manual" deals fully with Testing Apparatus and explains the methods of locating and curing faults in receiving equipment.

Ganging, Automatic Volume Control, Instability, Distortion, Mains Hum, Whistles and Local Interference are all separately treated.

The new edition contains much additional information on short-wave receivers, and on methods of operating extension loud speakers, the reference material including base-connections for British, Continental and American Valves and the various colour codes for components has been extended and brought up to date

BOUND IN CLOTH BOARDS

SIZE 7½ ins. x 5 ins.

231 PAGES

PRICE 5/- net. By post 5/4

Issued in conjunction with "THE WIRELESS WORLD" and Published by the Proprietors—

ILIFFE & SONS LTD., DORSET HOUSE, STAMFORD STREET, LONDON, S.E.1

W. W. 20

**FOUNDATIONS
of WIRELESS**

*A Book of
First Principles
for the
Wireless
Enthusiast*

PRICE 4/6 NET

By Post 4/11

Issued in conjunction with
"THE WIRELESS WORLD"
and published by the Proprietors—

By **A. L. M. SOWERBY, M.Sc.**

An Elementary Text Book on Wireless Receivers

"Foundations of Wireless," based on a series of articles which appeared in "The Wireless World," covers the whole field of wireless from the simplest electrical phenomena to the construction of a modern set, and all the vital points in receiver design are treated in full detail. Chapters are devoted to direct and alternating currents; typical circuits; the properties of inductance and capacity; the nature of high frequency currents; the tuned circuit; and amplification by the valve.

Eleven of the eighteen chapters of the book deal with the discussion of receivers, in which the whole process of design is reviewed stage by stage to the finished article.

Special attention is paid to the important subject of tuned circuits and band-pass filters, on the correct design of which the performance of every type of set ultimately depends. Moreover, the process of detection, so often imperfectly understood, is clearly explained.

ILIFFE & SONS LTD., DORSET HOUSE, STAMFORD STREET, LONDON, S.E.1

Mention of "The Wireless World," when writing to advertisers, will ensure prompt attention.

The Autocar

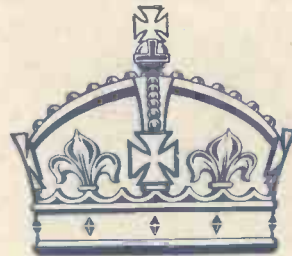

CORONATION NUMBER

This great issue, designed to be worthy of an historic occasion, is the finest of all special numbers produced by "The Autocar." Printed in four-colour, two-colour and photogravure it contains articles reflecting forty-two years of automobile evolution.

42
YEARS
OF
MOTORING

PRINCIPAL CONTENTS

PORTRAITS OF THEIR MAJESTIES THE KING AND QUEEN

In full colour; specially painted for "The Autocar" by Algernon Rowe.

THIS HERITAGE

The countryside of England illustrated in full colour by R. E. Poulton.

1895-1937

Biographies of the leading firms in the British Motor Industry.

FROM HORSELESS CARRIAGE TO MOTOR CAR

The development of motor-car coachwork during the life of His Majesty the King.

THE KING AND HIS PASTIMES

SOME LONDON CAMEOS

For the motorist visiting London for the Coronation.

EIGHT PAGES OF PHOTOGRAVURE

Pictures of the Coronation Race at Crystal Palace, photographs of the Royal Residences, and of Coronation events and illuminations.

HOW TO SEE THE CORONATION

Traffic restrictions and routes with maps and particulars of garages.

THE KING'S GARAGE AND MEWS

Illustrated by photographs specially taken by "The Autocar."

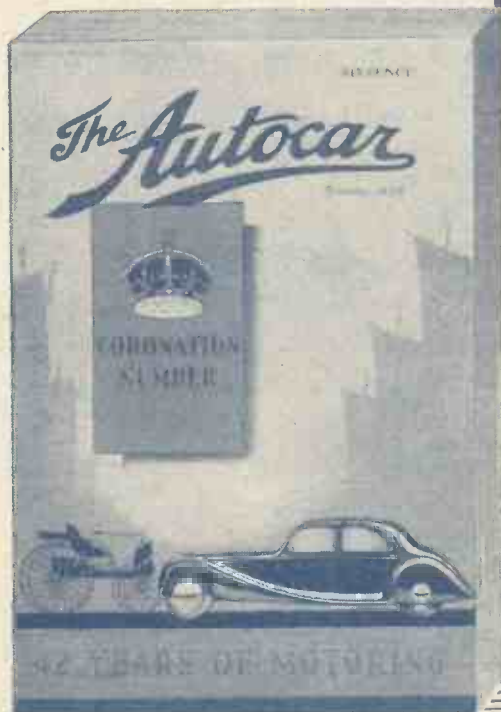

NOW ON SALE—6d.

ILIFFE & SONS LTD.,
DORSET HOUSE, STAMFORD STREET, LONDON, S.E.1